

Your Industry. Our Indicators.

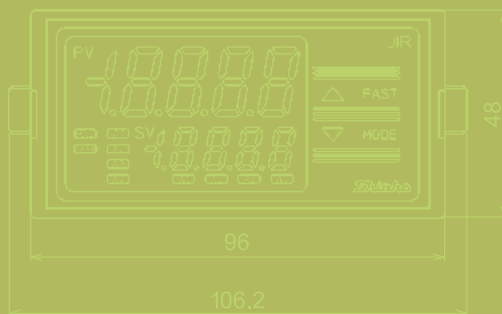

Multiple input and process measurement indication

4-points of alarm output (3-points standard, 1-point optional)



Standard transmission output (4 to 20mA DC)

Dust-proof/Drip-proof (IP66)

Features

Multi-input

Total 18 types of input can be chosen from thermocouple (10 types), RTD (2 types), Direct current (2 types) and DC voltage (4 types). For direct current input, a built-in 50 Ω shunt resistor or externally mounted 50 Ω shunt resistor can be selected.

Alarm Output (3 points) is Provided as Standard

Alarm output (3 points) is available as standard. Alarm type and status Energized/De-energized can be easily switched by keypad. (Factory default: No alarm action, Energized)

Standard Transmission Output

Converting the input value to analog signal every 125 ms, outputs the value in direct current. 4 to 20 mA DC output is a standard feature.

MODBUS

Serial communication (C5 option) protocol comprises Shinko protocol and MODBUS protocol. For MODBUS protocol, RTU mode or ASCII mode is selectable by keypad. This indicator can be connected to the MODBUS compatible instruments without using a communication converter.

Standard Dust-proof/Drip-proof (for front panel only)

IP66 structure means the indicator can be used even in harsh environment exposed to dust and water splashes.

Safety Standards

UL / C-UL, CE marking

Specifications

Model

JIR-301-M □ □ □ □	Series name: JIR-301-M (W96 x H48 x D100 mm)
Input M	Multi-range (*1)
Power supply voltage 1	100 to 240 V AC
	24 V AC/DC (*2)
Option	A4 Alarm 4 output (*3)
	C5 Serial communication (RS-485) (*4)
	P24 Insulated power output: 24 ± 3 V DC (*5), (*6)
	P5 Insulated power output: 5 ± 0.5 V DC (*5), (*6)
	DSB Power for 2-wire transmitter (Current loop supply) (*6), (*7)
	TA2(4-20) Direct current output 4 to 20 mA DC
	TA2(0-20) Direct current output 0 to 20 mA DC
	TV2(0-1) Transmission output 2 (*3) 0 to 1 V DC
	TV2(0-5) DC voltage output 0 to 5 V DC
	TV2(1-5) DC voltage output 1 to 5 V DC
	TV2(0-10) DC voltage output 0 to 10 V DC
	TA(0-20) Direct current output 0 to 20 mA DC
	TV(0-1) User specified 0 to 1 V DC
TV(0-5) Transmission output (*8) 0 to 5 V DC	
TV(1-5) DC voltage output 1 to 5 V DC	
TV(0-10) DC voltage output 0 to 10 V DC	
TC Terminal cover	

- Three alarm outputs (A1, A2, A3 output) are standard.
- Alarm types (4 types of A1, A2, and 5 types of A3 as well as No alarm action) and Energized/De-energized can be selected.
- (*1) Thermocouple (10 types), RTD (2 types), Direct current (2 types) and DC voltage (4 types) input can be selected by keypad.
- (*2) Power supply voltage 100 to 240 V AC is standard. When ordering 24 V AC/DC, enter '1' after the input code.
- (*3) Alarm 4 output (A4 option) and Transmission output 2 (T□2 option) cannot be used together.
- (*4) If Serial communication (RS-485) (C5 option) is ordered, the Event input function cannot be used.
- (*5) Insulated power output (P24 option) and Insulated power output (P5 option) cannot be used together. If Insulated power output (P24 or P5 option) is ordered, A2 output cannot be used.
- (*6) Insulated power output (P24 or P5 option) cannot be used with the Power for 2-wire transmitter (DSB option).
- (*7) If Power for 2-wire transmitter (DSB option) is ordered, only 4 to 20 mA DC input (Built-in 50 Ω shunt resistor) can be used.
- (*8) TA (4-20 mA DC) is a standard feature.

Rated Range

Input Type	Input Range
Thermocouple	K -200 to 1370 °C -320 to 2500 °F
	J -200.0 to 400.0 °C -200.0 to 750.0 °F
	R -200 to 1000 °C -320 to 1800 °F
	S 0 to 1760 °C 0 to 3200 °F
	T 0 to 1760 °C 0 to 3200 °F
	B 0 to 1820 °C 0 to 3300 °F
	E -200 to 800 °C -320 to 1500 °F
	N -200.0 to 400.0 °C -200.0 to 750.0 °F
	PL-II 0 to 1390 °C 0 to 2500 °F
	C (W/Re5-26) 0 to 2315 °C 0 to 4200 °F
RTD	Pt100 -200.0 to 850.0 °C -200.0 to 1000.0 °F
	JPt100 -200 to 850 °C -300 to 1500 °F
Direct current	4 to 20 mA DC (Externally mounted 50 Ω shunt resistor) -2000 to 10000 (*1), (*2)
	0 to 20 mA DC (Externally mounted 50 Ω shunt resistor) -2000 to 10000 (*1), (*2)
DC voltage	4 to 20 mA DC (Built-in 50 Ω shunt resistor) -2000 to 10000 (*1), (*3), (*4)
	0 to 20 mA DC (Built-in 50 Ω shunt resistor) -2000~10000(*1), (*3)
	0 to 1 V DC -2000 to 10000 (*1)
	0 to 5 V DC -2000 to 10000 (*1)
	1 to 5 V DC -2000 to 10000 (*1)
	0 to 10 V DC -2000 to 10000 (*1)

- (*1) Input range and decimal point place can be selected.
- (*2) Connect a 50 Ω shunt resistor (sold separately) between input terminals.
- (*3) This input type has a built-in 50 Ω shunt resistor.
- (*4) If Power for 2-wire transmitter (DSB option) is ordered, only 4 to 20 mA DC input (Built-in 50 Ω shunt resistor) can be used.

Name and Functions

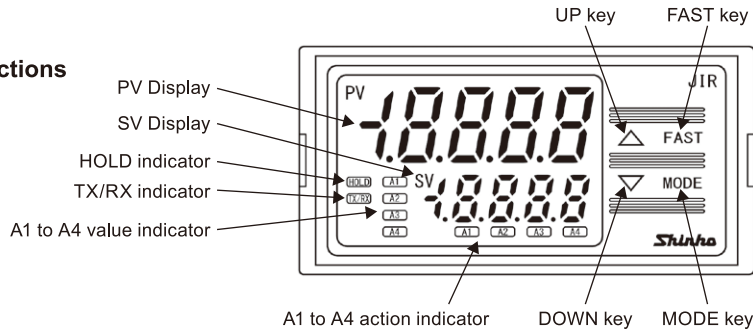

Display, Indicator

Name	Description
PV Display	Indicates PV (process variable) or characters in the setting mode with the red LED.
SV Display	Indicates A1/A2/A3/A4 value or the set value in the setting mode with the green LED.
HOLD indicator	When PV is held (HOLD, Peak HOLD, Bottom HOLD), the yellow LED is lit.
TX/RX indicator	The yellow LED is lit during Serial communication (C5 option) TX (transmitting) output.
A1 value indicator	When A1 value is indicated on the SV Display, the green LED is lit.
A2 value indicator	When A2 value is indicated on the SV Display, the green LED is lit.
A3 value indicator	When A3 value is indicated on the SV Display, the green LED is lit.
A4 value indicator	When A4 value is indicated on the SV Display, the green LED is lit. (A4 option)
A1 action indicator	When A1 output is ON, the red LED is lit. While A1 output is held (maintained), the red LED flashes.
A2 action indicator	When A2 output is ON, the red LED is lit. While A2 output is held (maintained), the red LED flashes.
A3 action indicator	When A3 output is ON, the red LED is lit. While A3 output is held (maintained), the red LED flashes.
A4 action indicator	When A4 output is ON, the red LED is lit. While A4 output is held (maintained), the red LED flashes. (A4 option)

Key

Name	Description
UP key	Increases the numeric value. If High/Low limit range alarm is selected in [A4 type], and if the SV Display indicates A4 value, the SV Display indicates A4 high limit value while the UP key is being pressed.
FAST key	Makes the set value change faster while pressing the UP/DOWN key and FAST key together.
DOWN key	Decreases the numeric value.
MODE key	Selects the setting mode, and registers the set value.

Standard Specifications

Display	PV: Red LED 5-digit, character size, 16 x 7.2 mm (H x W) SV: Green LED 5-digit, character size, 10 x 4.8 mm (H x W)								
Input	Thermocouple: K, J, R, S, B, E, T, N, PL-II, C (W/Re5-26) External resistance: 100 Ω max. (for B input, 40 Ω max.) RTD : Pt100, JPt100 3-wire type (Allowable input lead wire resistance: 10 Ω max. per wire) Direct current : 0 to 20 mA DC, 4 to 20 mA DC: Input impedance: 50 Ω Allowable input current: 50 mA DC max. DC voltage : 0 to 1 V DC: Input impedance: 1 MΩ min. Allowable input voltage: 5 V DC max. Allowable signal source resistance: 2 kΩ max. 0 to 5 V DC, 1 to 5 V DC, 0 to 10 V DC: Input impedance: 100 kΩ min. Allowable input voltage: 15 V DC max. Allowable signal source resistance: 100 Ω max.								
Accuracy (Setting, indication)	Thermocouple : Within ±0.2% of each input span ±1 digit, or within ±2°C (4°F), whichever is greater However, R, S input, 0 to 200°C (32 to 392°F): Within ±6°C (12°F) B input, 0 to 300°C (32 to 572°F): Accuracy is not guaranteed. K, J, E, T, N input, less than 0°C (32°F): Within ±0.4% of each input span ±1 digit RTD : Within ±0.1% of each input span ±1 digit, or within ±1°C (2°F), whichever is greater Direct current, voltage: Within ±0.2% of each input span ±1 digit								
Input sampling period	125 ms								
Event input function	3 types of the HOLD function and 2 types of Alarm HOLD can be selected. If Serial communication (C5 option) is ordered, the Event input function cannot be used.								
A1 output A2 output A3 output	Alarm type and status Energized/De-energized can be selected by keypad. • No alarm action • High limit alarm Setting range: Input range low limit value to input range high limit value • Low limit alarm Setting range: Input range low limit value to input range high limit value • High limit with standby alarm Setting range: Input range low limit value to input range high limit value • Low limit with standby alarm Setting range: Input range low limit value to input range high limit value • High/Low limit range alarm (*) Setting range: None When input has a decimal point, minimum negative value is -199.9, and maximum positive value is 999.9. Setting range for direct current or DC voltage input: Scaling low limit value to scaling high limit value. (*) Only A3 output can be selected. (High/Low limit range alarm is activated depending on A1 value and A2 value.) Setting accuracy: Same as indication accuracy Action : ON/OFF action Hysteresis : Thermocouple, RTD: 0.1 to 100.0°C (°F) Direct current, voltage: 1 to 1000 (The placement of the decimal point follows the selection.) Output : Relay contact 1a, 3 A 250 V AC (resistive load), Electrical life: 100,000 cycles								
Transmission output	Converting the input value to analog signal every 125 ms, outputs the value in direct current. Resolution : 12000 Direct current : 4 to 20 mA DC (Load resistance: Max. 550 Ω) Output accuracy: Within ±0.3% of transmission output span Response time : 400 ms+ Input sampling period (0%→90%)								
Power supply voltage	100 to 240 V AC 50/60 Hz, 24 V AC/DC 50/60 Hz Allowable voltage fluctuation range: 85 to 264 V AC, 20 to 28 V AC/DC								
Power consumption	<table border="1"> <thead> <tr> <th>Supply Voltage</th> <th>Power Consumption</th> </tr> </thead> <tbody> <tr> <td>100 to 240 V AC</td> <td>Approx. 8 VA (When maximum options are ordered: Approx.10 VA)</td> </tr> <tr> <td>24 V AC</td> <td>Approx. 6 VA (When maximum options are ordered: Approx.9 VA)</td> </tr> <tr> <td>24 V DC</td> <td>Approx. 4 W (When maximum options are ordered: Approx.7 W)</td> </tr> </tbody> </table>	Supply Voltage	Power Consumption	100 to 240 V AC	Approx. 8 VA (When maximum options are ordered: Approx.10 VA)	24 V AC	Approx. 6 VA (When maximum options are ordered: Approx.9 VA)	24 V DC	Approx. 4 W (When maximum options are ordered: Approx.7 W)
Supply Voltage	Power Consumption								
100 to 240 V AC	Approx. 8 VA (When maximum options are ordered: Approx.10 VA)								
24 V AC	Approx. 6 VA (When maximum options are ordered: Approx.9 VA)								
24 V DC	Approx. 4 W (When maximum options are ordered: Approx.7 W)								
Insulation resistance	10 MΩ or more, at 500 V DC								
Dielectric strength	Between Input terminal - Ground terminal, Input terminal - Power terminal -----1.5 kV AC for 1 minute Between Power terminal - Ground terminal -----1.5 kV AC for 1 minute Between Output terminal - Ground terminal, Output terminal - Power terminal ---- 1.5 kV AC for 1 minute (Output terminal comprises A1, A2, A3, A4 output, Transmission output 1, Transmission output 2 and communication terminals.)								
Environment	Ambient temperature: 0 to 50°C (32 to 122°F) Ambient humidity: 35 to 85 %RH (Non-condensing)								
Safety standards	UL: Power input rating 100-240 V AC, 24 V AC/DC File No. E159038								
Environmental spec	RoHS directive compliant								
Case (material, color)	Material: Flame-resistant resin Color: Black								
Mounting	Screw type mounting brackets (Mountable panel thickness: 1 to 8 mm)								
Setting method	Sheet key input								
Dimensions, Weight	Dimensions: W96 x H48 x D100 mm Weight: Approx. 300 g								
Attached function	Sensor correction coefficient, Sensor correction, Set value lock, Power failure countermeasure, Self-diagnosis, Automatic cold junction temperature compensation (only thermocouple), Sensor burnout alarm, Input error indication, Warm-up indication, Drip-proof/Dust-proof IP66								
Altitude	2,000m or less								

Optional Specifications When ordering, designate an option code.

Alarm 4 output (A4 option)	This option and Transmission output 2 (T□ 2 option) cannot be used together. Alarm type, alarm action and alarm output are the same as those of A1, A2 and A3 output except High/Low limit range alarm.												
User specified transmission output (TA, TV option)	Converting the input value to analog signal every 125 ms, outputs the value in direct current or voltage. If this option is ordered, the standard transmission output (4 to 20 mA) will be invalid. Resolution: 12000 <table border="1"> <thead> <tr> <th>Option Code</th> <th>Transmission Output Type</th> </tr> </thead> <tbody> <tr> <td>TA(0-20)</td> <td>Direct current 0 to 20 mA DC (Load resistance: Max 550 Ω)</td> </tr> <tr> <td>TV(0-1)</td> <td>0 to 1 V DC (Load resistance: Minimum 100 kΩ)</td> </tr> <tr> <td>TV(0-5)</td> <td>0 to 5 V DC (Load resistance: Minimum 500 kΩ)</td> </tr> <tr> <td>TV(1-5)</td> <td>1 to 5 V DC (Load resistance: Minimum 500 kΩ)</td> </tr> <tr> <td>TV(0-10)</td> <td>0 to 10 V DC (Load resistance: Minimum 1 MΩ)</td> </tr> </tbody> </table> Output accuracy: Within ±0.3% of transmission output span	Option Code	Transmission Output Type	TA(0-20)	Direct current 0 to 20 mA DC (Load resistance: Max 550 Ω)	TV(0-1)	0 to 1 V DC (Load resistance: Minimum 100 kΩ)	TV(0-5)	0 to 5 V DC (Load resistance: Minimum 500 kΩ)	TV(1-5)	1 to 5 V DC (Load resistance: Minimum 500 kΩ)	TV(0-10)	0 to 10 V DC (Load resistance: Minimum 1 MΩ)
Option Code	Transmission Output Type												
TA(0-20)	Direct current 0 to 20 mA DC (Load resistance: Max 550 Ω)												
TV(0-1)	0 to 1 V DC (Load resistance: Minimum 100 kΩ)												
TV(0-5)	0 to 5 V DC (Load resistance: Minimum 500 kΩ)												
TV(1-5)	1 to 5 V DC (Load resistance: Minimum 500 kΩ)												
TV(0-10)	0 to 10 V DC (Load resistance: Minimum 1 MΩ)												
Serial communication (C5 option)	The following operations can be carried out from an external computer. • Reading and setting of various set values • Reading of PV and action status • Function change If this option is ordered, the Event input function cannot be used. Communication line : EIA RS-485 Communication method : Half-duplex communication Synchronization method : Start-stop synchronization Communication speed : 2400/4800/9600/19200/38400 bps (Selectable by keypad) Parity : Even/Odd/No parity (Selectable by keypad) Stop bit : 1, 2 (Selectable by keypad) Communication protocol : Shinko protocol/MODBUS RTU/MODBUS ASCII (Selectable by keypad) In addition, each protocol above is available with Block read. Connectable number of unit : Max. 31 units per host computer Communication error detection: Double detection by parity and checksum												
Insulated power output (P24 option)	24 V DC, which is used as the power source for 2-wire transmitter, is output from terminals 9 and 10. If this option is ordered, A2 output cannot be used. This option cannot be used together with the Insulated power output (P5 option) or with Power for 2-wire transmitter (DSB option). Output voltage : 24 ±3 V DC (When load current is 30 mA) Ripple voltage : Within 200 mV DC (When load current is 30 mA) Max. load current: 30 mA DC												
Insulated power output (P5 option)	If this option is ordered, A2 output cannot be used. This option cannot be used together with the Insulated power output (P24 option) or with Power for 2-wire transmitter (DSB option). Output voltage : 5 ±0.5 V DC (When load current is 30 mA) Ripple voltage : Within 200 mV DC (When load current is 30 mA) Max. load current: 30 mA DC												

Power for 2-wire transmitter (DSB option)	If this option is ordered, only 4 to 20 mA DC input (Built-in 50 Ω shunt resistor) can be used. This option cannot be used together with the Insulated power output (P24 or P5 option). Output voltage: 24 ±3 V DC (When load current is 30 mA) Ripple voltage: Within 200 mV DC (When load current is 30 mA) Max. load current: 30 mA DC														
Transmission output 2 (T□2 option)	This option cannot be used together with Alarm 4 output (A4 option). <table border="1"> <thead> <tr> <th>Option Code</th> <th>Transmission Output Type</th> </tr> </thead> <tbody> <tr> <td>TA2(4-20)</td> <td>Direct current</td> </tr> <tr> <td>TA2(0-20)</td> <td>DC voltage</td> </tr> <tr> <td>TV2(0-1)</td> <td>DC voltage</td> </tr> <tr> <td>TV2(0-5)</td> <td>DC voltage</td> </tr> <tr> <td>TV2(1-5)</td> <td>DC voltage</td> </tr> <tr> <td>TV2(0-10)</td> <td>DC voltage</td> </tr> </tbody> </table>	Option Code	Transmission Output Type	TA2(4-20)	Direct current	TA2(0-20)	DC voltage	TV2(0-1)	DC voltage	TV2(0-5)	DC voltage	TV2(1-5)	DC voltage	TV2(0-10)	DC voltage
Option Code	Transmission Output Type														
TA2(4-20)	Direct current														
TA2(0-20)	DC voltage														
TV2(0-1)	DC voltage														
TV2(0-5)	DC voltage														
TV2(1-5)	DC voltage														
TV2(0-10)	DC voltage														
Terminal cover (TC option)	Electrical shock protection terminal cover (Be sure to use this terminal cover by ordering this option if operator may touch the back of the indicator while running the indicator.)														

Terminal Arrangement

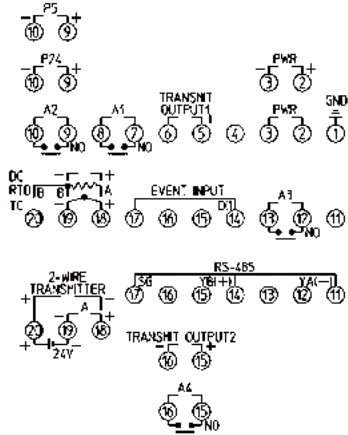

GND	Ground terminal
PWR	Power supply voltage
TRANSMIT OUTPUT1	Transmission output 1
A1	A1 output
A2	A2 output
A3	A3 output
EVENT INPUT	Event input
TC	Thermocouple input
RTD	RTD input
DC	Direct current input, DC voltage input For direct current input (externally mounted 50 Ω shunt resistor), connect a 50 Ω shunt resistor (sold separately) between input terminals.
P24	Insulated power output 24 V (P24 option)
P5	Insulated power output 5 V (P5 option)
RS-485	Serial communication (RS-485) (C5 option)
TRANSMIT OUTPUT2	Transmission output 2 (T□2 option)
A4	A4 output (A4 option)
A	Direct current input (DSB option)
24V	Power for 2-wire transmitter (DSB option)

External Dimensions (Scale: mm)

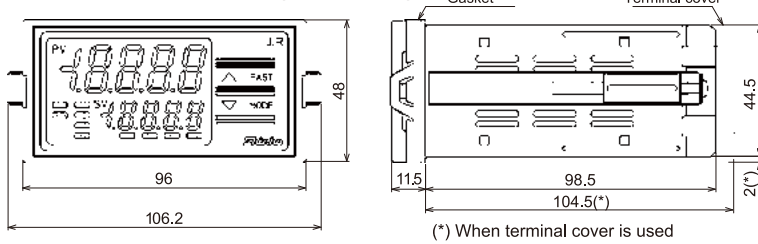

Panel Cutout (Scale: mm)

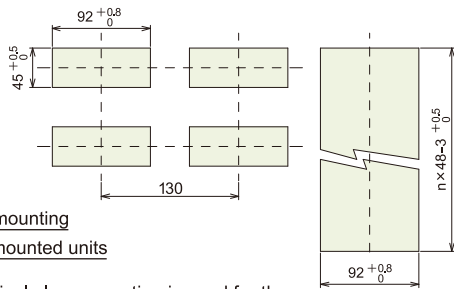

Caution: If vertical close mounting is used for the instrument, IP66 (Dust-proof/Drip-proof) may be compromised, and all warranties will be invalidated.

Wiring Example

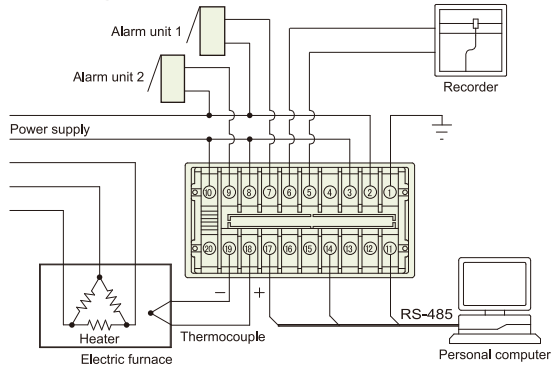

Solderless Terminal

Use a solderless terminal with an insulation sleeve in which an M3 screw fits as shown below. 0.63 N·m of torque is recommended.

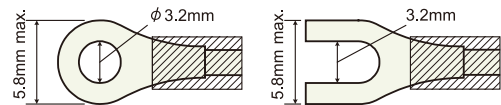

- Caution**
- The terminal block of this instrument is designed to be wired from the upper side.
 - If Insulated power output (P24 or P5 option) is ordered, A2 output cannot be used.
 - If Serial communication (C5 option) is ordered, the Event input function cannot be used.



- To ensure safe and correct use, thoroughly read and understand the manual before using this instrument.
- This instrument is intended to be used for industrial machinery, machine tools and measuring equipment. Verify correct usage after purpose-of-use consultation with our agency or main office. (Never use this instrument for medical purposes with which human lives are involved.)
- External protection devices such as protective equipment against excessive temperature rise, etc. must be installed, as malfunction of this product could result in serious damage to the system or injury to personnel. Proper periodic maintenance is also required.
- This instrument must be used under the conditions and environment described in the manual. Shinko Technos Co., Ltd. does not accept liability for any injury, loss of life or damage occurring due to the instrument being used under conditions not otherwise stated in the manual.

Caution with respect to Export Trade Control ordinance

To avoid this instrument from being used as a component in, or as being utilized in the manufacture of weapons of mass destruction (i.e. military applications, military equipment, etc.), please investigate the end users and the final use of this instrument. In the case of resale, ensure that this instrument is not illegally exported.

- This catalog is as of July 2024 and its contents are subject to change without notice.
- Photos used in this catalog do not show unit in operating status.
- If you have any inquiries, please consult us or our agency.

SHINKO TECHNOS CO., LTD. OVERSEAS DIVISION

Head Office : 2-5-1, Senbahigashi, Minoo, Osaka, 562-0035, Japan
 Tel : +81-72-727-6100
 Fax : +81-72-727-7006
 URL : <https://shinko-technos.co.jp/e/>
 E-mail : overseas@shinko-technos.co.jp