

PROGRAMMABLE CONTROLLER

PCB1

INSTRUCTION MANUAL

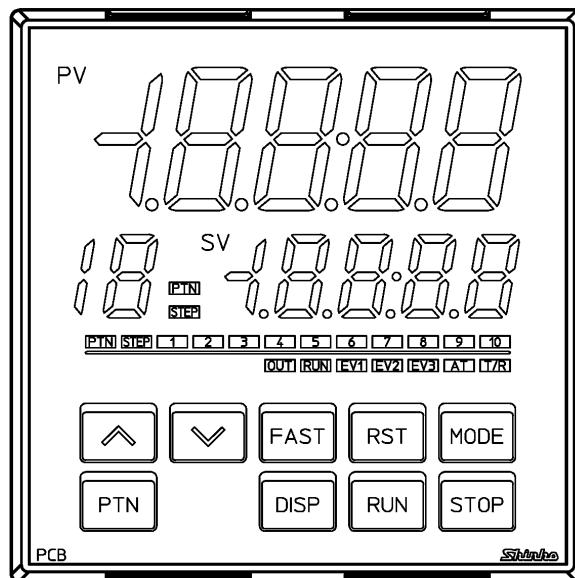

Shinbo

Preface

Thank you for purchasing our programmable controller PCB1. This manual contains instructions for the mounting, functions, operations and notes when operating the PCB1. To prevent accidents arising from the misuse of this controller, please ensure the operator receives this manual.

Abbreviations used in this manual

Abbreviation	Term
PV	Process variable
SV	Desired value
MV	Output manipulated variable
OUT1	Control output OUT1
OUT2	Control output OUT2
AT	Auto-tuning

Characters used in this manual (□: No character is indicated)

Indication	1	0	1	2	3	4	5	6	7	8	9	C	F
Number, °C/°F	-1	0	1	2	3	4	5	6	7	8	9	°C	°F
Indication	A	b	c	d	E	F	G	H	I	J	k	L	m
Alphabet	A	B	C	D	E	F	G	H	I	J	K	L	M
Indication	n	o	P	q	r	S	T	U	V	W	X	Y	Z
Alphabet	N	O	P	Q	R	S	T	U	V	W	X	Y	Z

Notes

- This instrument should be used in accordance with the specifications described in the manual. If it is not used according to the specifications, it may malfunction or cause a fire.
- Be sure to follow the warnings, cautions and notices. If they are not observed, serious injury or malfunction may occur.
- The contents of this instruction manual are subject to change without notice.
- Care has been taken to ensure that the contents of this instruction manual are correct, but if there are any doubts, mistakes or questions, please inform our sales department.
- This instrument is designed to be installed through the control panel. If it is not, measures must be taken to ensure that the operator cannot touch power terminals or other high voltage sections.
- Any unauthorized transfer or copying of this document, in part or in whole, is prohibited.
- Shinko Technos Co., Ltd. is not liable for any damage or secondary damage(s) incurred as a result of using this product, including any indirect damage.

Safety Precautions (Be sure to read these precautions before using our products.)

The safety precautions are classified into categories: "Warning" and "Caution". Depending on circumstances, procedures indicated by ⚠ Caution may result in serious consequences, so be sure to follow the directions for usage.

⚠ Warning Procedures which may lead to dangerous conditions and cause death or serious injury, if not carried out properly.

⚠ Caution Procedures which may lead to dangerous conditions and cause superficial to medium injury or physical damage or may degrade or damage the product, if not carried out properly.

⚠ Warning

- To prevent an electrical shock or fire, only Shinko or other qualified service personnel may handle the inner assembly.
- To prevent an electrical shock, fire or damage to the instrument, parts replacement may only be undertaken by Shinko or other qualified service personnel.

⚠ Safety Precautions

- To ensure safe and correct use, thoroughly read and understand this manual before using this instrument.
- This instrument is intended to be used for industrial machinery, machine tools and measuring equipment. Verify correct usage after purpose-of-use consultation with our agency or main office. (Never use this instrument for medical purposes with which human lives are involved.)
- External protection devices such as protective equipment against excessive temperature rise, etc. must be installed, as malfunction of this product could result in serious damage to the system or injury to personnel. Proper periodic maintenance is also required.
- This instrument must be used under the conditions and environment described in this manual. Shinko Technos Co., Ltd. does not accept liability for any injury, loss of life or damage occurring due to the instrument being used under conditions not otherwise stated in this manual.

⚠ Caution with Respect to Export Trade Control Ordinance

To avoid this instrument from being used as a component in, or as being utilized in the manufacture of weapons of mass destruction (i.e. military applications, military equipment, etc.), please investigate the end users and the final use of this instrument. In the case of resale, ensure that this instrument is not illegally exported.

1. Installation Precautions

⚠ Caution

This instrument is intended to be used under the following environmental conditions (IEC61010-1): Overvoltage category II, Pollution degree 2

Ensure the mounting location corresponds to the following conditions:

- A minimum of dust, and an absence of corrosive gases
- No flammable, explosive gases
- No mechanical vibrations or shocks
- No exposure to direct sunlight, an ambient temperature of -10 to 55°C (14 to 131°F) that does not change rapidly, and no icing
- An ambient non-condensing humidity of 35 to 85%RH
- No large capacity electromagnetic switches or cables through which large current is flowing
- No water, oil or chemicals or where the vapors of these substances can come into direct contact with the unit
- Please note that the ambient temperature of this unit – not the ambient temperature of the control panel – must not exceed 55°C (131°F) if mounted through the face of a control panel, otherwise the life of the electronic components (especially electrolytic capacitors) may be shortened.

Note: Avoid setting this instrument directly on or near flammable material even though the case of this instrument is made of flame-resistant resin.

2. Wiring Precautions



Caution

- Do not leave wire remnants in the instrument, as they could cause a fire or malfunction.
- Use the solderless terminal with an insulation sleeve in which the M3 screw fits when wiring the instrument.
- The terminal block of this instrument is designed to be wired from the left side. The lead wire must be inserted from the left side of the terminal, and fastened with the terminal screw.
- Tighten the terminal screw using the specified torque. If excessive force is applied to the screw when tightening, the terminal screw or case may be damaged.
- Do not pull or bend the lead wire on the terminal side when wiring or after wiring, as it could cause malfunction.
- This instrument does not have a built-in power switch, circuit breaker and fuse. It is necessary to install a power switch, circuit breaker and fuse near the controller.
(Recommended fuse: Time-lag fuse, rated voltage 250 V AC, rated current 2 A)
- For a 24 V AC/DC power source, do not confuse polarity when using direct current (DC).
- Do not apply a commercial power source to the sensor which is connected to the input terminal nor allow the power source to come into contact with the sensor.
- Use a thermocouple and compensating lead wire according to the sensor input specifications of this controller.
- Use the 3-wire RTD according to the sensor input specifications of this controller.
- For DC voltage input, (+) side input terminal number of 0 to 5 V DC, 1 to 5 V DC, 0 to 10 V DC differs from that of 0 to 1 V DC.

Terminal Number	DC Voltage Input
②①	(+) side of 0 to 5 V DC, 1 to 5 V DC, 0 to 10 V DC
②②	(+) side of 0 to 1 V DC

- When using a relay contact output type, externally use a relay according to the capacity of the load to protect the built-in relay contact.
- When wiring, keep input wires (thermocouple, RTD, etc.) away from the AC power sources or load wires.

3. Operation and Maintenance Precautions



Caution

- It is recommended that AT be performed on the trial run.
- Do not touch live terminals. This may cause electrical shock or problems in operation.
- Turn the power supply to the instrument OFF before retightening the terminal or cleaning.
Working on or touching the terminal with the power switched ON may result in severe injury or death due to electrical shock.
- Use a soft, dry cloth when cleaning the instrument.
(Alcohol based substances may tarnish or deface the unit.)
- As the display section is vulnerable, be careful not to put pressure on, scratch or strike it with a hard object.

Contents

1. Model.....	7
1.1 Model	7
1.2 How to Read the Model Label	8
2. Name and Functions of Controller	9
3. Mounting to the Control Panel.....	12
3.1 External Dimensions (Scale: mm)	12
3.2 Panel Cutout (Scale: mm).....	12
3.3 CT (Current Transformer) External Dimensions (Scale: mm).....	13
3.4 Mounting to, and Removal from, the Control Panel	14
3.4.1 How to Mount the Unit.....	14
3.4.2 How to Remove the Mounting Bracket and Unit.....	15
4. Wiring	16
4.1 Terminal Arrangement.....	17
4.2 Lead Wire Solderless Terminal	18
4.3 When Using a Terminal Cover	18
4.4 Wiring	19
4.4.1 Power Supply	19
4.4.2 Control Output OUT1 and OUT2	19
4.4.3 Input.....	20
4.4.4 Event Output EV1, EV2 and EV3.....	20
4.4.5 Insulated Power Output.....	20
4.4.6 Serial Communication	21
4.4.7 CT Input 1 and CT Input 2	23
4.4.8 Transmission Output	24
4.4.9 Event Input DI1 and DI2	24
5. Outline of Key Operation and Each Mode	26
5.1 Outline of Key Operation	26
5.2 Registering Settings and Selections.....	28
5.3 How to Read Setting Items	28
6. Initial Settings	29
7. Basic Settings and Operation	38
7.1 Procedure of Basic Settings and Operation	38
7.2 Program Pattern Setting	39
8. Explanation of Setting Items	44
8.1 Setting Items in Pattern Setting Mode.....	44
8.2 Setting Items in Event Setting Mode	49
8.3 Setting Items in Control Parameter Setting Mode.....	55
8.4 Setting Items in Wait Parameter Setting Mode.....	65
8.5 Setting Items in Engineering Setting Mode 1	69
8.6 Setting Items in Engineering Setting Mode 2	73
8.7 Clearing Data.....	90
9. Operation	91
9.1 Performing Program Control.....	91
9.1.1 Performing Program Control.....	91
9.1.2 Stopping Program Control.....	96

9.1.3	Suspending Program Control (Program Control HOLD Function)	97
9.1.4	Advancing Program Step (Advance Function)	98
9.1.5	Speeding up Program Step Time (Step Time Speed-up Function)	98
9.1.6	Changing Program Step SV and Step Time	99
9.1.7	Ending Program (Pattern End Function)	99
9.2	Performing Fixed Value Control	100
9.2.1	Performing Fixed Value Control	100
9.2.2	Finishing Fixed Value Control	102
9.3	Switching Indication of the SV Display	103
9.4	Performing AT	104
9.4.1	Notice when Performing AT	104
9.4.2	AT Action	105
9.4.3	Performing AT	106
9.5	Input Value Correction	107
9.6	Items to be Initialized by Changing Settings	109
10.	Action Explanation	110
10.1	OUT1 Action	110
10.2	OUT1 ON/OFF Control Action	110
10.3	Heater Burnout Alarm Action	111
10.4	Alarm Action	112
10.5	OUT2 (Heating/Cooling Control) Action	114
10.6	OUT2 (Heating/Cooling Control) Action (When Setting Dead Band)	115
10.7	OUT2 (Heating/Cooling control) Action (When Setting Overlap band)	116
11.	Specifications	117
11.1	Standard Specifications	117
11.2	Optional Specifications	131
12.	Troubleshooting	134
12.1	Indication	134
12.2	Key Operation	136
12.3	Control	137
13.	Character Table	138
13.1	Error Code	138
13.2	Pattern Setting Mode	139
13.3	Event Setting Mode	143
13.4	Control Parameter Setting Mode	145
13.5	Wait Parameter Setting Mode	148
13.6	Engineering Setting Mode 1	150
13.7	Engineering Setting Mode 2	152
13.8	Data Clear	159
14.	Making Program Pattern Table and Data Table	160
14.1	Making Program Pattern Table	160
14.2	Making Data Table	161
15.	Key Operation Flowchart	164

1. Model

1.1 Model

PCB1	<input type="checkbox"/>	<input type="checkbox"/>	0-	<input type="checkbox"/>	<input type="checkbox"/>	
Control output OUT1	R					Relay contact output
	S					Non-contact voltage output
	A					Direct current output
Power supply voltage	0					100 to 240 V AC
	1					24 V AC/DC
Input		0				Multi-range
Option 1	0					Option 1 not needed.
	1				EV2(DR) (*1)	Event output EV2, or Heating/Cooling control output OUT2 Relay contact output
	2				DS	Heating/Cooling control output OUT2 Non-contact voltage output
	3				DA	Heating/Cooling control output OUT2 Direct current output
	4				P24	Insulated power output
	5				EV3(DR) (*1), (*2)	Event output EV3 + Event output EV2, or Heating/Cooling control output OUT2 Relay contact output
	6				EV3DS (*2)	Event output EV3 + Heating/Cooling control output OUT2 Non-contact voltage output
	7				EV3DA (*2)	Event output EV3 + Heating/Cooling control output OUT2 Direct current output
Option 2	0					Option 2 not needed.
	1				C5W(20A) (*3)	Serial communication + Heater burnout alarm output + Event input (*4)
	2				C5W(100A) (*3)	Serial communication + Heater burnout alarm output + Event input (*4)
	3				EIW(20A) (*3)	Event input + Heater burnout alarm output
	4				EIW(100A) (*3)	Event input + Heater burnout alarm output
	5				EIT (*2)	Event input + Transmission output (4 – 20 mA DC)
	6				C5	Serial communication RS-485 + Event input (*4)
	7				W(20A) (*3)	Heater burnout alarm output
	8				W(100A) (*3)	Heater burnout alarm output
	9				EI	Event input + Event output EV3

(*1) When 'Heating/Cooling control Relay contact output' is selected in [Event output EV2 allocation], it works as the DR option.

(*2) The EV3D□ option and EIT option cannot be ordered together.

(*3) When control output OUT1 is Relay contact output or Non-contact voltage output, the C5W, EIW or W option can be ordered.

(*4) 'SV digital transmission' or 'SV digital reception' can be selected in [Communication protocol].

1.2 How to Read the Model Label

The model label is attached to the right side of the case.

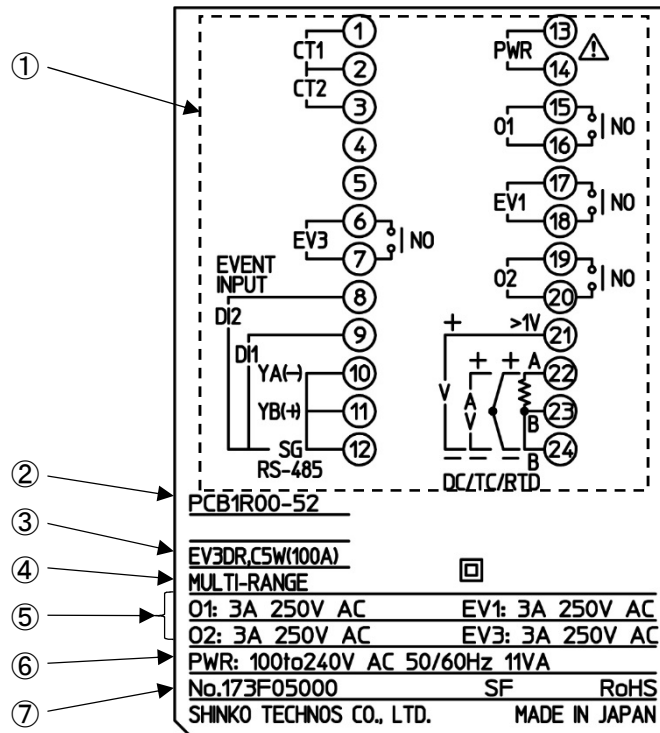

(Fig. 1.2-1)

No.	Description	Example
①	Terminal arrangement	Terminal arrangement of PCB1R00-52 (*1)
②	Model	PCB1R00-52
③	Option	EV3DR (Event output EV3 + Event output EV2, or Heating/Cooling control output OUT2 Relay contact output) C5W(100A) [Serial communication + Heater burnout alarm output (100 A) + Event input] (*2)
④	Input	MULTI-RANGE (Multi-range input)
⑤	Control output, Event output	O1: 3 A 250 V AC (Control output OUT1) EV1: 3 A 250 V AC (Event output EV1) O2: 3 A 250 V AC (Control output OUT2) EV3: 3 A 250 V AC (Event output EV3)
⑥	Power supply, Power consumption	100 to 240 V AC 50/60 Hz, 11 VA
⑦	Serial number	No. 173F05000

(*1) Terminal arrangement diagram differs depending on the model.

(*2) For Heater burnout alarm output (C5W, EIW, W options), CT rated current is entered in bracket ().

2. Name and Functions of Controller

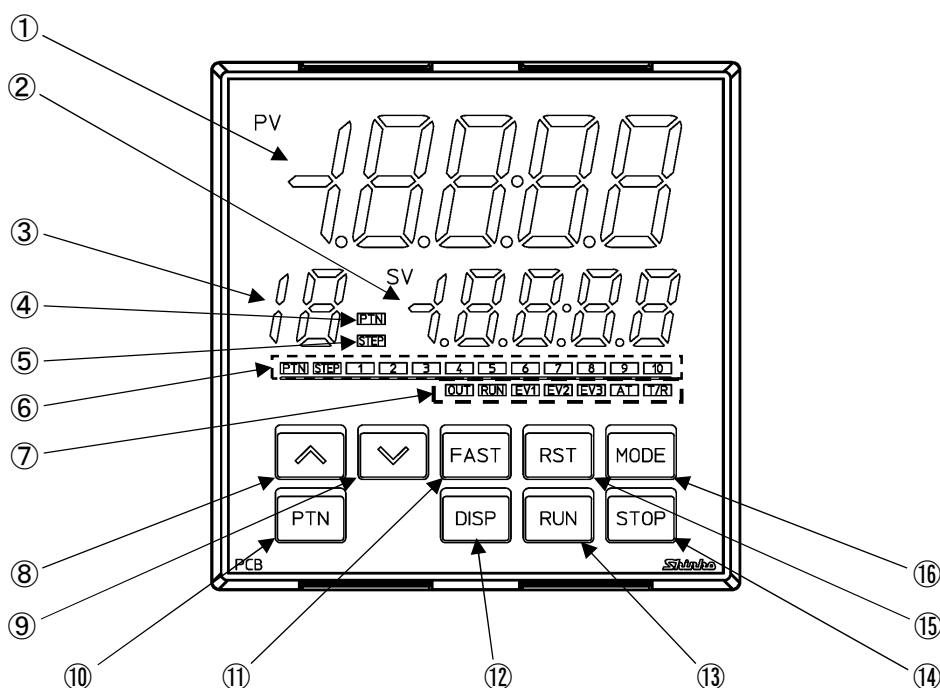

(Fig. 2-1)

Display, Indicator

No.	Name	Description
①	PV Display (Red)	Indicates process variable (PV) in RUN mode. Indicates setting characters in Setting mode. Flashes during Wait action or program control HOLD in program control.
②	SV Display (Green)	Indicates the desired value (SV), Output manipulated variable (MV), or Remaining time (TIME) in RUN mode. Retains display indication at power OFF. Indicates the set values in setting mode.
③	PTN/STEP Display (Orange)	Indicates the pattern number or step number. Each time the [DISP] key is pressed, the PTN/STEP Display (③), and the PTN/STEP indicator (⑥) alternately indicate the pattern number and step number. Flashes during Wait action or when the step number is indicated. If 'SV digital reception' is selected in [Communication protocol], \overline{r} is indicated.
④	PTN indicator (Orange)	Lights up when the pattern number is indicated on the PTN/STEP Display.
⑤	STEP indicator (Orange)	Lights up when the step number is indicated on the PTN/STEP Display.
⑥	PTN/STEP indicator (Green)	LED for the pattern number or step number lights up. If the PTN/STEP Display (③) indicates the pattern number, the PTN/STEP indicator (⑥) lights up its step number. If the PTN/STEP Display indicates the step number, the PTN/STEP indicator lights up its pattern number. Each time the [DISP] key is pressed, the PTN/STEP indicator and the PTN/STEP Display alternately indicate the pattern number and step number.

Action Indicator

No.	Name	Description
⑦	OUT (Green)	Lights up when control output OUT1 is ON. For direct current output, flashes corresponding to the MV in 125 ms cycles.
	RUN (Orange)	Lights up during program control RUN. Flashes during program control HOLD or Fixed value control.
	EV1 (Red)	Lights up when Event output EV1 is ON.
	EV2 (Red)	Lights up when Event output EV2 [(EV2, EV3(DR) options] is ON. Lights up when control output OUT2 [Cooling output (EV2, DS, DA or EV3D□ option)] is ON. For direct current output (DA, EV3DA options), flashes corresponding to the MV in 125 ms cycles.
	EV3 (Red)	Lights up when Event output EV3 (EV3D□, EI options) is ON.
	AT (Orange)	Flashes while AT is performing.
	T/R (Orange)	Lights up during serial communication (C5W, C5 options) TX (transmitting) output.

Key

No.	Name	Description
⑧	UP key	In setting mode, increases the numerical value. By pressing for approx. 1 second during program control RUN, time progress pauses, and Fixed value control continues with the step SV at that time (program control HOLD function).
⑨	DOWN key	In setting mode, decreases the numerical value.
⑩	PTN key (Pattern key)	During program control STOP (in Standby), selects program pattern number to perform or to set. By pressing during program control RUN, moves to Monitor mode. In Monitor mode, switches the indication items.
⑪	FAST key	In setting mode, makes the numeric value change faster. During program control RUN, makes step time progress 60 times faster.
⑫	DISP key (Display key)	During RUN mode, the PTN/STEP display and PTN/STEP indicator alternately indicates the pattern number and step number. In setting mode, registers the setting data, and moves back to the previous setting item.
⑬	RUN key	Performs program control, or cancels program control HOLD while program control is held. By pressing for approx. 1 second during program control RUN, stops performing step, and proceeds to the next step (Advance function).
⑭	STOP key	Stops program control by pressing for approx. 1 second during program control RUN. Cancels pattern end output.
⑮	RST key (Reset key)	In setting mode, registers the setting data, and moves to RUN mode.
⑯	MODE key	In setting mode, registers the setting data, and moves to the next setting item.

Tool cable
CMD-001

Top view of the case

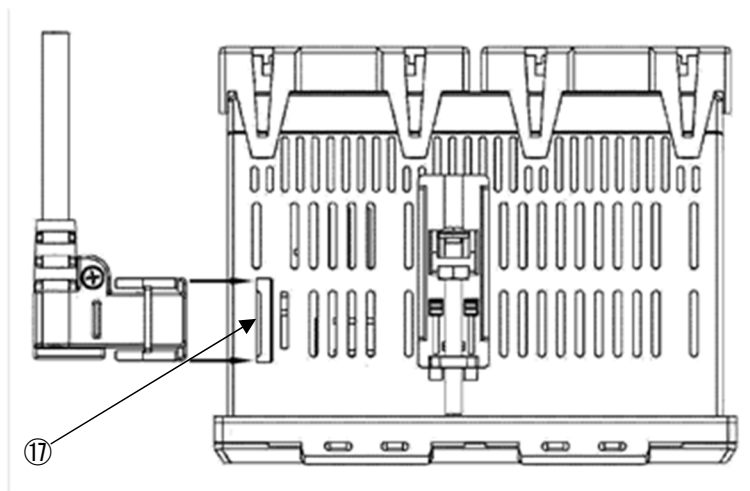

(Fig. 2-2)

Connector

No.	Name	Description
⑰	Tool cable connector	<p>By connecting the Tool cable (CMD-001, sold separately), the following operations can be conducted from an external computer, using the Monitoring software SWM-PCB101M.</p> <p>Tool cable connector is at the top of the instrument.</p> <ul style="list-style-type: none"> • Reading and writing of step SV, step time, PID and various set values • Reading of PV and action status • Function change

3. Mounting to the Control Panel

3.1 External Dimensions (Scale: mm)

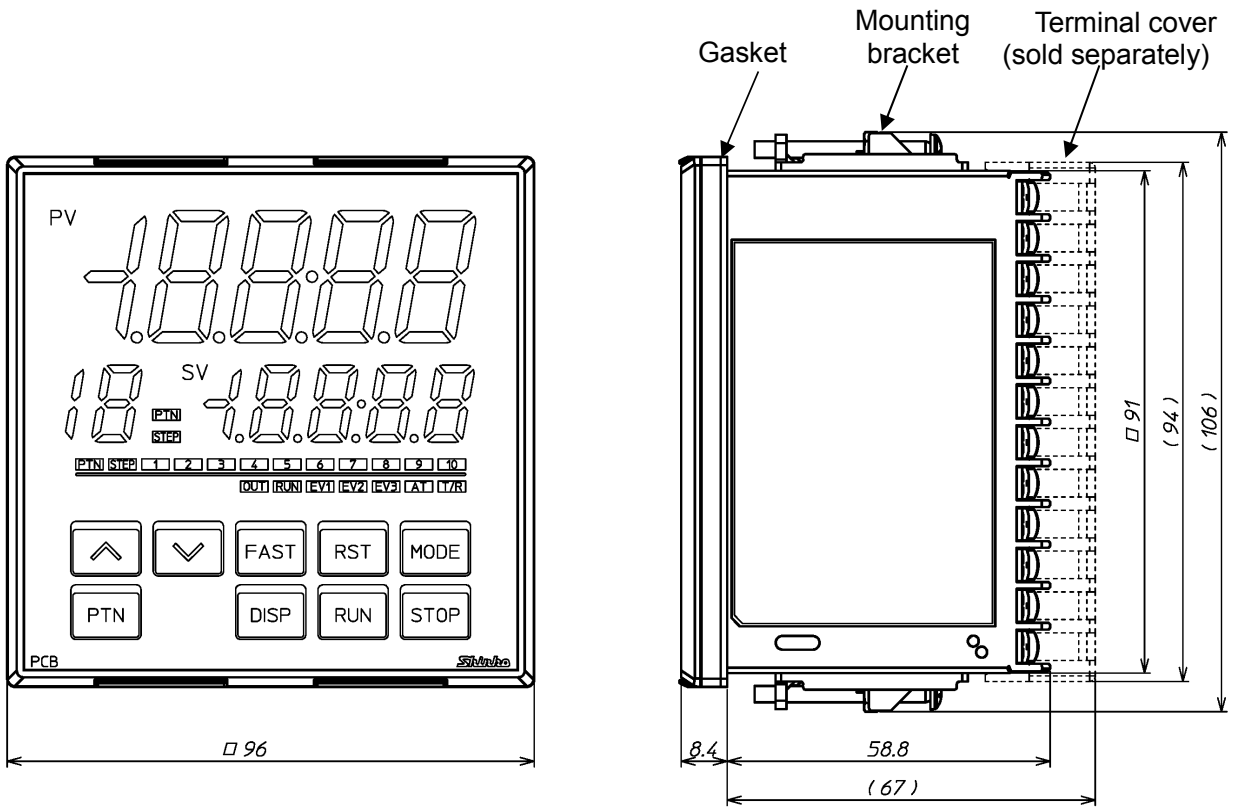

(): Size when mounting brackets or terminal cover (sold separately) are mounted.

(Fig. 3.1-1)

3.2 Panel Cutout (Scale: mm)

⚠ Caution

If horizontal close mounting is used for the controller, IP66 specification (Drip-proof/Dust-proof) may be compromised, and all warranties will be invalidated.

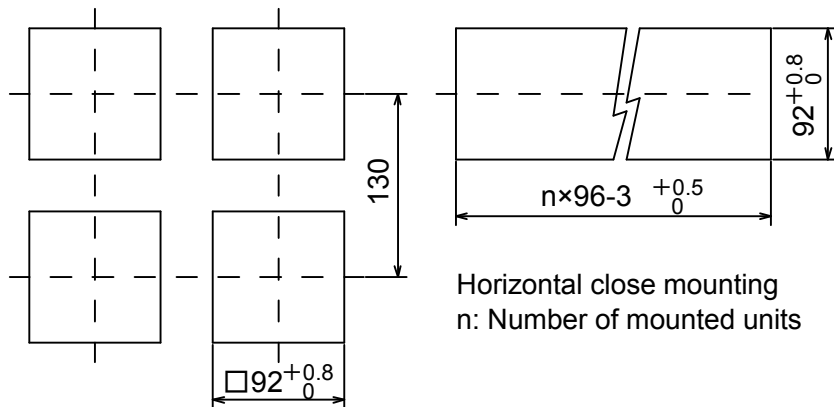

(Fig. 3.2-1)

3.3 CT (Current Transformer) External Dimensions (Scale: mm)

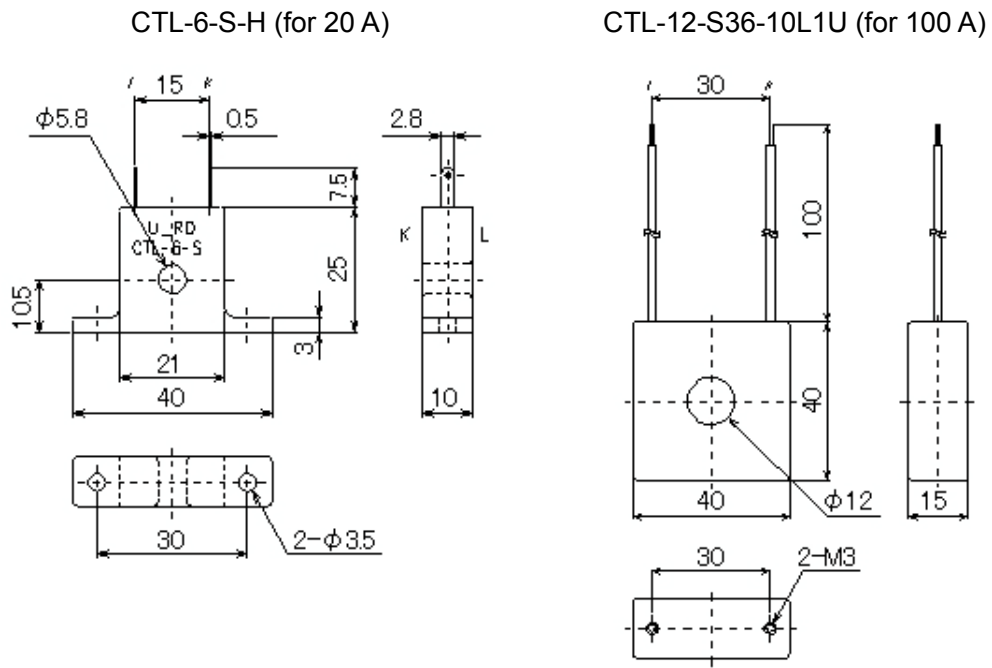

(Fig. 3.3-1)

3.4 Mounting to, and Removal from, the Control Panel



Caution

As the case of the PCB1 is made of resin, do not use excessive force while tightening screws, or the case and mounting brackets could be damaged.

The torque should be 0.1 N·m.

3.4.1 How to Mount the Unit

Mount the controller vertically to the flat, rigid panel to ensure it adheres to the Drip-proof/Dust-proof specification (IP66).

If the horizontal close mounting is used for the controller, IP66 specification (Drip-proof/Dust-proof) may be compromised, and all warranties will be invalidated.

Mountable panel thickness: 1 to 7 mm

(1) Insert the controller from the front side of the control panel. (Fig. 3.4.1-1)

If the Drip-proof/Dust-proof specification (IP66) is not necessary, the gasket may be removed.

(Please keep in mind the warranty is void if gasket is removed).

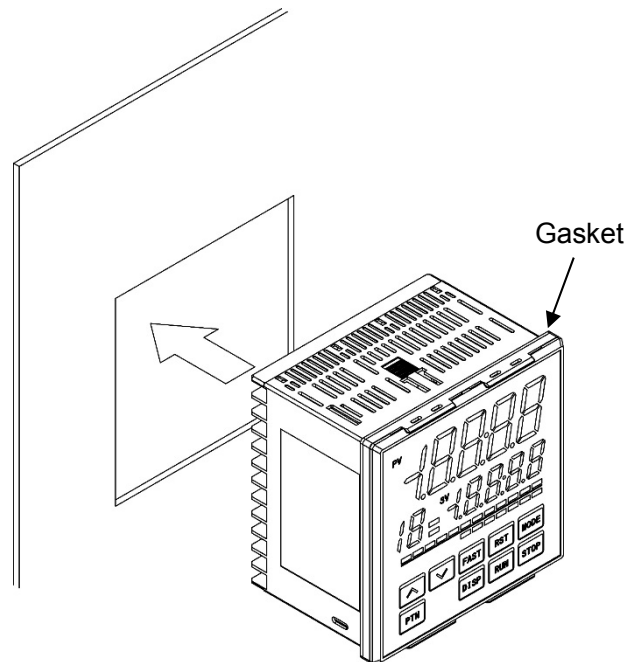

(Fig. 3.4.1-1)

- (2) Attach the mounting brackets into the slots at the top and bottom of the case, and secure the controller in place with the screws. (Fig. 3.4.1-2)

The torque is 0.1 N•m.

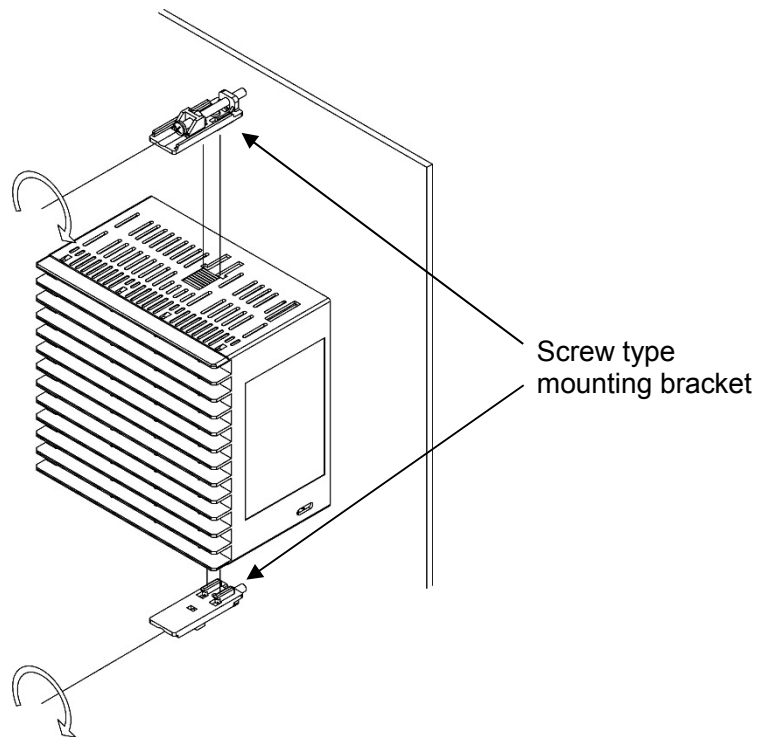

(Fig. 3.4.1-2)

3.4.2 How to Remove the Mounting Bracket and Unit

- (1) Turn the power to the unit OFF, and disconnect all wires before removing the unit.
- (2) Loosen the screws of the mounting brackets, and remove the mounting brackets.
- (3) Pull the unit out from the front of the control panel.

4. Wiring



Warning

Turn the power supply to the instrument off before wiring or checking.

Working on or touching the terminal with the power switched on may result in severe injury or death due to electrical shock.



Caution

- Do not leave wire remnants in the instrument, as they could cause a fire or malfunction.
- Use the solderless terminal with an insulation sleeve in which the M3 screw fits when wiring the instrument.
- The terminal block of this instrument is designed to be wired from the left side. The lead wire must be inserted from the left side of the terminal, and fastened with the terminal screw.
- Tighten the terminal screw using the specified torque. If excessive force is applied to the screw when tightening, the terminal screw or case may be damaged.
- Do not pull or bend the lead wire on the terminal side when wiring or after wiring, as it could cause malfunction.
- This instrument does not have a built-in power switch, circuit breaker and fuse. It is necessary to install a power switch, circuit breaker and fuse near the controller.
(Recommended fuse: Time-lag fuse, rated voltage 250 V AC, rated current 2 A)
- For a 24 V AC/DC power source, do not confuse polarity when using direct current (DC).
- Do not apply a commercial power source to the sensor which is connected to the input terminal nor allow the power source to come into contact with the sensor.
- Use a thermocouple and compensating lead wire according to the sensor input specifications of this controller.
- Use the 3-wire RTD according to the sensor input specifications of this controller.
- For DC voltage input, (+) side input terminal number of 0 to 5 V DC, 1 to 5 V DC, 0 to 10 V DC differs from that of 0 to 1 V DC.

Terminal Number	DC Voltage Input
②1	(+) side of 0 to 5 V DC, 1 to 5 V DC, 0 to 10 V DC
②2	(+) side of 0 to 1 V DC

- When using a relay contact output type, externally use a relay according to the capacity of the load to protect the built-in relay contact.
- When wiring, keep input wires (thermocouple, RTD, etc.) away from the AC power sources or load wires.

4.1 Terminal Arrangement

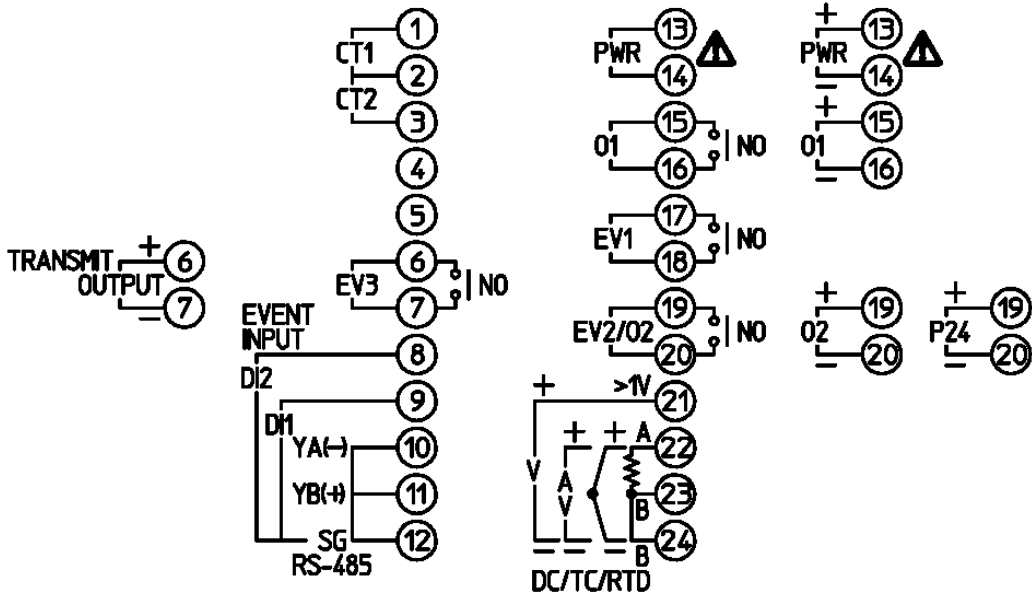

(Fig. 4.1-1)

Terminal Code	Description
PWR	Supply voltage 100 to 240 V AC or 24 V AC/DC (For 24 V DC, ensure polarity is correct.)
O1	Control output OUT1
EV1	Event output EV1
EV2	Event output EV2 [EV2, EV3(DR) options]
O2	Control output OUT2 (EV2, DS, DA, EV3D□ options)
P24	Insulated power output 24 V DC (P24 option)
TC	Thermocouple input
RTD	RTD input
DC	Direct current, DC voltage input
CT1	CT (current transformer) input 1 (C5W, EIW, W options)
CT2	CT (current transformer) input 2 (C5W, EIW, W options)
RS-485	Serial communication RS-485 (C5W, C5 options)
EVENT INPUT	Event input DI1 (C5W, EIW, EIT, C5, EI options) Event input DI2 (C5W, EIW, EIT, C5, EI options)
EV3	Event output EV3 (EV3D□, EI options)
TRANSMIT OUTPUT	Transmission output (EIT option)

4.2 Lead Wire Solderless Terminal

Use a solderless terminal with an insulation sleeve in which an M3 screw fits as shown below. The torque should be 0.63 N·m.

Solderless Terminal	Manufacturer	Model	Tightening Torque
Y-type	Nichifu Terminal Industries Co., Ltd.	TMEV1.25Y-3	0.63 N·m
	Japan Solderless Terminal MFG Co., Ltd.	VD1.25-B3A	
Ring-type	Nichifu Terminal Industries Co., Ltd.	TMEV1.25-3	
	Japan Solderless Terminal MFG Co., Ltd.	V1.25-3	

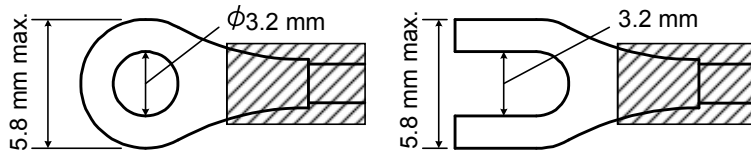

(Fig. 4.2-1)

4.3 When Using a Terminal Cover

When using a terminal cover (sold separately), make sure the longer side is on the back left and right side of the case.

Pass the wires from terminal numbers 13 to 24 between terminal covers.

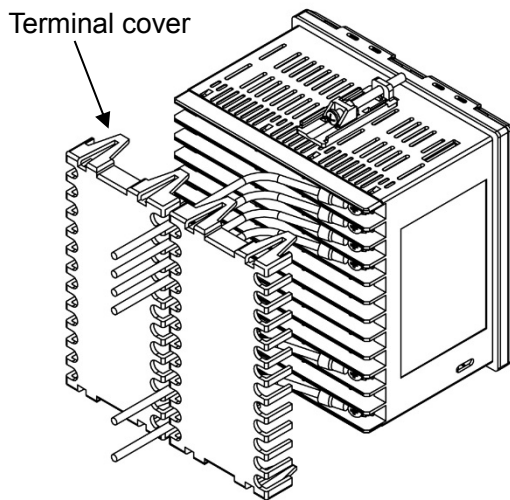

(Fig. 4.3-1)

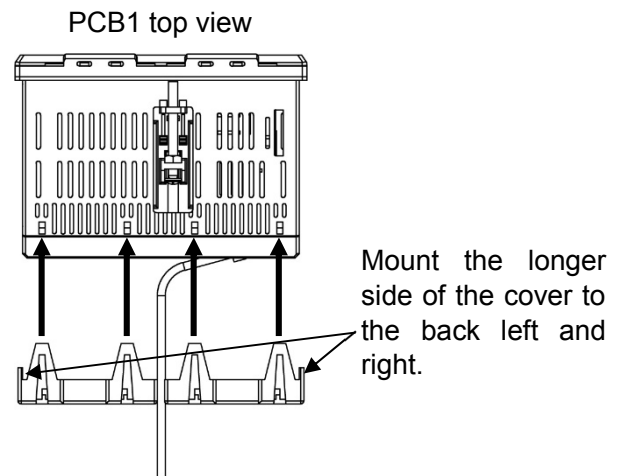

(Fig. 4.3-2)

4.4 Wiring

For the terminal arrangement, refer to Section '4.1 Terminal Arrangement' (p.17).

4.4.1 Power Supply

Power supply voltage is 100 to 240 V AC or 24 V AC/DC.

For a 24 V AC/DC power source, ensure polarity is correct when using direct current (DC).

100 to 240 V AC, 24 V AC	24 V DC

4.4.2 Control Output OUT1 and OUT2

When EV2, DS, DA or EV3D□ option is ordered, control output OUT2 is available.

Specifications of Control output OUT1 and OUT2 are shown below.

Relay contact	1a Control capacity: 3 A 250 V AC (resistive load), 1 A 250 V AC (inductive load $\cos\phi=0.4$) Electrical life: 100,000 cycles Minimum applicable load: 10 mA 5 V DC
Non-contact voltage (for SSR drive)	12 V DC $\pm 15\%$ Max. 40 mA (short circuit protected)
Direct current	4 to 20 mA DC Load resistance: Max. 550 Ω

Relay contact	Non-contact voltage, Direct current

Number of Shinko SSR units when connected in parallel (for Non-contact voltage output):

- SA-400 series: 5 units
- SA-500 series: 2 units

4.4.3 Input

Each input wiring is shown below.

Note: For DC voltage input, (+) side input terminal number of 0 to 5 V DC, 1 to 5 V DC, 0 to 10 V DC differs from that of 0 to 1 V DC.

Thermocouple	RTD	Direct current, DC voltage (0 to 1 V)	DC voltage (0 to 5 V, 1 to 5 V, 0 to 10 V)

4.4.4 Event Output EV1, EV2 and EV3

Event output EV1 is a standard feature.

Event output EV2 is available when EV2 or EV3(DR) option is ordered.

Event output EV3 is available when EV3D□ or EI option is ordered.

Specifications of Event output EV1, EV2 and EV3 are shown below.

Relay contact	1a Control capacity: 3 A 250 V AC (resistive load) 1 A 250 V AC (inductive load $\cos\phi=0.4$) Electrical life: 100,000 cycles Minimum applicable load: 10 mA 5 V DC
----------------------	--

Event Output EV1	Event Output EV2	Event Output EV3

4.4.5 Insulated Power Output

If P24 option is ordered, the Insulated power output is available.

Specifications of Insulated power output are shown below.

Output voltage	24 ± 3 V DC (When load current is 30 mA DC)
Ripple voltage	Within 200 mV DC (When load current is 30 mA DC)
Max. load current	30 mA DC

Insulated Power Output

4.4.6 Serial Communication

If the C5W or C5 option is ordered, Serial communication is available.

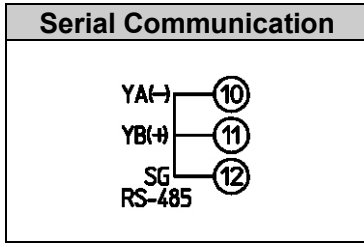

(1) Serial Communication

- When using USB communication cable CMC-001-1 (sold separately)

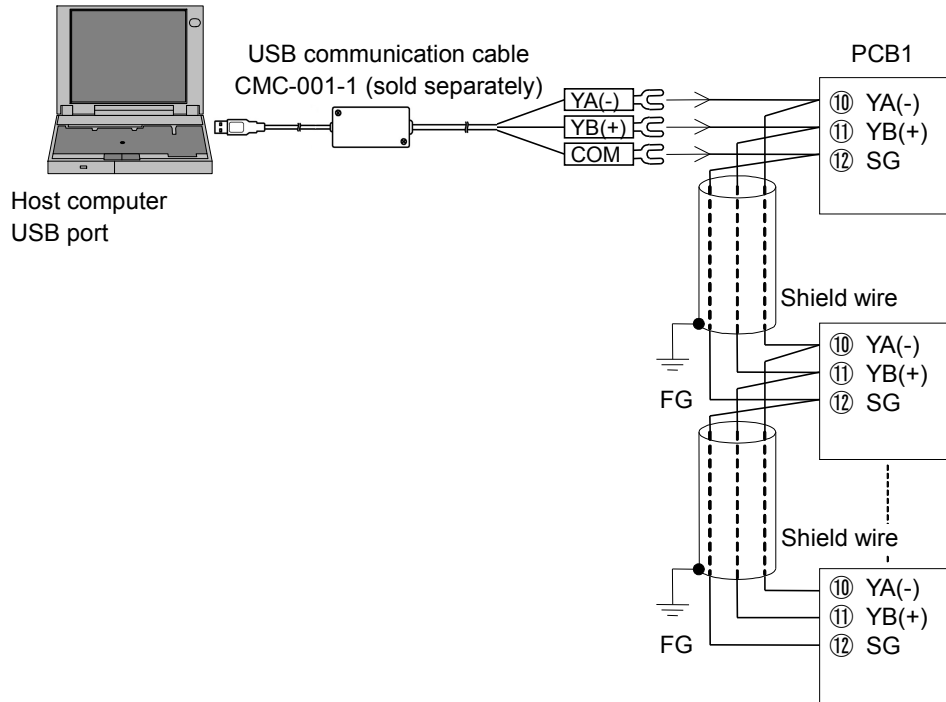

(Fig. 4.4.6-1)

- When using communication converter IF-400 (sold separately)

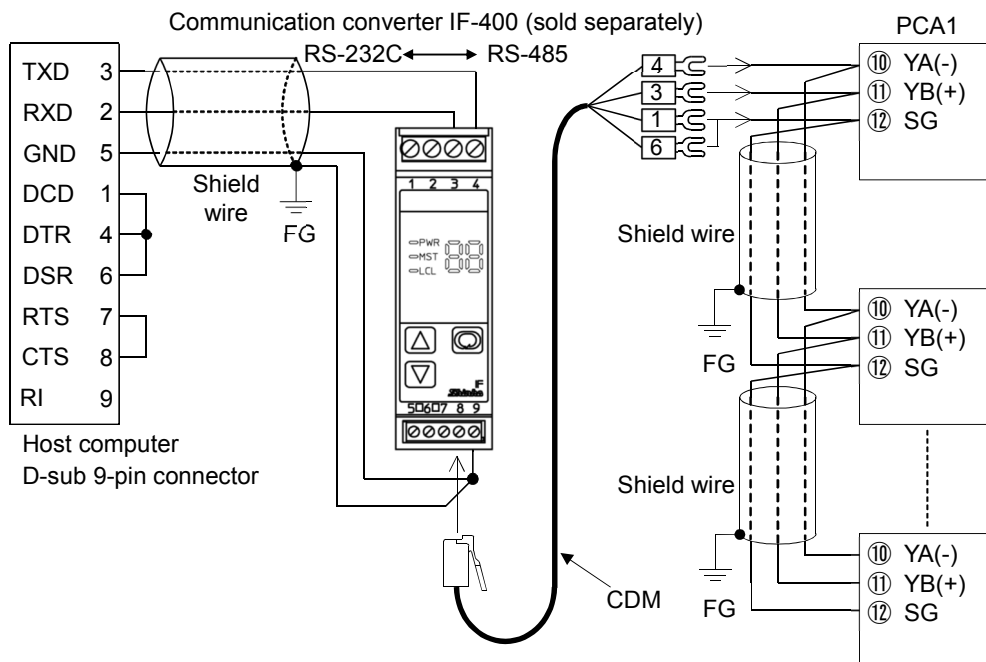

(Fig. 4.4.6-2)

(2) SV digital transmission

If 'SV digital transmission' is selected in [Communication protocol]:

Step SV can be digitally transmitted to the connected Shinko indicating controllers with the C5 (Serial communication) option.

If 'SV digital reception' is selected in [Communication protocol]:

Receives digital SV via SVTC command from the connected Shinko programmable controllers.

Shinko programmable controllers:

PC-900, PCD-33A: When the SVTC (SV digital transmission) option is ordered

PCA1, PCB1: When 'SV digital transmission' is selected in [Communication protocol]

Update cycle: 250 ms

Wiring

For the PCB1 and controllers with the communication function, connect YA (-) to YA (-), YB (+) to YB (+), SG to SG terminal respectively.

Up to 31 units can be connected.

Wiring example of PCB1 and controllers with communication function

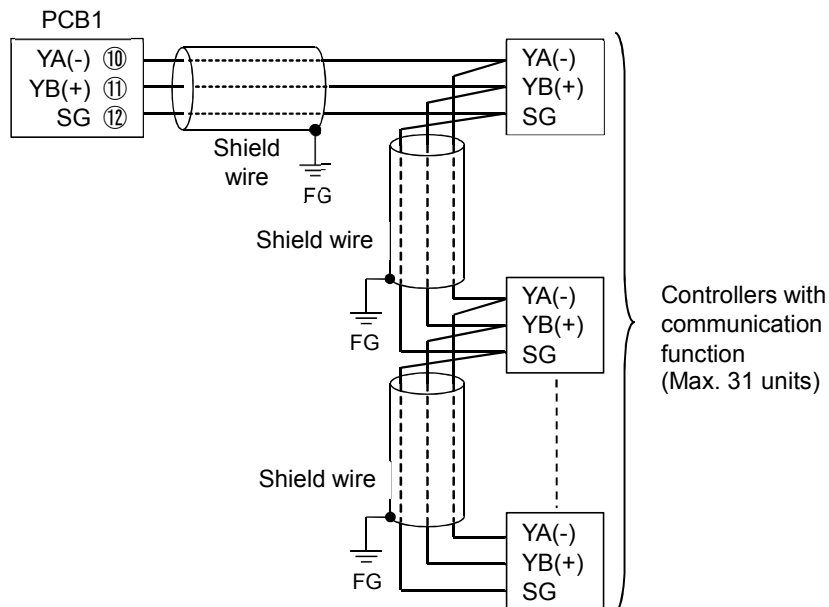

(Fig. 4.4.6-3)

Shield wire

Connect only one end of the shield to the FG terminal to avoid a ground loop. If both ends of the shield wire are connected to the FG terminal, the circuit will be closed, resulting in a ground loop. This may cause noise.

Be sure to ground the FG terminal.

Recommended cable: OTSC-VB 2PX0.5SQ (made by Onamba Co., Ltd.) or equivalent (Use a twisted pair cable.)

4.4.7 CT Input 1 and CT Input 2

Current Transformer (CT) input is available when Heater burnout alarm output (C5W, EIW, W options) is ordered.

Cannot be used for detecting heater current under phase control.

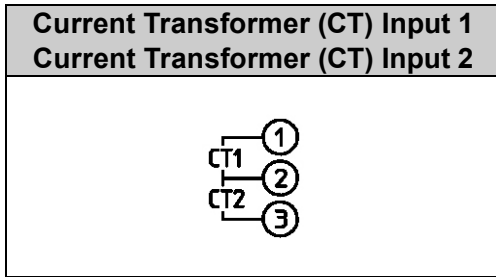

Use the CT (current transformer) provided, and pass one lead wire of the heater circuit into the hole of the CT. (Fig. 4.4.7-1)

When wiring, keep the CT wire away from AC sources or load wires to avoid the external interference.

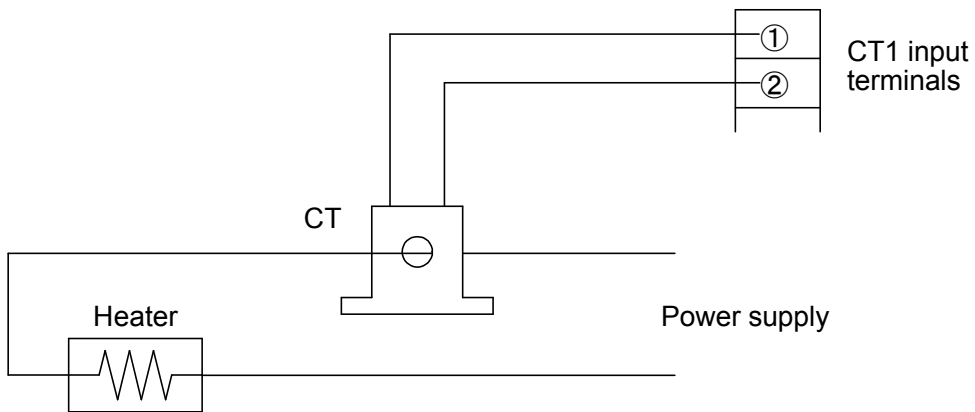

(Fig. 4.4.7-1)

When using 3-phase, pass any 2 lead wires of R, S, T into the CT, and connect them to CT1 (①-②) and CT2 (②-③) terminals. (Fig. 4.4.7-2)

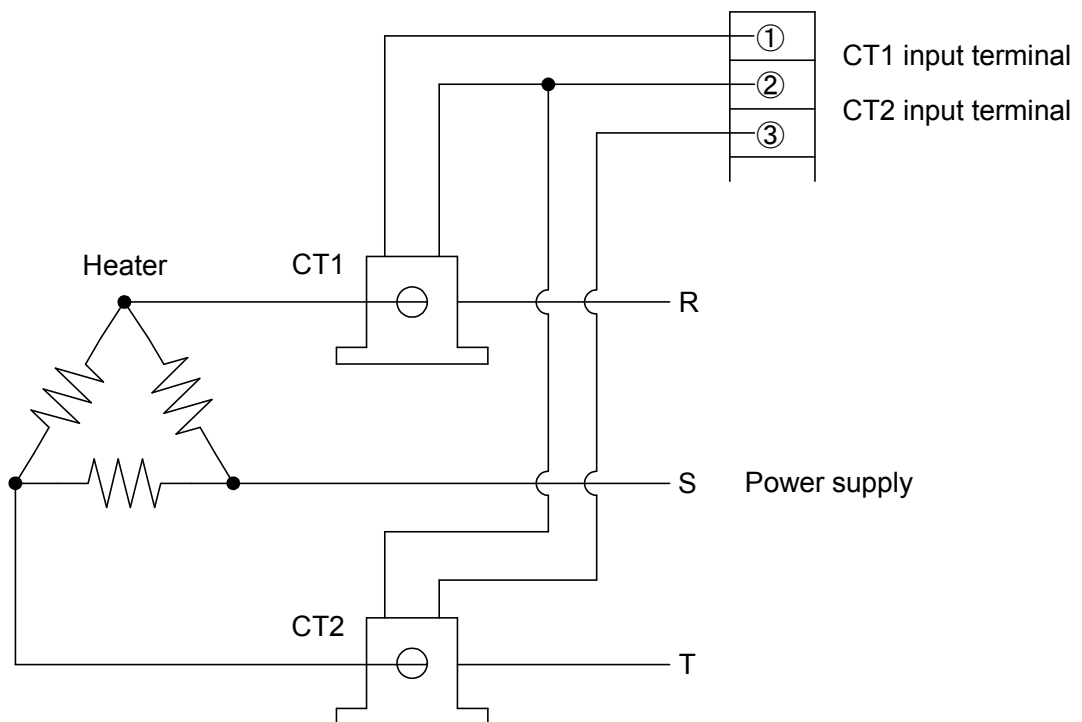

(Fig. 4.4.7-2)

4.4.8 Transmission Output

If the EIT option is ordered, Transmission output is available.

Specifications of Transmission output are shown below.

Resolution	12000
Output	4 to 20 mA DC Load resistance: Max. 550 Ω
Output accuracy	Within ±0.3% of Transmission output span
Response time	400 ms + Input sampling period (0%→90%)

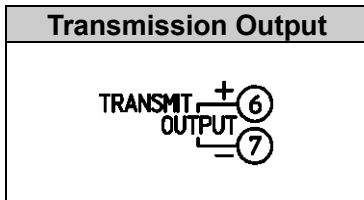

Converting the value (PV, SV or MV transmission) to analog signal every 125 ms, outputs the value in current. (Factory default: PV transmission)

Outputs Transmission output low limit value if Transmission output high limit and low limit value are the same.

If SV or MV transmission is selected, 4 mA is output while in program control STOP (in Standby).

4.4.9 Event Input DI1 and DI2

When C5W, EIW, EIT, C5 or EI option is ordered, Event input DI1 or Event input DI2 is available.

Specifications of Event input are shown below.

Circuit current when closed	Approx. 16 mA
------------------------------------	---------------

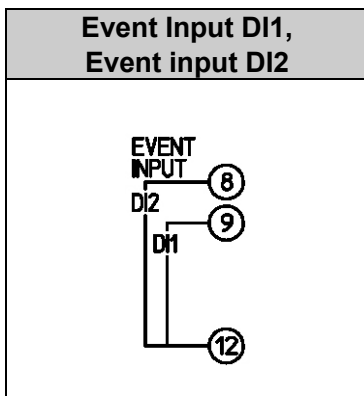

Signal edge action from OFF to ON / ON to OFF is engaged. However, when the power is turned ON, level action is used except Program control Advance function.

If any function except 'Pattern number selection' is selected in [Event input DI1/DI2 allocation], OR calculation [if any one is ON (Closed), the function activates] begins.

An action changed by Event input DI□ has priority.

If 'Pattern number selection' is selected in [Event input DI1/DI2 allocation], Patterns 2 to 4 can be selected by ON (Closed) or OFF (Open) status of Event input DI1 and DI2.

Pattern numbers selected by Event input have priority over pattern numbers selected by keypad operation.

To select pattern numbers by keypad, make sure all Event inputs are in OFF (Open) status.

- When 'Pattern number selection' is selected only for Event input DI1:

Pattern number	*	2
Event input DI1	OFF (Open)	ON (Closed)

* This number will be selected by keypad operation.

- When 'Pattern number selection' is selected for both Event input DI1 and DI2:

Pattern number	*	2	3	4
Event input DI1	OFF (Open)	ON (Closed)	OFF (Open)	ON (Closed)
Event input DI2	OFF (Open)	OFF (Open)	ON (Closed)	ON (Closed)

* This number will be selected by keypad operation.

5. Outline of Key Operation and Each Mode

5.1 Outline of Key Operation

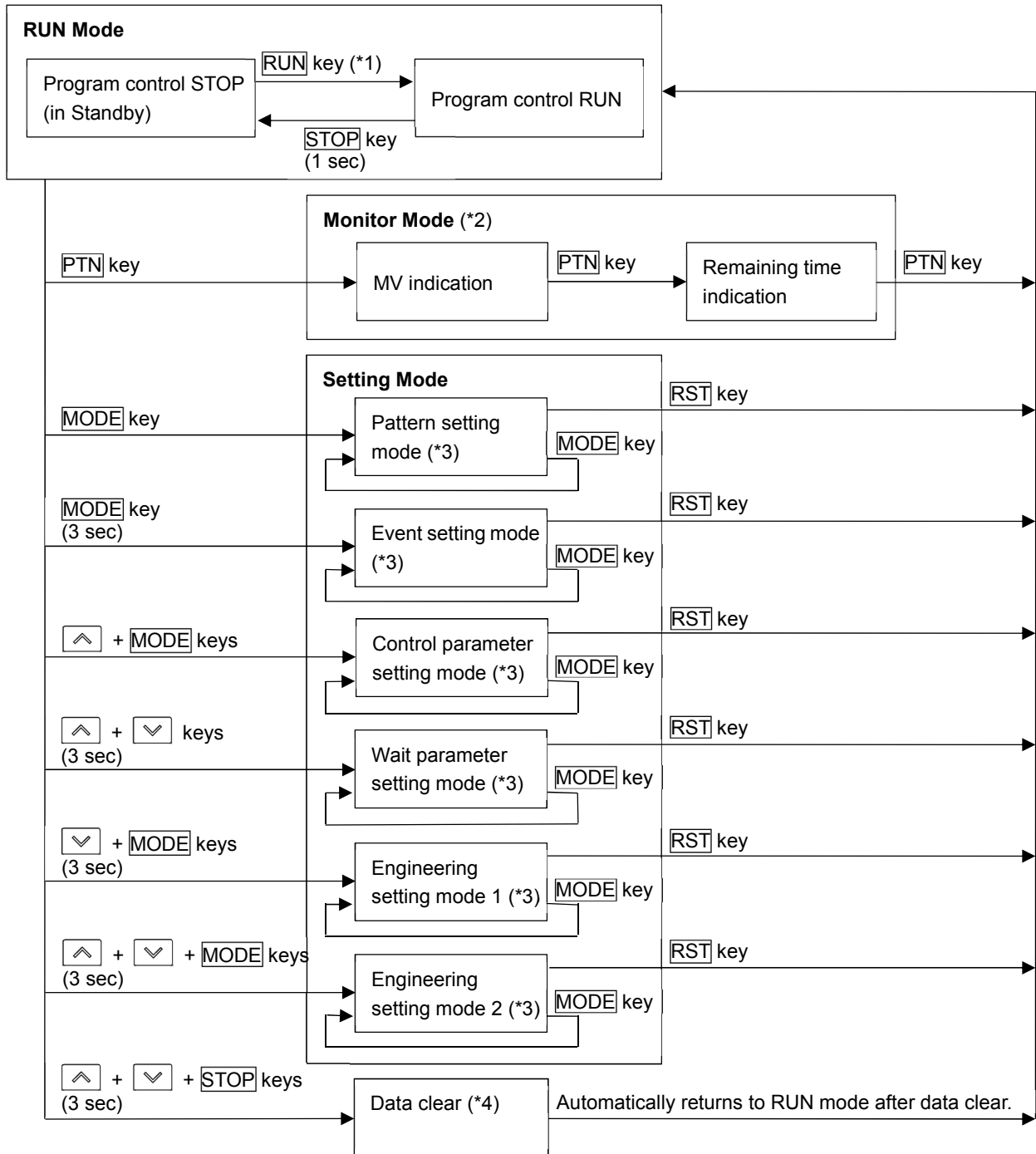

- (*1) Select a pattern number with the **PTN** key, and press the **RUN** key. Program control will start.
- (*2) Effective during Program control RUN.
- (*3) If the **MODE** key is pressed, settings or selections are registered, and moves to the next setting item.
 If the **MODE** key is pressed at the last setting item in each setting mode, the unit returns to the 1st setting item.
 If the **DISP** key is pressed, settings or selections are registered, and moves back to the previous setting item.
 If the **DISP** key is pressed at the 1st setting item in each setting mode, the unit moves back to the last setting item.
- (*4) Effective during program control STOP (in Standby).



(Fig. 5.1-1)



Modes



Mode	Description	
RUN mode	<p>If power is turned ON, the unit enters RUN mode. Starts from program control STOP (in Standby) or Program control RUN, depending on the status at power OFF. Indication differs depending on the status below.</p>	
	<p>Program control STOP (in Standby)</p>	<p>The PV Display indicates PV. When the PTN indicator and STEP of the PTN/STEP indicator is lit, the PTN/STEP Display indicates the pattern number. While the PTN of the PTN/STEP indicator is lit, the PTN indicator, the STEP indicator and the PTN/STEP Display are unlit. Other Displays and indicators are unlit.</p>
	<p>Program control RUN</p>	<p>The PV Display indicates PV. The SV Display indicates SV, MV or remaining time. The PTN indicator or STEP indicator lights up. While the PTN indicator is lit, the PTN/STEP Display indicates the pattern number. STEP of the PTN/STEP indicator lights up. While the STEP indicator is lit, the PTN/STEP Display indicates the step number. PTN of the PTN/STEP indicator lights up. Action indicators light up depending on the operation status.</p>
Monitor mode	<p>By pressing the PTN key during program control RUN, the unit enters Monitor mode. The PV Display indicates PV, and the SV Display indicates MV. Each time the PTN key is pressed, SV, MV or remaining time is indicated.</p>	
Setting mode	<p>Pattern setting mode</p>	<p>Sets the following: Step SV, Step time, PID block number, number of repetitions and pattern link.</p>
	<p>Event setting mode</p>	<p>Sets the following: EV□ alarm value, Time signal TS1 output OFF time, Time signal TS1 output ON time</p>
	<p>Control parameter setting mode</p>	<p>Sets the following: AT Perform/Cancel, OUT1 proportional band, Integral time, Derivative time, ARW, OUT2 proportional band (When EV2, DS, DA or EV3D□ option is ordered), Direct/Reverse action, Loop break alarm, etc.</p>
	<p>Wait parameter setting mode</p>	<p>Sets the following: Wait value, Wait function Enabled/Disabled for each step</p>
	<p>Engineering setting mode 1</p>	<p>Sets the following: Set vlaue lock, Sensor correction, PV filter time constant, Communication parameters (When C5W or C5 option is ordered)</p>
	<p>Engineering setting mode 2</p>	<p>Sets the following: Input type, Scaling high limit, Scaling low limit, Event output EV□ allocation, Step time unit, Power restore action, etc.</p>
Data clear	<p>By pressing the ▲, ▼ and STOP keys (in that order) together for approx. 3 seconds during program control STOP (in Standby), Data clear Yes/No appears. To clear data, select YES, and press the MODE key. The PV Display indicates ! 0! for approx. 3 seconds, and all data reverts to their factory default values.</p>	

5.2 Registering Settings and Selections

• How to increase/decrease setting values

To increase or decrease the set value (numeric value), use the  or  key.

If the  or  key is pressed with the **FAST** key simultaneously, makes the numeric value change faster.

To switch the selection items, use the  or  key.

• How to register setting data or selection data

To register the settings or selections, use the **MODE** or **DISP** key.

If the **MODE** key is pressed, the set values (numerical values) or selected item are registered, and moves to the next setting item.

If the **MODE** key is pressed at the last setting item, the unit returns to the 1st setting item.

If the **DISP** key is pressed, the set values (numerical values) or selected item are registered, and moves back to the previous setting item.

If the **DISP** key is pressed at the 1st setting item, the unit moves back to the last setting item.

• How to return to RUN mode

To return to RUN mode, use the **RST** key.

If the **RST** key is pressed, the set values (numerical values) or selected item will be registered, and the unit will revert to RUN mode.

5.3 How to Read Setting Items

Step 1 SV will be used for the explanation.

Explanation of setting items:

- Upper left: PV Display: Indicates setting characters.

- Lower left: PTN/STEP Display, SV Display

The PTN/STEP Display indicates the pattern number or step number. Indication differs depending on the setting item.

The SV Display indicates factory default value.

- Right side: Indicates the setting item or selection item, explanation of its function and setting range (or selection items).

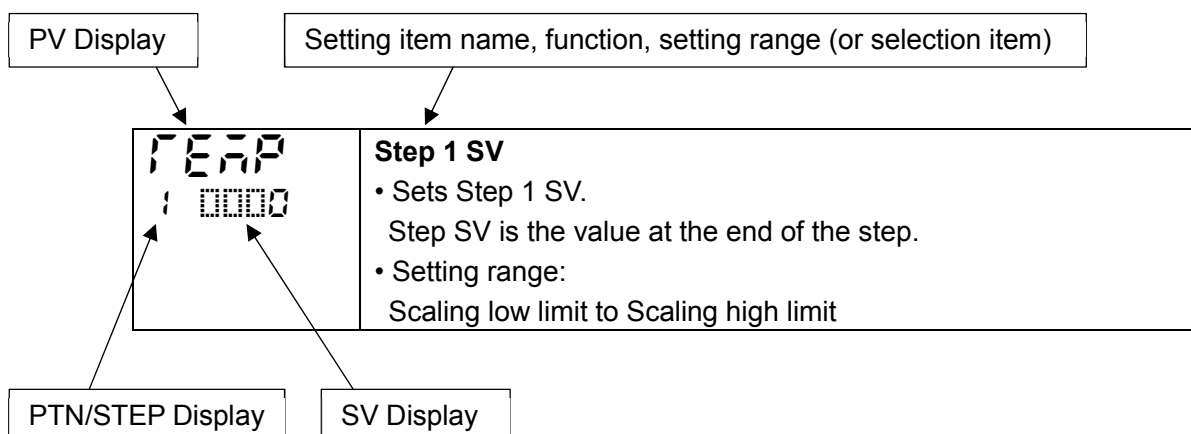

6. Initial Settings

Setup (setting the Input type, Scaling high limit, Scaling low limit, Event output EV1 allocation, Step time unit, Power restore action, Direct/Reverse action, etc.) should be done before using this controller, according to the user's conditions.

Perform setup (or initial settings) in Engineering setting mode 2 and Control parameter setting mode.

Initial setting items and their factory default values are shown below in (Table 6-1).

If the user's specification is the same as the factory default value of this instrument, or if user's instrument has already been installed in a system after initial settings are finished, initial settings are not necessary.



Proceed to Section "7. Basic Settings and Operation" (p.38).

(Table 6-1)

Initial Setting Item	Factory Default
Engineering setting mode 2	
Input type	K -200 to 1370°C
Scaling high limit	1370°C
Scaling low limit	-200°C
Decimal point place	No decimal point
Event output EV1 allocation	No event
Step time unit	Hours : Minutes
Power restore action	Stops after power is restored.
Step SV when program control starts	0°C
Program control start type	PV start
Control parameter setting mode	
OUT1 proportional cycle	Relay contact output: 30 sec Non-contact voltage output: 3 sec
Direct/Reverse action	Reverse action



The following shows the procedure for initial settings.















(1) Enter Engineering setting mode 2.

In RUN mode, press ,  and **MODE** keys (in that order) together for approx. 3 seconds. The unit will enter Engineering setting mode 2.

Characters, Factory Default	Setting Item, Function, Setting Range
	Input type • Selects an input type from thermocouple (10 types), RTD (2 types), direct current (2 types) and DC voltage (4 type), and the unit °C/°F. • When changing the input from DC voltage to other inputs, remove the sensor connected to this controller first, then change the input. If the input is changed with the sensor connected, the input circuit may break. • When changing an input type, refer to Section "9.6 Items to be Initialized by Changing Settings" (p.109). • Selection item:
	K -200 to 1370 °C
	K -200.0 to 400.0 °C

Characters, Factory Default	Setting Item, Function, Setting Range	
J00C	J	-200 to 1000 °C
r00C	R	0 to 1760 °C
S00C	S	0 to 1760 °C
b00C	B	0 to 1820 °C
E00C	E	-200 to 800 °C
T00C	T	-200.0 to 400.0 °C
N00C	N	-200 to 1300 °C
PL2C	PL-II	0 to 1390 °C
C00C	C(W/Re5-26)	0 to 2315 °C
Pt1C	Pt100	-200.0 to 850.0 °C
JPt1C	JPt100	-200.0 to 500.0 °C
Pt10C	Pt100	-200 to 850 °C
JPt10C	JPt100	-200 to 500 °C
K00F	K	-328 to 2498 °F
K00F	K	-328.0 to 752.0 °F
J00F	J	-328 to 1832 °F
r00F	R	32 to 3200 °F
S00F	S	32 to 3200 °F
b00F	B	32 to 3308 °F
E00F	E	-328 to 1472 °F
T00F	T	-328.0 to 752.0 °F
N00F	N	-328 to 2372 °F
PL2F	PL-II	32 to 2534 °F
C00F	C(W/Re5-26)	32 to 4199 °F
Pt1F	Pt100	-328.0 to 1562.0 °F
JPt1F	JPt100	-328.0 to 932.0 °F
Pt10F	Pt100	-328 to 1562 °F
JPt10F	JPt100	-328 to 932 °F
420A	4 to 20 mA	-2000 to 10000
020A	0 to 20 mA	-2000 to 10000
001V	0 to 1 V	-2000 to 10000
005V	0 to 5 V	-2000 to 10000
105V	1 to 5 V	-2000 to 10000
010V	0 to 10 V	-2000 to 10000
SFLH 0 1370	Scaling high limit <ul style="list-style-type: none"> • Sets scaling high limit value. • Setting range: Scaling low limit to Input range high limit DC voltage, current inputs: -2000 to 10000 (The placement of the decimal point follows the selection.) 	
SFLL 0 -200	Scaling low limit <ul style="list-style-type: none"> • Sets scaling low limit value. • Setting range: Input range low limit to Scaling high limit DC voltage, current inputs: -2000 to 10000 (The placement of the decimal point follows the selection.) 	

Characters, Factory Default	Setting Item, Function, Setting Range	
	Decimal point place • Selects decimal point place. • Selection item:	
	0000	No decimal point
	0000	1 digit after decimal point
	0000	2 digits after decimal point
	0000	3 digits after decimal point
	Available only when DC voltage or current input is selected in [Input type].	
	Event output EV1 allocation • Selects Event output EV1 from the table below. • If Event output EV1 is changed, some setting items will be initialized. Refer to Section “9.6 Items to be Initialized by Changing Settings” (p.109). • Selection item:	
	0000	No event
	0001	Alarm output, High limit alarm
	0002	Alarm output, Low limit alarm
	0003	Alarm output, High/Low limits alarm
	0004	Alarm output, High/Low limits independent alarm
	0005	Alarm output, High/Low limit range alarm
	0006	Alarm output, High/Low limit range independent alarm
	0007	Alarm output, Process high alarm
	0008	Alarm output, Process low alarm
	0009	Alarm output, High limit with standby alarm
	0010	Alarm output, Low limit with standby alarm
	0011	Alarm output, High/Low limits with standby alarm
	0012	Alarm output, High/Low limits with standby independent alarm
	0013	Heater burnout alarm output (when C5W, EIW or W option is ordered): Detects load current value with CT (current transformer), and turns ON if it is lower than heater burnout alarm value.
0014	Loop break alarm output: Sets Loop break alarm time and span. • About the Loop break alarm: When the control action is Reverse (Heating) control: If the PV does not reach the Loop break alarm span setting within the time allotted to assess the Loop break alarm (after the MV has reached 100% or the OUT1 high limit value), the alarm output will be turned ON. Likewise, if the PV does not drop to the Loop break alarm span setting within the time allotted to assess the Loop break alarm (after the MV has reached 0% or the OUT1 low limit value), the alarm output will be turned ON. When the control action is Direct (Cooling) control: If the PV does not drop to the Loop break alarm span setting within the time allotted to assess the Loop break alarm (after the MV has reached 100% or the OUT1 high limit value), the alarm output will be turned ON.	

Characters, Factory Default	Setting Item, Function, Setting Range	
		<p>Likewise, if the PV does not reach the Loop break alarm span setting within the time allotted to assess the Loop break alarm (after the MV has reached 0% or the OUT1 low limit value), the alarm output will be turned ON.</p> <p>• When EV2 option (If “ Heating/Cooling control output” is selected in [Event output EV2 allocation]) is ordered, or DS, DA or EV3D option is ordered.</p> <p>When the control action is Reverse (Heating) control: After OUT1 MV has reached 100% or the OUT1 high limit value, or after OUT2 MV has reached 0% or -(OUT2 low limit value), if the PV does not reach the Loop break alarm span setting within the time allotted to assess the Loop break alarm, the alarm output will be turned ON.</p> <p>Likewise, after OUT1 MV has reached 0% or the OUT1 low limit value, or after OUT2 MV has reached -100% or -(OUT2 high limit value), if the PV does not drop to the Loop break alarm span setting within the time allotted to assess the Loop break alarm, the alarm output will be turned ON.</p> <p>When the control action is Direct (Cooling) control: After OUT1 MV has reached 100% or the OUT1 high limit value, or after OUT2 MV has reached 0% or -(OUT2 low limit value), if the PV does not drop to the Loop break alarm span setting within the time allotted to assess the Loop break alarm, the alarm output will be turned ON.</p> <p>Likewise, after OUT1 MV has reached 0% or the OUT1 low limit value, or after OUT2 MV has reached -100% or -(OUT2 high limit value), if the PV does not reach the Loop break alarm span setting within the time allotted to assess the Loop break alarm, the alarm output will be turned ON.</p>
		<p>Time signal output: Turns ON during program control RUN, by setting Time signal output OFF time and ON time within total time in one pattern.</p>
		Output during AT: Turns ON during AT.
		<p>Pattern end output: Turns ON after Program control ends, and remains ON during the time set in [Pattern end output time].</p>
		<p>Output by communication command: Communication command 8004H B0 EV1 output 0: OFF, 1: ON B1 EV2 output 0: OFF, 1: ON B2 EV3 output 0: OFF, 1: ON</p>
		RUN output: Turns ON during program control RUN.
	<p>When  (High limit alarm) to  (High/Low limits with standby independent alarm) or  (Time signal output) is selected, one alarm can be set to one event output.</p> <p>When  (Heater burnout alarm output),  (Loop break alarm output) or  (Output during AT) to  (RUN output) are selected, each output is common to multiple event outputs.</p>	

• **About alarm output**

EV1 alarm output actions are shown below.

• **High limit alarm**

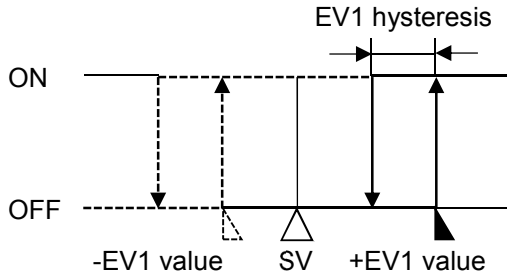

(Fig. 6-1)

• **Low limit alarm**

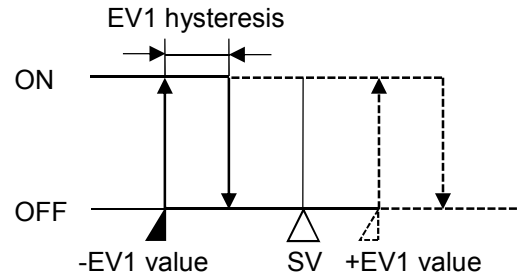

(Fig. 6-2)

• **High/Low limits alarm**

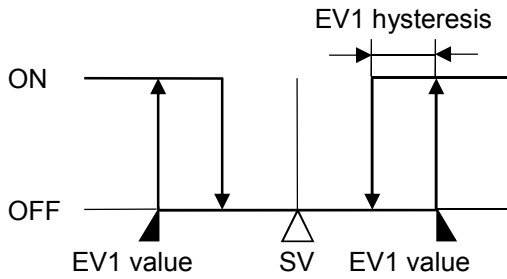

(Fig. 6-3)

• **High/Low limits independent alarm**

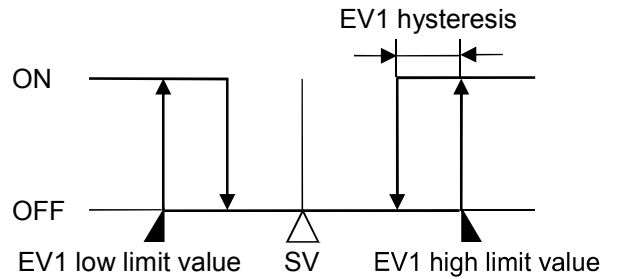

(Fig. 6-4)

• **High/Low limit range alarm**

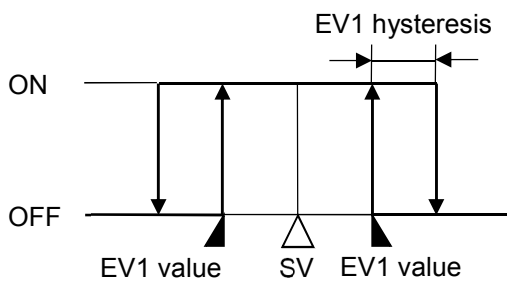

(Fig. 6-5)

• **High/Low limit range independent alarm**

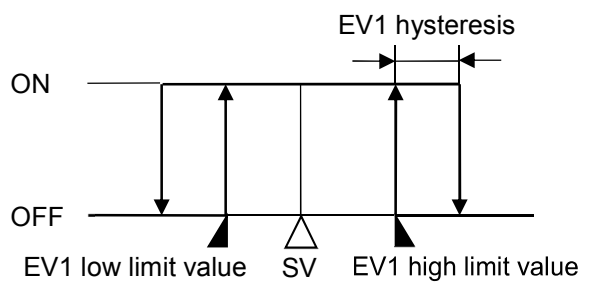

(Fig. 6-6)

• **Process high alarm**

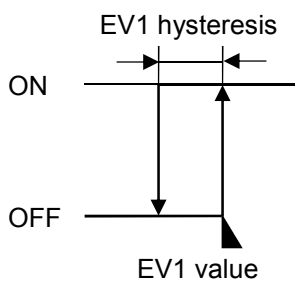

(Fig. 6-7)

• **Process low alarm**

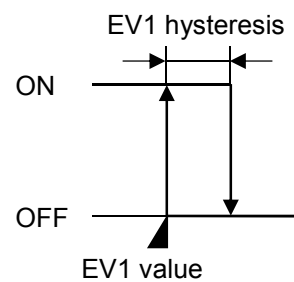

(Fig. 6-8)

- **High limit with standby alarm**

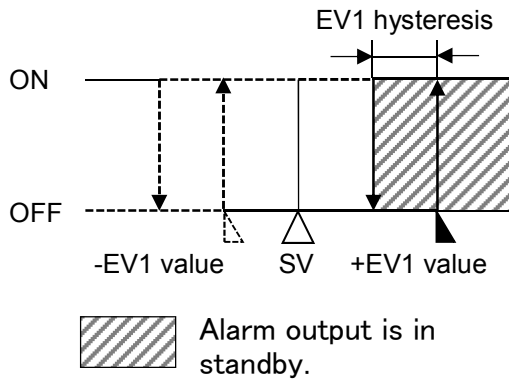

(Fig. 6-9)

- **Low limit with standby alarm**

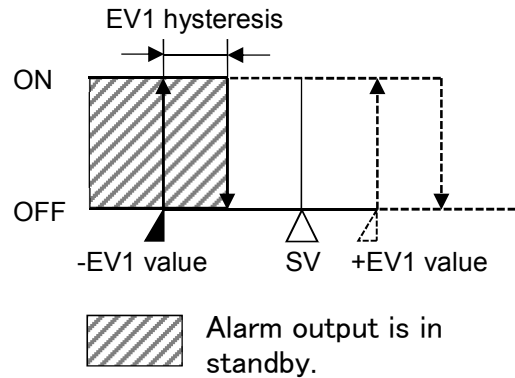

(Fig. 6-10)

- **High/Low limits with standby alarm**

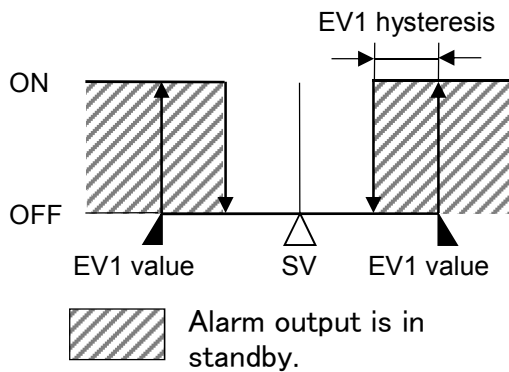

(Fig. 6-11)

- **High/Low limits with standby independent alarm**

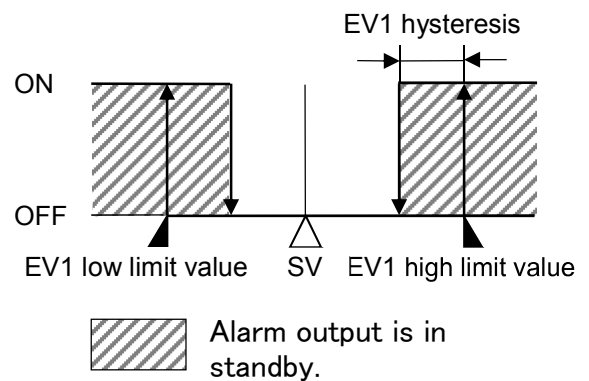

(Fig. 6-12)

- **About Time signal output**

Time signal output OFF time and Time signal output ON time are set within total time in one pattern. After program control starts, Time signal output turns ON during Time signal output ON time after Time signal output OFF time has elapsed.

During Wait action or program control HOLD, progress time of Time signal output stops.

When step time is changed during program control RUN, Time signal output timing is re-calculated using the changed pattern time.

Example of program pattern setting

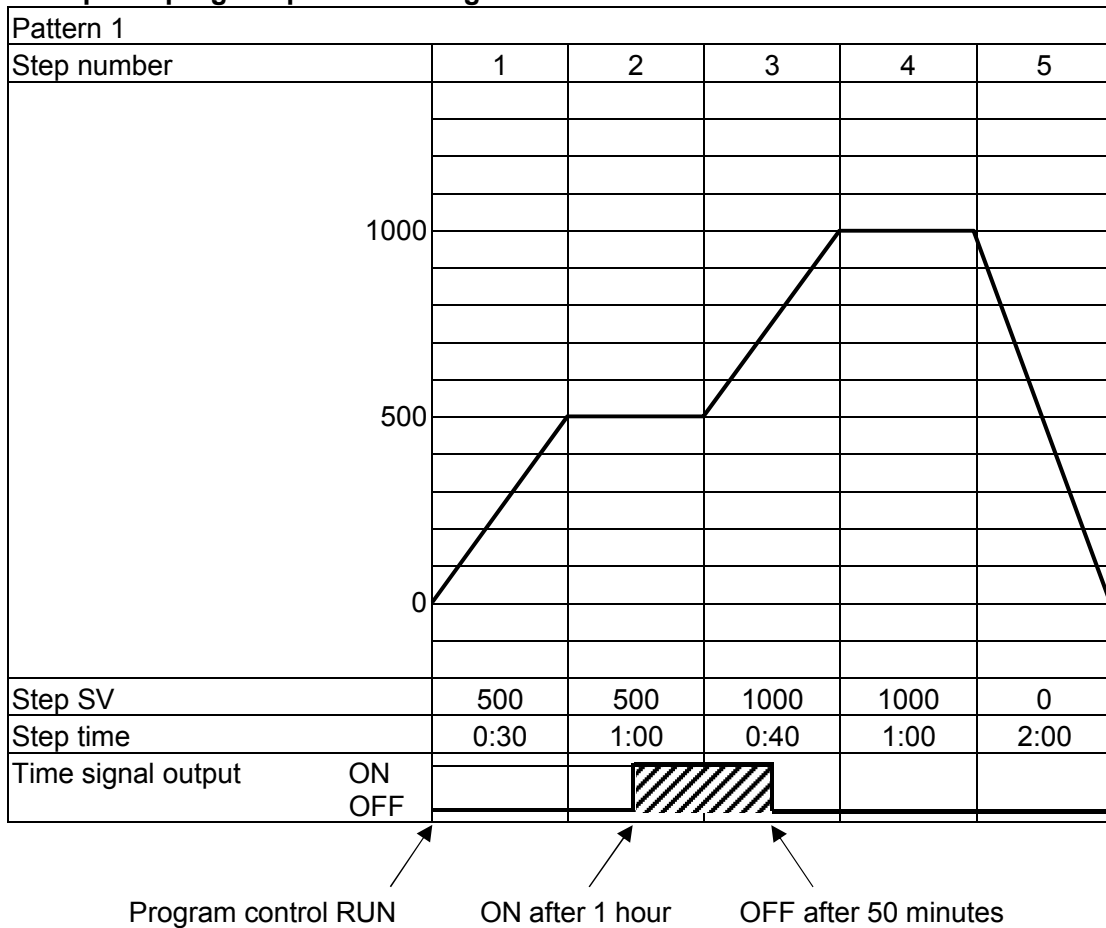

(e.g.) Time signal output setting

Time signal output OFF time: 1 hour

Time signal output ON time: 50 minutes

(Fig. 6-13)

Explanation of Time signal output

In the above program pattern example, Time signal output turns ON one hour after program control RUN starts (30 minutes after the unit entered Step 2). Time signal output turns OFF 50 minutes after Time signal output turned ON (20 minutes after the unit entered Step 3).



Characters, Factory Default	Setting Item, Function, Setting Range
Press the MODE key multiple times until the following characters appear.	
 	Step time unit <ul style="list-style-type: none"> • Selects the Step time unit. • Selection item:
	Hours : Minutes
	Minutes : Seconds

Characters, Factory Default	Setting Item, Function, Setting Range
P-ET 0 STOP	Power restore action • If the power fails during program control RUN, the controller can be operated depending on the selection in [Power restore action]. • Selection item:
	STOP Stops after power is restored: After power is restored, stops current program control, and returns to the program control STOP (in Standby).
	CONT Continues after power is restored: After power is restored, continues (resumes) previous program control.
	Hold Suspends after power is restored After power is restored, suspends (on hold) current program control, and performs Fixed value control using the step SV at the time of suspension. Pressing the RUN key cancels suspension, and Program control resumes.
S-SV 0 0000	Step SV when program control starts • Sets step SV when program control starts. • Setting range: Scaling low limit to Scaling high limit (The placement of the decimal point follows the selection.)
S-SL 0 P800	Program control start type • Program control start type can be selected. • Selection item:
	P800 PV start Only when program control starts, the step SV and step time are advanced to the PV, then program control starts.
	P8-0 PVR start When program control starts and in pattern repeating, the step SV and step time are advanced to the PV, then program control starts.
	S800 SV start Program control starts from the value set in [Step SV when program control starts].
Press the RST key. The unit returns to RUN mode.	

(2) Control parameter setting mode.

In RUN mode, press the  and **MODE** keys (in that order) together. The unit enters Control parameter setting mode.

Characters, Factory Default	Setting Item, Function, Setting Range
AT 00 0 ----	AT Perform/Cancel Do not perform AT during initial settings.

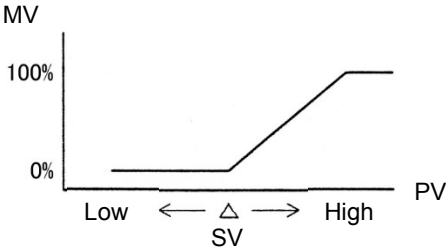
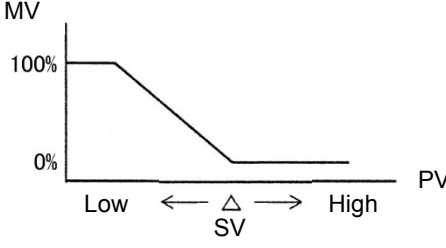
Characters, Factory Default	Setting Item, Function, Setting Range				
Press the MODE key multiple times until the following characters appear.					
	<p>OUT1 proportional cycle</p> <ul style="list-style-type: none"> • Sets OUT1 proportional cycle. • For the relay contact output type, if the proportional cycle time is decreased, the frequency of the relay action increases, and the life of the relay contact is shortened. <p>Factory default value differs depending on the output type as follows:</p> <ul style="list-style-type: none"> Relay contact output type: 30 seconds Non-contact voltage output type: 3 seconds Direct current output type: Not available <ul style="list-style-type: none"> • Setting range: 0.5, 1 to 120 seconds <p>Available when OUT1 is relay contact output or non-contact voltage output.</p>				
Press the MODE key multiple times until the following characters appear.					
	<p>Direct/Reverse action</p> <ul style="list-style-type: none"> • Selects either Direct (Cooling) or Reverse (Heating) control action. <p>Direct action: In Direct action, MV is increased when PV is higher than SV (positive deviation). Refrigerators perform Direct action.</p>  <p>(Fig. 6-14)</p> <p>Reverse action: In Reverse action, MV is increased when SV is higher than PV (negative deviation). Electric furnaces perform Reverse action.</p>  <p>(Fig. 6-15)</p> <ul style="list-style-type: none"> • Selection item: <table border="1" data-bbox="453 1877 1481 1960"> <tr> <td>HEAT</td> <td>Reverse action</td> </tr> <tr> <td>cool</td> <td>Direct action</td> </tr> </table>	HEAT	Reverse action	cool	Direct action
HEAT	Reverse action				
cool	Direct action				
Press the RST key. The unit returns to RUN mode.					

At this stage, the initial settings are complete.

Refer to Sections '7. Basic Settings and Operation (p.38)' and '8. Explanation of Setting Items (p.44)'.

7. Basic Settings and Operation

7.1 Procedure of Basic Settings and Operation

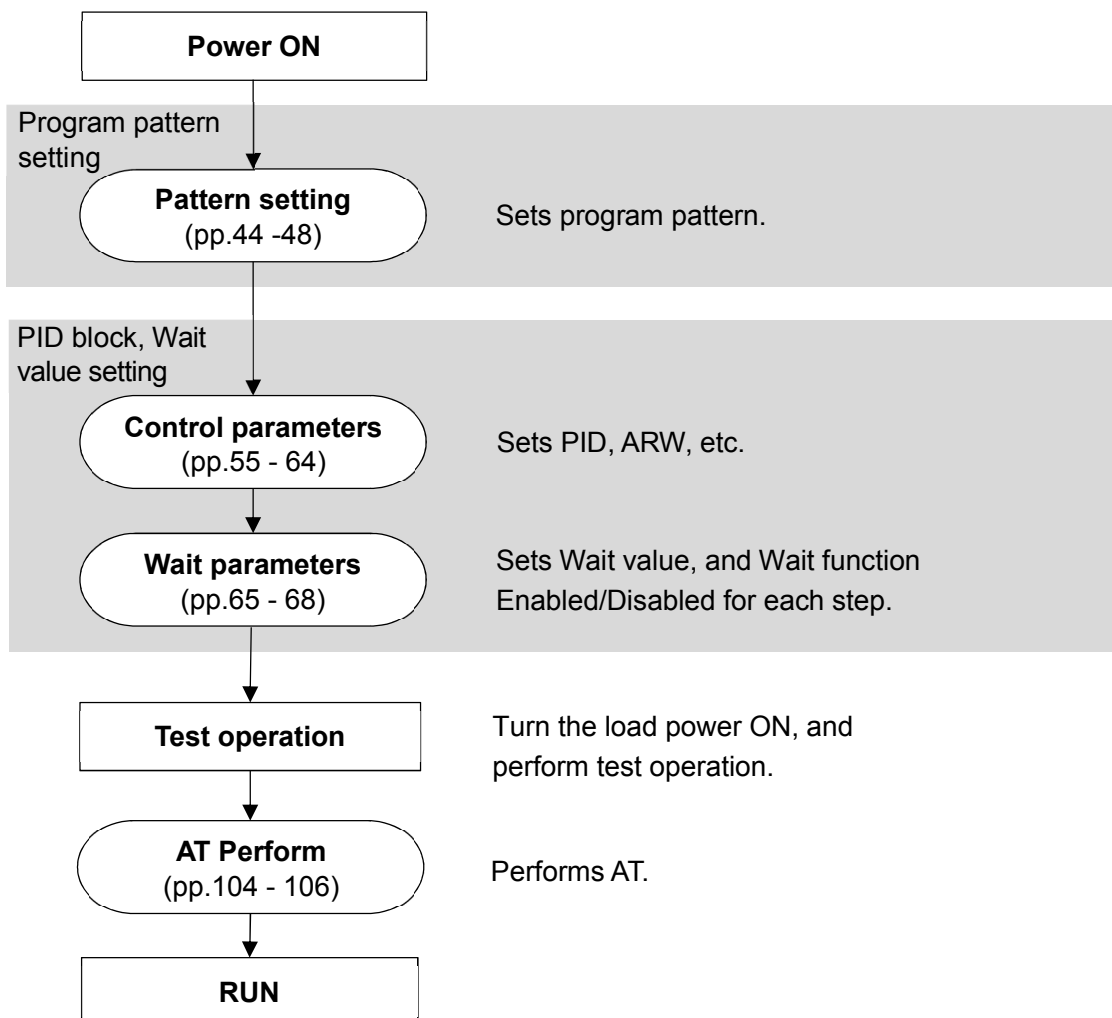

(Fig. 7.1-1)

The operation method is described below, based on the program pattern, PID block and wait value settings.

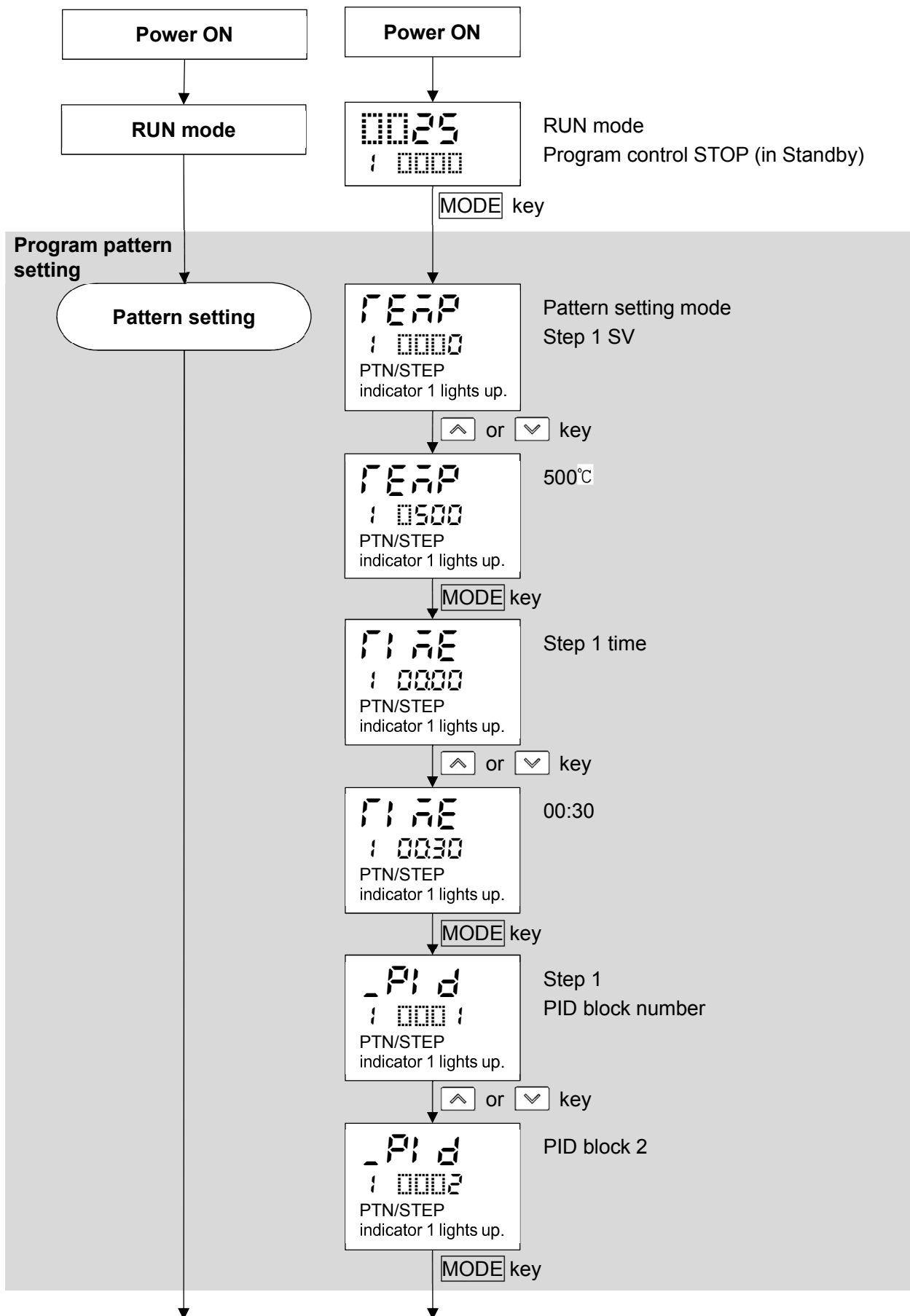

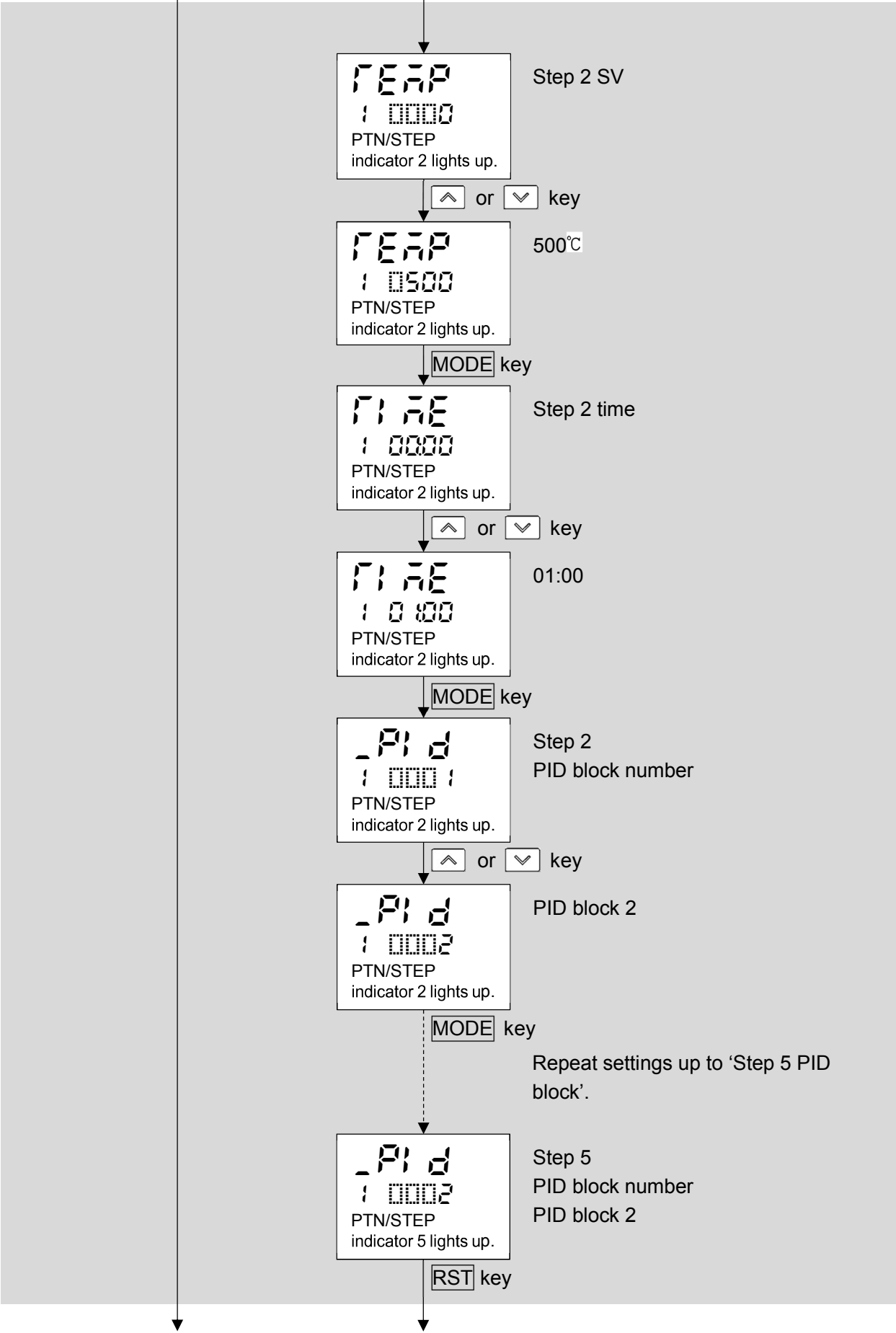

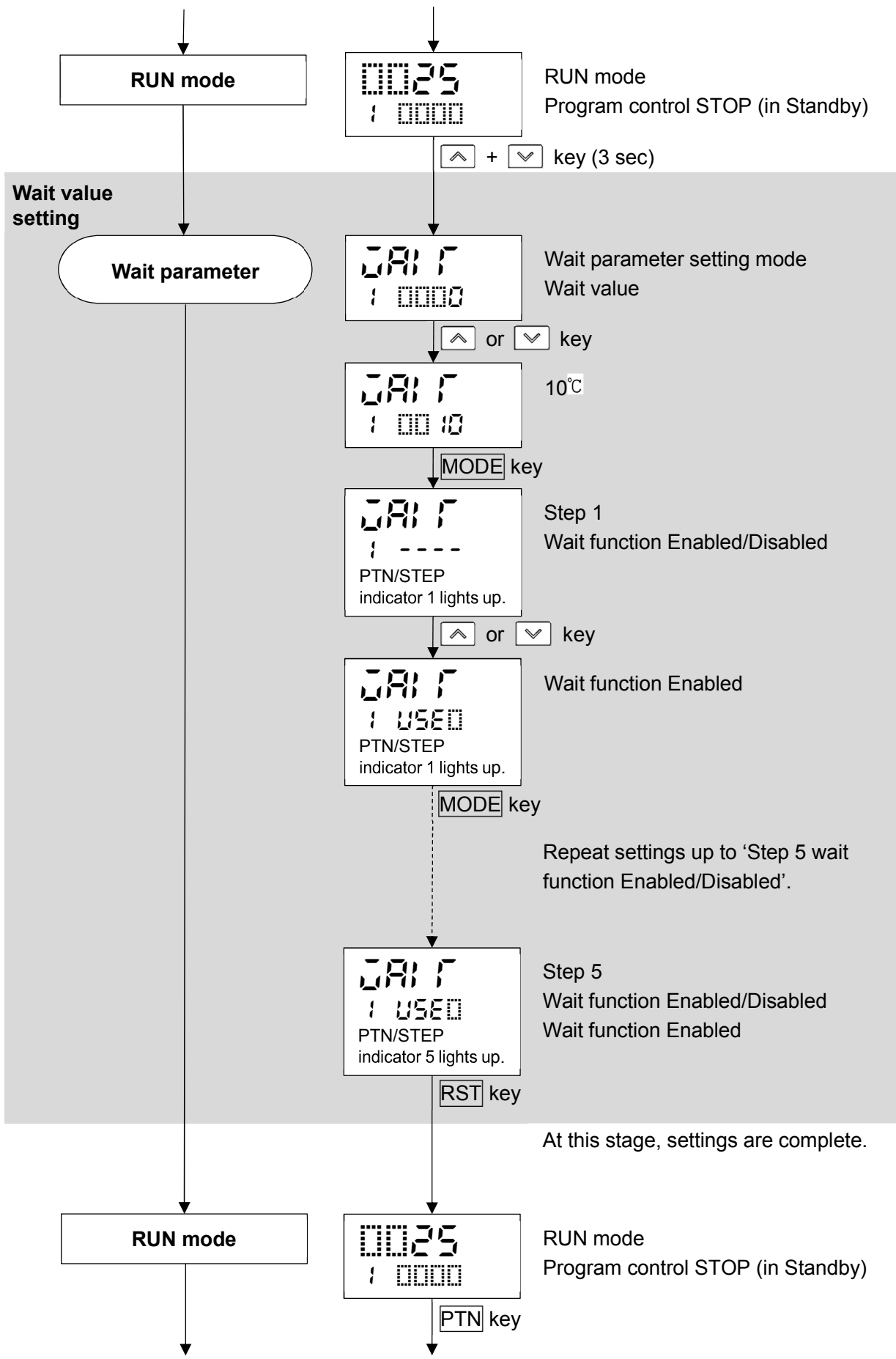

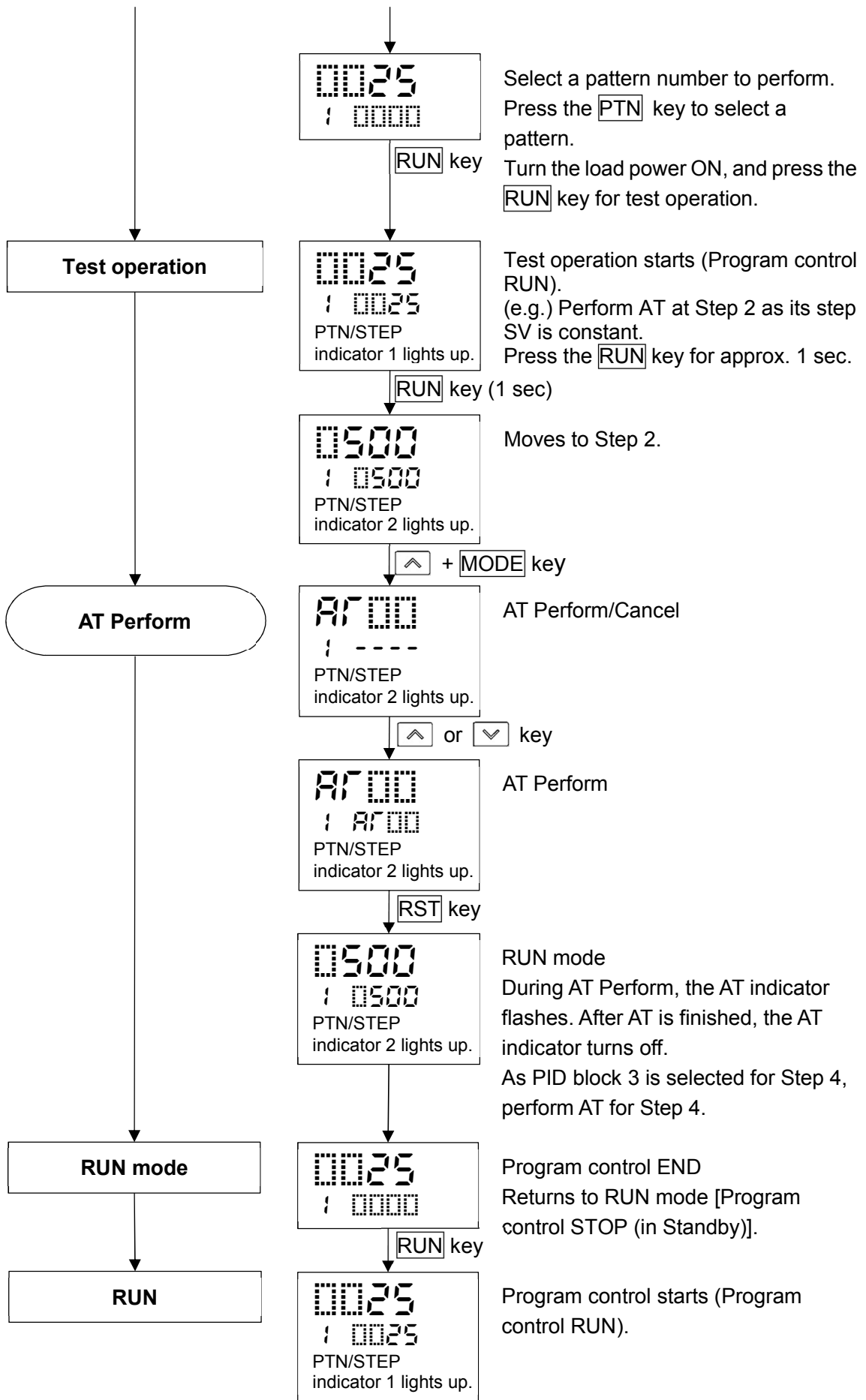

8. Explanation of Setting Items

Setting items for the following mode will be described:

Pattern setting mode, Event setting mode, Control parameter setting mode, Wait parameter setting mode, Engineering setting mode 1, Engineering setting mode 2.

8.1 Setting Items in Pattern Setting Mode

In Pattern setting mode, the following items are set:

Step SV, Step time, PID block number, Number of repetitions, pattern link

Settings are performed for the pattern selected when entering Pattern setting mode.

During program control RUN, settings are possible only for the currently performing pattern.

If 'Pattern link Enabled' is selected in [Pattern link]: Even if the performing pattern is changed from 1 to 2 during pattern setting mode, Pattern 1 will be remained, and the pattern number will not be updated until the unit reverts to RUN mode.

• Before entering Pattern setting mode







Select a pattern number with the key before entering Pattern setting mode.

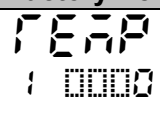
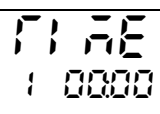
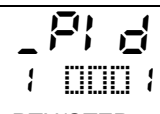
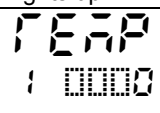







• To enter Pattern setting mode







In RUN mode, press the key. The unit enters Pattern setting mode.





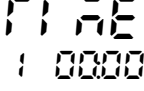



Pattern 1 is used for the explanation of setting items in Pattern setting mode.

Characters, Factory Default	Setting Item, Function, Setting Range
 PTN/STEP indicator 1 lights up.	Step 1 SV <ul style="list-style-type: none"> Sets Step 1 SV. Step SV is a value (SV) at the end of the step. Setting range: Scaling low limit to Scaling high limit
 PTN/STEP indicator 1 lights up.	Step 1 time <ul style="list-style-type: none"> Sets Step 1 time. Step time is the processing time of the step. Setting range: - - - -, 00:00 to 99.59 (Time unit follows the selection in [Step time unit].) If the <input type="checkbox"/> key is pressed at 00:00, - - - - will appear. If - - - - is set, Fixed value control will be performed using Step 1 SV.
 PTN/STEP indicator 1 lights up.	Step 1 PID block number <ul style="list-style-type: none"> Selects PID block number used for Step 1. Selection item: 1 to 10
 PTN/STEP indicator 2 lights up.	Step 2 SV <ul style="list-style-type: none"> Sets Step 2 SV. Step SV is a value (SV) at the end of the step. Setting range: Scaling low limit to Scaling high limit

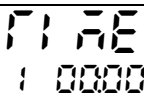
Characters, Factory Default	Setting Item, Function, Setting Range
 <p>PTN/STEP indicator 2 lights up.</p>	<p>Step 2 time</p> <ul style="list-style-type: none"> • Sets Step 2 time. <p>Step time is the processing time of the step.</p> <ul style="list-style-type: none"> • Setting range: - - - - , 00:00 to 99.59 (Time unit follows the selection in [Step time unit].) If the <input type="checkbox"/> key is pressed at 00:00, - - - - will appear. If - - - - is set, Fixed value control will be performed using Step 2 SV.
 <p>PTN/STEP indicator 2 lights up.</p>	<p>Step 2 PID block number</p> <ul style="list-style-type: none"> • Selects PID block number used for Step 2. • Selection item: 1 to 10
 <p>PTN/STEP indicator 3 lights up.</p>	<p>Step 3 SV</p> <ul style="list-style-type: none"> • Sets Step 3 SV. <p>Step SV is a value (SV) at the end of the step.</p> <ul style="list-style-type: none"> • Setting range: Scaling low limit to Scaling high limit
 <p>PTN/STEP indicator 3 lights up.</p>	<p>Step 3 time</p> <ul style="list-style-type: none"> • Sets Step 3 time. <p>Step time is the processing time of the step.</p> <ul style="list-style-type: none"> • Setting range: - - - - , 00:00 to 99.59 (Time unit follows the selection in [Step time unit].) If the <input type="checkbox"/> key is pressed at 00:00, - - - - will appear. If - - - - is set, Fixed value control will be performed using Step 3 SV.
 <p>PTN/STEP indicator 3 lights up.</p>	<p>Step 3 PID block number</p> <ul style="list-style-type: none"> • Selects PID block number used for Step 3. • Selection item: 1 to 10
 <p>PTN/STEP indicator 4 lights up.</p>	<p>Step 4 SV</p> <ul style="list-style-type: none"> • Sets Step 4 SV. <p>Step SV is a value (SV) at the end of the step.</p> <ul style="list-style-type: none"> • Setting range: Scaling low limit to Scaling high limit
 <p>PTN/STEP indicator 4 lights up.</p>	<p>Step 4 time</p> <ul style="list-style-type: none"> • Sets Step 4 time. <p>Step time is the processing time of the step.</p> <ul style="list-style-type: none"> • Setting range: - - - - , 00:00 to 99.59 (Time unit follows the selection in [Step time unit].) If the <input type="checkbox"/> key is pressed at 00:00, - - - - will appear. If - - - - is set, Fixed value control will be performed using Step 4 SV.

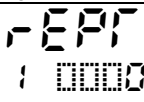
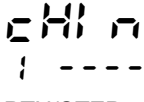
Characters, Factory Default	Setting Item, Function, Setting Range
 PTN/STEP indicator 4 lights up.	Step 4 PID block number <ul style="list-style-type: none"> • Selects PID block number used for Step 4. • Selection item: 1 to 10
 PTN/STEP indicator 5 lights up.	Step 5 SV <ul style="list-style-type: none"> • Sets Step 5 SV. Step SV is a value (SV) at the end of the step. • Setting range: Scaling low limit to Scaling high limit
 PTN/STEP indicator 5 lights up.	Step 5 time <ul style="list-style-type: none"> • Sets Step 5 time. Step time is the processing time of the step. • Setting range: ----, 00:00 to 99.59 (Time unit follows the selection in [Step time unit].) If the <input type="checkbox"/> key is pressed at 00:00, ---- will appear. If ---- is set, Fixed value control will be performed using Step 5 SV.
 PTN/STEP indicator 5 lights up.	Step 5 PID block number <ul style="list-style-type: none"> • Selects PID block number used for Step 5. • Selection item: 1 to 10
 PTN/STEP indicator 6 lights up.	Step 6 SV <ul style="list-style-type: none"> • Sets Step 6 SV. Step SV is a value (SV) at the end of the step. • Setting range: Scaling low limit to Scaling high limit
 PTN/STEP indicator 6 lights up.	Step 6 time <ul style="list-style-type: none"> • Sets Step 6 time. Step time is the processing time of the step. • Setting range: ----, 00:00 to 99.59 (Time unit follows the selection in [Step time unit].) If the <input type="checkbox"/> key is pressed at 00:00, ---- will appear. If ---- is set, Fixed value control will be performed using Step 6 SV.
 PTN/STEP indicator 6 lights up.	Step 6 PID block number <ul style="list-style-type: none"> • Selects PID block number used for Step 6. • Selection item: 1 to 10
 PTN/STEP indicator 7 lights up.	Step 7 SV <ul style="list-style-type: none"> • Sets Step 7 SV. Step SV is a value (SV) at the end of the step. • Setting range: Scaling low limit to Scaling high limit

Characters, Factory Default	Setting Item, Function, Setting Range
 PTN/STEP indicator 7 lights up.	Step 7 time <ul style="list-style-type: none"> • Sets Step 7 time. Step time is the processing time of the step. <ul style="list-style-type: none"> • Setting range: <ul style="list-style-type: none"> - - - - , 00:00 to 99.59 (Time unit follows the selection in [Step time unit].) If the <input type="checkbox"/> key is pressed at 00:00, - - - - will appear. If - - - - is set, Fixed value control will be performed using Step 7 SV.
 PTN/STEP indicator 7 lights up.	Step 7 PID block number <ul style="list-style-type: none"> • Selects PID block number used for Step 7. • Selection item: <ul style="list-style-type: none"> 1 to 10
 PTN/STEP indicator 8 lights up.	Step 8 SV <ul style="list-style-type: none"> • Sets Step 8 SV. Step SV is a value (SV) at the end of the step. <ul style="list-style-type: none"> • Setting range: <ul style="list-style-type: none"> Scaling low limit to Scaling high limit
 PTN/STEP indicator 8 lights up.	Step 8 time <ul style="list-style-type: none"> • Sets Step 8 time. Step time is the processing time of the step. <ul style="list-style-type: none"> • Setting range: <ul style="list-style-type: none"> - - - - , 00:00 to 99.59 (Time unit follows the selection in [Step time unit].) If the <input type="checkbox"/> key is pressed at 00:00, - - - - will appear. If - - - - is set, Fixed value control will be performed using Step 8 SV.
 PTN/STEP indicator 8 lights up.	Step 8 PID block number <ul style="list-style-type: none"> • Selects PID block number used for Step 8. • Selection item: <ul style="list-style-type: none"> 1 to 10
 PTN/STEP indicator 9 lights up.	Step 9 SV <ul style="list-style-type: none"> • Sets Step 9 SV. Step SV is a value (SV) at the end of the step. <ul style="list-style-type: none"> • Setting range: <ul style="list-style-type: none"> Scaling low limit to Scaling high limit
 PTN/STEP indicator 9 lights up.	Step 9 time <ul style="list-style-type: none"> • Sets Step 9 time. Step time is the processing time of the step. <ul style="list-style-type: none"> • Setting range: <ul style="list-style-type: none"> - - - - , 00:00 to 99.59 (Time unit follows the selection in [Step time unit].) If the <input type="checkbox"/> key is pressed at 00:00, - - - - will appear. If - - - - is set, Fixed value control will be performed using Step 9 SV.

Characters, Factory Default	Setting Item, Function, Setting Range				
 PTN/STEP indicator 9 lights up.	Step 9 PID block number <ul style="list-style-type: none"> • Selects PID block number used for Step 9. • Selection item: 1 to 10 				
 PTN/STEP indicator 10 lights up.	Step 10 SV <ul style="list-style-type: none"> • Sets Step 10 SV. Step SV is a value (SV) at the end of the step. • Setting range: Scaling low limit to Scaling high limit 				
 PTN/STEP indicator 10 lights up.	Step 10 time <ul style="list-style-type: none"> • Sets Step 10 time. Step time is the processing time of the step. • Setting range: - - - -, 00:00 to 99.59 (Time unit follows the selection in [Step time unit].) If the <input type="checkbox"/> key is pressed at 00:00, - - - - will appear. If - - - - is set, Fixed value control will be performed using Step 10 SV. 				
 PTN/STEP indicator 10 lights up.	Step 10 PID block number <ul style="list-style-type: none"> • Selects PID block number used for Step 10. • Selection item: 1 to 10 				
 PTN/STEP indicator turns off.	Number of repetitions <ul style="list-style-type: none"> • Sets the number of repetitions for the selected Pattern 1 • Setting range: 0 to 10000 				
 PTN/STEP indicator turns off.	Pattern link <ul style="list-style-type: none"> • Selects whether to link Pattern 2 to currently selected pattern 1. If Pattern 10 is selected, Pattern 1 can be linked, and selects whether to link Pattern 1. Randomly selected pattern numbers (Pattern 1 and Pattern 5) cannot be linked. For repetitions of linked pattern, the whole linked pattern will be repeated as many times as set in [Number of repetitions]. (e.g.) If patterns 1 and 2 are linked, and if the number of repetitions of pattern 1 is set to 2 times, the whole linked pattern (Patterns 1 and 2) will be repeated twice. • Selection item: <table border="1" style="width: 100%; border-collapse: collapse;"> <tr> <td style="text-align: center;">- - - -</td> <td>Pattern link Disabled</td> </tr> <tr> <td style="text-align: center;"></td> <td>Pattern link Enabled</td> </tr> </table>	- - - -	Pattern link Disabled		Pattern link Enabled
- - - -	Pattern link Disabled				
	Pattern link Enabled				

At this stage, settings for Pattern setting mode are complete.

Press the key. The unit reverts to RUN mode.

8.2 Setting Items in Event Setting Mode

Setting items in Event Setting Mode differs depending on the selection in [Event output EV□ allocation]. If 001 (High limit alarm) to 012 (High/Low limits alarm with standby independent alarm) are selected in [Event output EV□ allocation], EV□ alarm value will be set.

If 015 (Time signal output) is selected in [Event output EV□ allocation], TS□ output OFF time and TS□ output ON time can be set.

Settings are performed for the pattern number selected when entering Event setting mode.

Setting values are common to all steps in each pattern.

During program control RUN, only the performing pattern can be set.

If 'Pattern link Enabled' is selected in [Pattern link]: Even if the performing pattern is changed from 1 to 2 during Event setting mode, Pattern 1 will be remained, and pattern number will not be updated until the unit reverts to RUN mode.

• About alarm output

EV1 alarm output actions are shown below.

EV1 alarm output will be substituted by EV2 or EV3 alarm output.

• High limit alarm

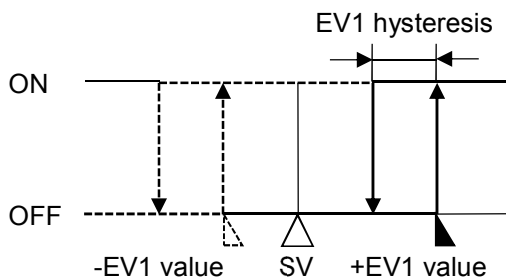

(Fig. 8.2-1)

• Low limit alarm

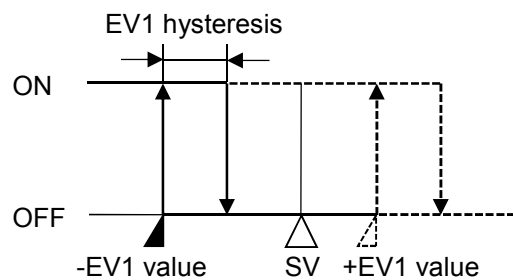

(Fig. 8.2-2)

• High/Low limits alarm

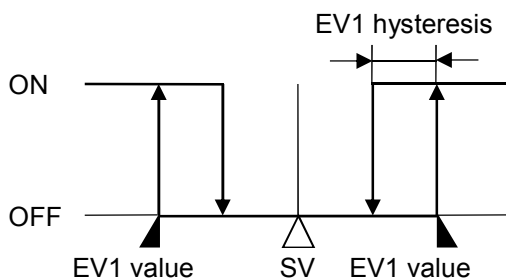

(Fig. 8.2-3)

• High/Low limits independent alarm

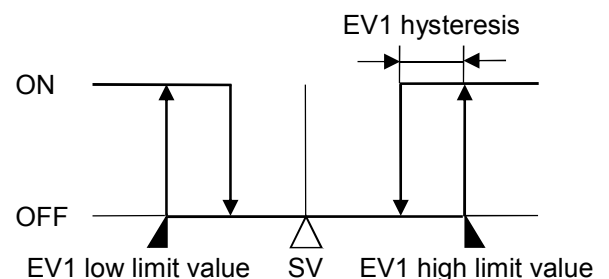

(Fig. 8.2-4)

• High/Low limit range alarm

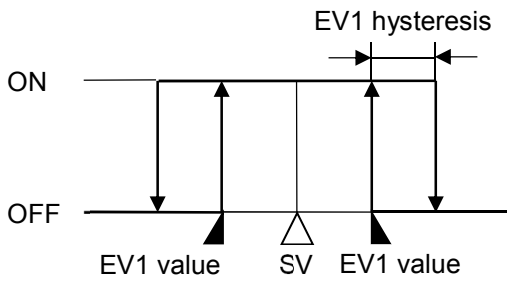

(Fig. 8.2-5)

• High/Low limit range independent alarm

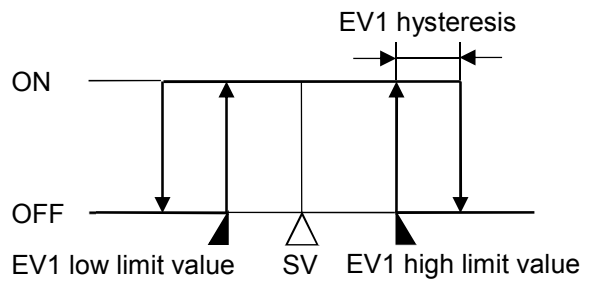

(Fig. 8.2-6)

• Process high alarm

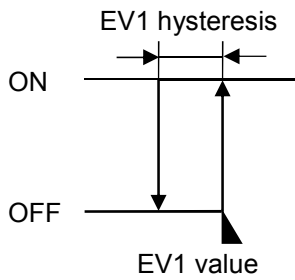

(Fig. 8.2-7)

• Process low alarm

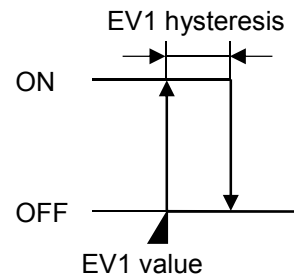

(Fig. 8.2-8)

• High limit with standby alarm

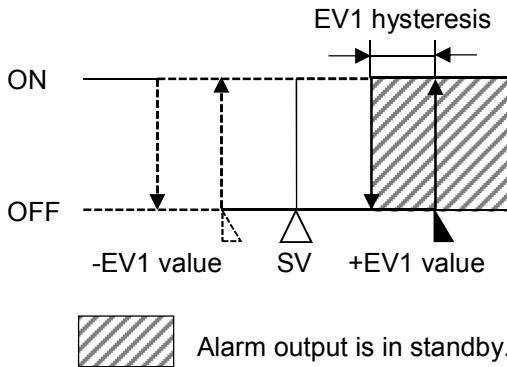

(Fig. 8.2-9)

• Low limit with standby alarm

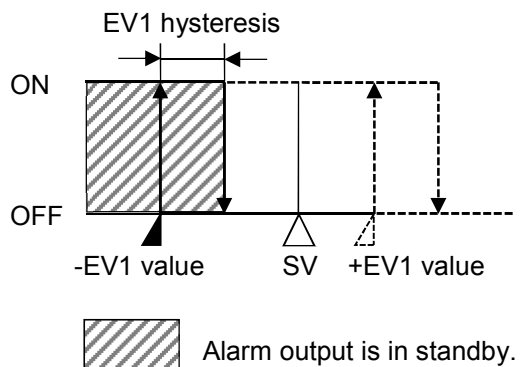

(Fig. 8.2-10)

• High/Low limits with standby alarm

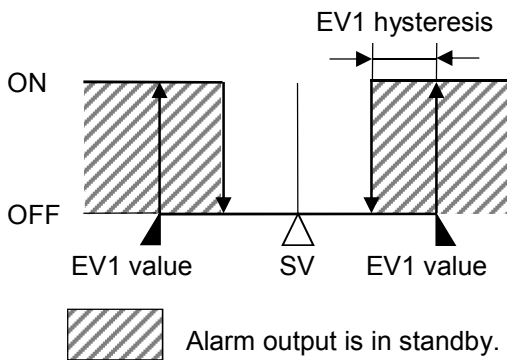

(Fig. 8.2-11)

• High/Low limits with standby independent alarm

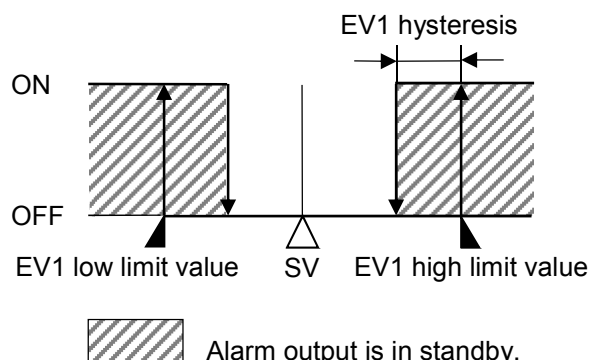

(Fig. 8.2-12)

• **Time signal output**

Time signal output OFF time and Time signal output ON time are set within one pattern total time. After program control starts, Time signal output activates during Time signal output ON time after Time signal output OFF time has elapsed.

During Wait action or program control HOLD, progress time of Time signal output stops.

When Step time is changed during program control RUN, Time signal output timing is re-calculated using the pattern time after change.

Program pattern setting example

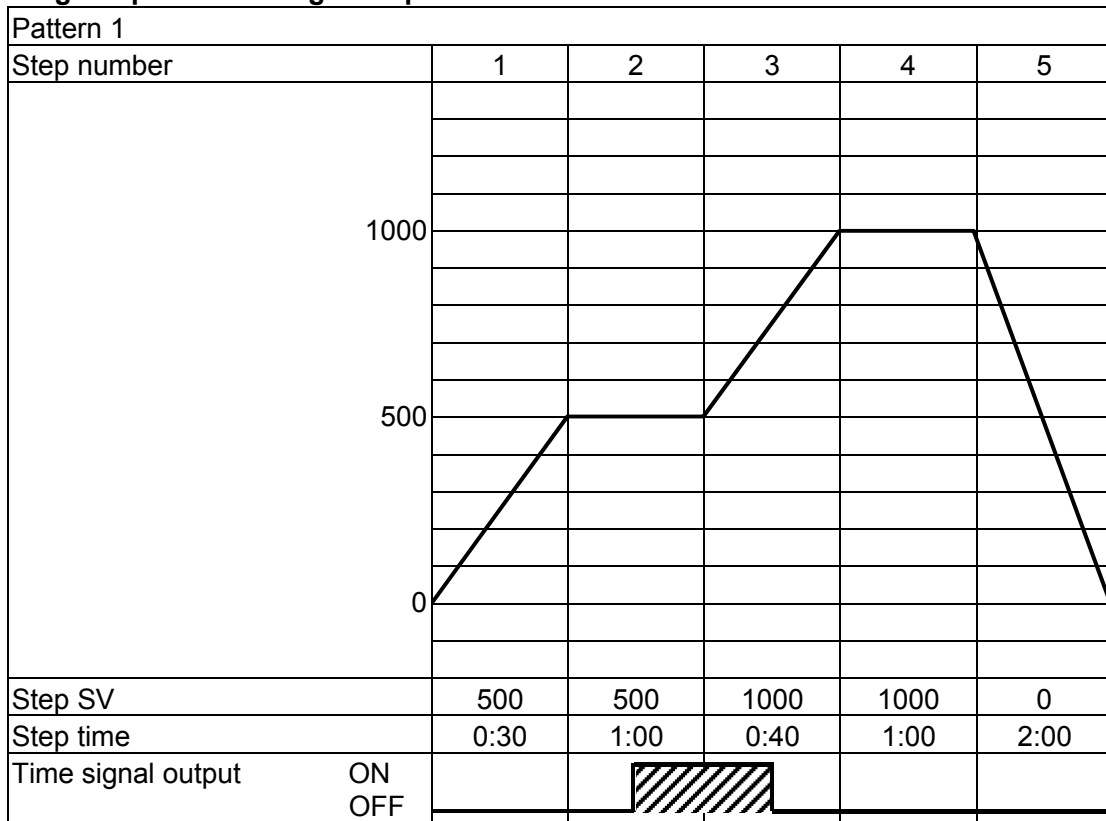

Program control RUN ON after 1 hour OFF after 50 minutes

(e.g.) Time signal output setting

Time signal output OFF time: 1 hour

Time signal output ON time: 50 minutes

(Fig. 8.2-13)

Explanation of Time signal output

In the above program pattern example, Time signal output turns ON one hour after program control RUN starts (30 minutes after the unit entered Step 2). Time signal output turns OFF 50 minutes after Time signal output turned ON (20 minutes after the unit entered Step 3).

• **Before entering Event setting mode**





















Select a pattern number with the **PTN** key before entering Event setting mode.





• **How to enter Event setting mode**

In RUN mode, press the **MODE** key for approx. 3 seconds to enter Event setting mode.

Setting items in Event Setting mode are shown below.

Characters, Factory Default	Setting Item, Function, Setting Range																								
	<p>EV1 alarm value</p> <ul style="list-style-type: none"> • Sets EV1 alarm value. <p>EV1 alarm value matches EV1 low limit alarm value in the following cases: 004 (High/Low limits independent alarm), 006 (High/Low limit range independent alarm) or 012 (High/Low limits with standby independent alarm) is selected in [Event output EV1 allocation].</p> <ul style="list-style-type: none"> • Setting range: <table style="width: 100%; border-collapse: collapse;"> <tr> <td style="padding-left: 20px;">High limit alarm</td> <td style="text-align: right;">-(Input span) to Input span (*1)</td> </tr> <tr> <td style="padding-left: 20px;">Low limit alarm</td> <td style="text-align: right;">-(Input span) to Input span (*1)</td> </tr> <tr> <td style="padding-left: 20px;">High/Low limits alarm</td> <td style="text-align: right;">0 to Input span (*1)</td> </tr> <tr> <td style="padding-left: 20px;">High/Low limits independent alarm</td> <td style="text-align: right;">0 to Input span (*1)</td> </tr> <tr> <td style="padding-left: 20px;">High/Low limit range alarm</td> <td style="text-align: right;">0 to Input span (*1)</td> </tr> <tr> <td style="padding-left: 20px;">High/Low limit range independent alarm</td> <td style="text-align: right;">0 to Input span (*1)</td> </tr> <tr> <td style="padding-left: 20px;">Process high alarm</td> <td style="text-align: right;">Input range low limit to Input range high limit (*2)</td> </tr> <tr> <td style="padding-left: 20px;">Process low alarm</td> <td style="text-align: right;">Input range low limit to Input range high limit (*2)</td> </tr> <tr> <td style="padding-left: 20px;">High limit with standby alarm</td> <td style="text-align: right;">-(Input span) to Input span (*1)</td> </tr> <tr> <td style="padding-left: 20px;">Low limit with standby alarm</td> <td style="text-align: right;">-(Input span) to Input span (*1)</td> </tr> <tr> <td style="padding-left: 20px;">High/Low limits with standby alarm</td> <td style="text-align: right;">0 to Input span (*1)</td> </tr> <tr> <td style="padding-left: 20px;">High/Low limits with standby independent alarm</td> <td style="text-align: right;">0 to Input span (*1)</td> </tr> </table> <p>(*1) For DC voltage, current inputs, the input span is the same as the scaling span. (The placement of the decimal point follows the selection.)</p> <p>(*2) For DC voltage, current inputs, input range low (or high) limit value is the same as scaling low (or high) limit value. (The placement of the decimal point follows the selection.)</p> <p>Available when 0001 (High limit alarm) to 0012 (High/Low limits with standby independent alarm) is selected in [Event output EV1 allocation].</p>	High limit alarm	-(Input span) to Input span (*1)	Low limit alarm	-(Input span) to Input span (*1)	High/Low limits alarm	0 to Input span (*1)	High/Low limits independent alarm	0 to Input span (*1)	High/Low limit range alarm	0 to Input span (*1)	High/Low limit range independent alarm	0 to Input span (*1)	Process high alarm	Input range low limit to Input range high limit (*2)	Process low alarm	Input range low limit to Input range high limit (*2)	High limit with standby alarm	-(Input span) to Input span (*1)	Low limit with standby alarm	-(Input span) to Input span (*1)	High/Low limits with standby alarm	0 to Input span (*1)	High/Low limits with standby independent alarm	0 to Input span (*1)
High limit alarm	-(Input span) to Input span (*1)																								
Low limit alarm	-(Input span) to Input span (*1)																								
High/Low limits alarm	0 to Input span (*1)																								
High/Low limits independent alarm	0 to Input span (*1)																								
High/Low limit range alarm	0 to Input span (*1)																								
High/Low limit range independent alarm	0 to Input span (*1)																								
Process high alarm	Input range low limit to Input range high limit (*2)																								
Process low alarm	Input range low limit to Input range high limit (*2)																								
High limit with standby alarm	-(Input span) to Input span (*1)																								
Low limit with standby alarm	-(Input span) to Input span (*1)																								
High/Low limits with standby alarm	0 to Input span (*1)																								
High/Low limits with standby independent alarm	0 to Input span (*1)																								
	<p>EV1 high limit alarm value</p> <ul style="list-style-type: none"> • Sets EV1 high limit alarm value. • Setting range: Same as those of EV1 alarm value. <p>Available when 0004 (High/Low limits independent alarm), 0006 (High/Low limit range independent alarm) or 0012 (High/Low limits with standby independent alarm) is selected in [Event output EV1 allocation].</p>																								
	<p>TS1 output OFF time</p> <ul style="list-style-type: none"> • Sets TS1 output OFF time. • Setting range: 00:00 to 99:59 (Time unit follows the selection in [Step time unit].) <p>Available when 0015 (Time signal output) is selected in [Event output EV1 allocation].</p>																								

Characters, Factory Default	Setting Item, Function, Setting Range
	<p>TS1 output ON time</p> <ul style="list-style-type: none"> • Sets TS1 output ON time. • Setting range: 00:00 to 99:59 (Time unit follows the selection in [Step time unit].) Available when  (Time signal output) is selected in [Event output EV1 allocation].
	<p>EV2 alarm value</p> <ul style="list-style-type: none"> • Sets EV2 alarm value. EV2 alarm value matches EV2 low limit alarm value in the following cases: 004 (High/Low limits independent alarm), 006 (High/Low limit range independent alarm) or 012 (High/Low limits with standby independent alarm) is selected in [Event output EV2 allocation]. • Setting range: Same as those of EV1 alarm value. Available when  (High limit alarm) to  (High/Low limits with standby independent alarm) is selected in [Event output EV2 allocation].
	<p>EV2 high limit alarm value</p> <ul style="list-style-type: none"> • Sets EV2 high limit alarm value. • Setting range: Same as those of EV1 alarm value. Available when  (High/Low limits independent alarm),  (High/Low limit range independent alarm) or  (High/Low limits with standby independent alarm) is selected in [Event output EV2 allocation].
	<p>TS2 output OFF time</p> <ul style="list-style-type: none"> • Sets TS2 output OFF time. • Setting range: 00:00 to 99:59 (Time unit follows the selection in [Step time unit].) Available when  (Time signal output) is selected in [Event output EV2 allocation].
	<p>TS2 output ON time</p> <ul style="list-style-type: none"> • Sets TS2 output ON time. • Setting range: 00:00 to 99:59 (Time unit follows the selection in [Step time unit].) Available when  (Time signal output) is selected in [Event output EV2 allocation].
	<p>EV3 alarm value</p> <ul style="list-style-type: none"> • Sets EV3 alarm value. EV3 alarm value matches EV3 low limit alarm value in the following cases: 004 (High/Low limits independent alarm), 006 (High/Low limit range independent alarm) or 012 (High/Low limits with standby independent alarm) is selected in [Event output EV3 allocation]. • Setting range: Same as those of EV1 alarm value. Available when  (High limit alarm) to  (High/Low limits with standby independent alarm) is selected in [Event output EV3 allocation].
	<p>EV3 high limit alarm value</p> <ul style="list-style-type: none"> • Sets EV3 high limit alarm value. • Setting range: Same as those of EV1 alarm value. Available when  (High/Low limits independent alarm),  (High/Low limit range independent alarm) or  (High/Low limits with standby independent alarm) is selected in [Event output EV3 allocation].

Characters, Factory Default	Setting Item, Function, Setting Range
	<p>TS3 output OFF time</p> <ul style="list-style-type: none"> • Sets TS3 output OFF time. • Setting range: 00:00 to 99:59 (Time unit follows the selection in [Step time unit].) Available when  (Time signal output) is selected in [Event output EV3 allocation].
	<p>TS3 output ON time</p> <ul style="list-style-type: none"> • Sets TS3 output ON time. • Setting range: 00:00 to 99:59 (Time unit follows the selection in [Step time unit].) Available when  (Time signal output) is selected in [Event output EV3 allocation].

At this stage, settings for Event setting mode are complete.

Press the  key. The unit reverts to RUN mode.

8.3 Setting Items in Control Parameter Setting Mode





In Control parameter setting mode, the following setting items can be set:

AT Perform/Cancel, OUT1 proportional band, Integral time, derivative time, ARW, OUT2 proportional band (when EV2, DS, DA or EV3D□ option is ordered), Direct/Reverse action, Loop break alarm, etc. Setting data is common to all patterns.





• How to enter Control parameter setting mode

In RUN mode, press the  and **MODE** keys (in that order) together. The unit enters Control parameter setting mode.

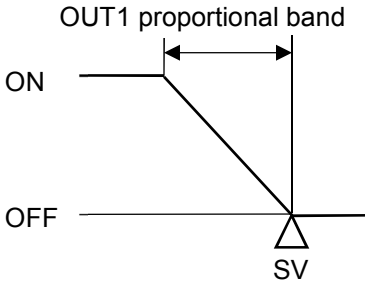
Setting items in Control parameter setting mode are shown below.

Characters, Factory Default	Setting Item, Function, Setting Range
	<p>AT Perform/Cancel</p> <ul style="list-style-type: none"> • Selects AT (auto-tuning) Perform/Cancel. AT will work only during program control RUN. After AT starts, and if AT has not been completed within 4 hours, or if input errors have occurred,  will be indicated on the PV Display, and AT will be forced to stop. • Selection item:
	<p style="text-align: center;">- - - -</p> <p style="text-align: center;">AT Cancel</p>
	<p style="text-align: center;"></p> <p style="text-align: center;">AT Perform</p>
	<p>PID block number</p> <ul style="list-style-type: none"> • Selects a PID block number from 1 to 10 for the following settings: OUT1 proportional band, Integral time, Derivative time, ARW, OUT2 proportional band [EV2(DR), DS, DA, EV3D□ options] <p>Refer to recommended usage of block numbers as follows:</p> <ul style="list-style-type: none"> Block 1: For Fixed value control Block 2: For low temperature program control Block 3: For medium temperature program control Block 4: For high temperature program control <ul style="list-style-type: none"> • Selection item: <p style="text-align: center;">1 to 10</p>

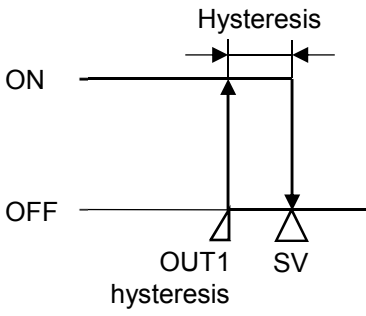
Characters, Factory Default	Setting Item, Function, Setting Range
P000 00 10	<p>OUT1 proportional band</p> <ul style="list-style-type: none"> Sets OUT1 proportional band for the PID block number selected in [PID block number]. The PTN/STEP Display indicates the PID block number selected in [PID block number]. OUT1 becomes ON/OFF control when set to 0 or 0.0.  <p>(Fig. 8.3-1)</p> <ul style="list-style-type: none"> Setting range: Thermocouple, RTD input without decimal point: 0 to input span$^{\circ}\text{C}$ ($^{\circ}\text{F}$) Thermocouple, RTD input with decimal point: 0.0 to input span$^{\circ}\text{C}$ ($^{\circ}\text{F}$) DC voltage, current inputs: 0.0 to 1000.0%
I 000 0200	<p>Integral time</p> <ul style="list-style-type: none"> Sets the integral time of the PID block number selected in [PID block number]. The PTN/STEP Display indicates the PID block number selected in [PID block number]. Setting range: 0 to 3600 seconds
d000 0050	<p>Derivative time</p> <ul style="list-style-type: none"> Sets the derivative time of the PID block number selected in [PID block number]. The PTN/STEP Display indicates the PID block number selected in [PID block number]. Setting range: 0 to 1800 seconds
A-00 0050	<p>ARW</p> <ul style="list-style-type: none"> Sets the ARW of the PID block number selected in [PID block number]. The PTN/STEP Display indicates the PID block number selected in [PID block number]. Setting range: 0 to 100%



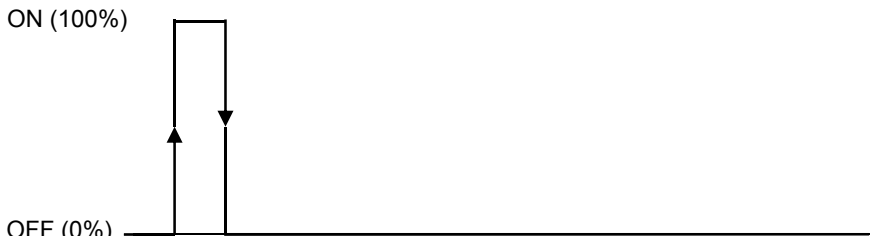
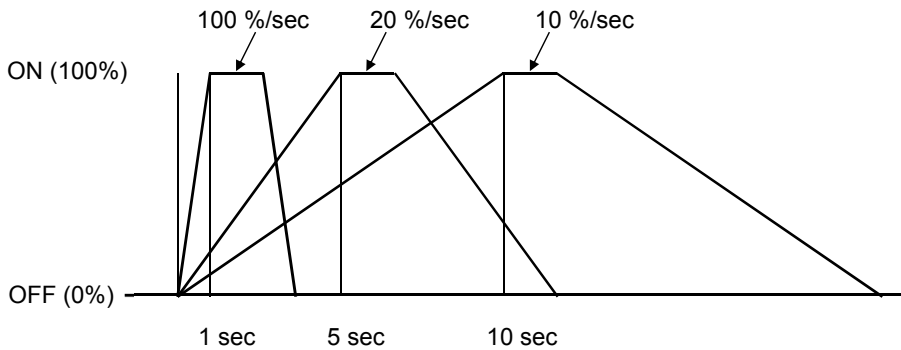

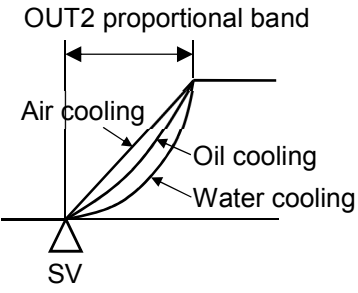
Characters, Factory Default	Setting Item, Function, Setting Range
	<p>OUT1 proportional cycle</p> <ul style="list-style-type: none"> Sets OUT1 proportional cycle. <p>For relay contact output, if the proportional cycle time is decreased, the frequency of the relay action increases, and the life of the relay contact is shortened.</p> <p>Factory default value is different depending on the output type.</p> <ul style="list-style-type: none"> Relay contact output: 30 seconds Non-contact voltage output: 3 seconds Direct current output: Not available <ul style="list-style-type: none"> Setting range: <ul style="list-style-type: none"> 0.5, 1 to 120 seconds <p>Available when OUT1 is relay contact output or non-contact voltage output type.</p>
	<p>OUT1 ON/OFF hysteresis</p> <ul style="list-style-type: none"> Sets ON/OFF hysteresis for OUT1.  <p>(Fig. 8.3-2)</p> <ul style="list-style-type: none"> Setting range: <ul style="list-style-type: none"> 0.1 to 1000.0°C (°F) DC voltage, current inputs: 1 to 10000 (The placement of the decimal point follows the selection.)
	<p>OUT1 high limit</p> <ul style="list-style-type: none"> Sets OUT1 high limit value. Setting range: <ul style="list-style-type: none"> OUT1 low limit to 100% Direct current output type: OUT1 low limit to 105%
	<p>OUT1 low limit</p> <ul style="list-style-type: none"> Sets OUT1 low limit value. Setting range: <ul style="list-style-type: none"> 0% to OUT1 high limit Direct current output type: -5% to OUT1 high limit

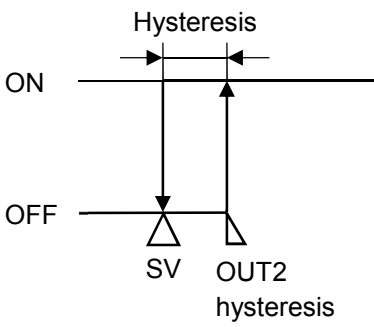
Characters, Factory Default	Setting Item, Function, Setting Range
	<p>OUT1 rate-of-change</p> <ul style="list-style-type: none"> • Sets changing value of OUT1 MV for 1 second. Setting the value to 0 disables this function. • About OUT1 rate-of-change: For Heating control, if PV is lower than SV, OUT1 MV is generally turned from OFF to ON as shown in (Fig. 8.3-3). If OUT1 rate-of-change is set, OUT1 MV can be changed by the rate-of-change as shown in (Fig. 8.3-4). This control is suitable for high temperature heaters (which are made from molybdenum, tungsten or platinum, etc., and used at approx. 1500 to 1800°C) which are easily burnt out from turning on electricity rapidly. • Setting range: 0 to 100 %/second Not available if OUT1 is in ON/OFF control. <div style="text-align: center;">  <p>(Fig. 8.3-3)</p> </div> <div style="text-align: center;">  <p>(Fig. 8.3-4)</p> </div> <ul style="list-style-type: none"> • Setting range: 0 to 100 %/second

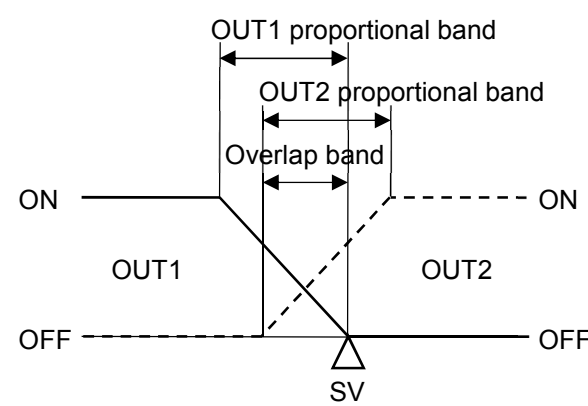
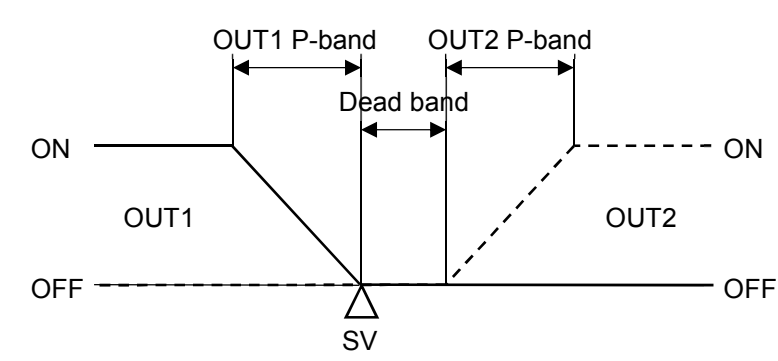
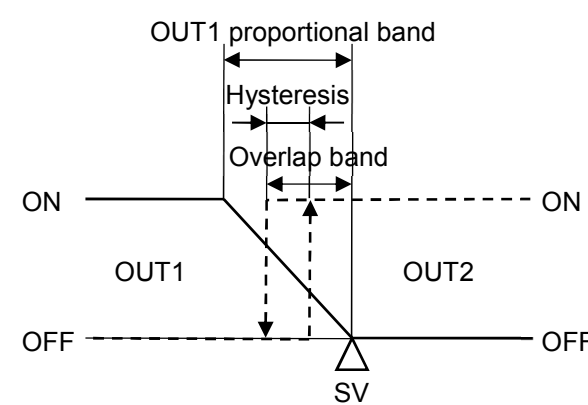

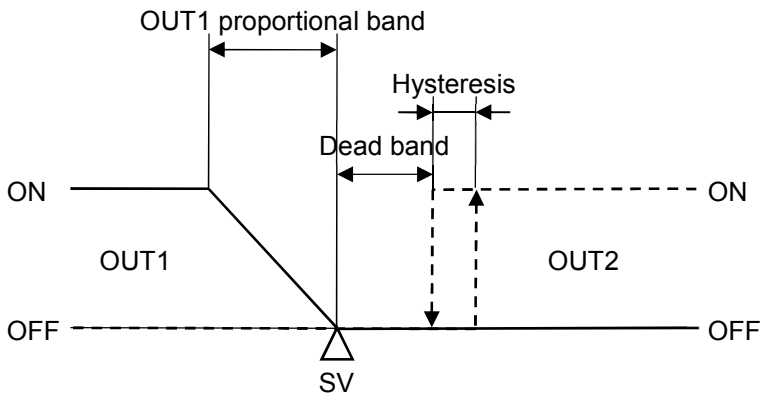
Characters, Factory Default	Setting Item, Function, Setting Range						
cAcI 0 Air0	<p>OUT2 cooling method</p> <ul style="list-style-type: none"> • Selects OUT2 cooling method from air, oil or water cooling.  <p>(Fig. 8.3-5)</p> <ul style="list-style-type: none"> • Selection item: <table border="1" data-bbox="502 750 1482 884"> <tr> <td data-bbox="502 750 606 795">Air0</td> <td data-bbox="606 750 1482 795">Air cooling (Linear characteristics)</td> </tr> <tr> <td data-bbox="502 795 606 840">oI0</td> <td data-bbox="606 795 1482 840">Oil cooling (1.5th power of the linear characteristics)</td> </tr> <tr> <td data-bbox="502 840 606 884">wAr0</td> <td data-bbox="606 840 1482 884">Water cooling (2nd power of the linear characteristics)</td> </tr> </table> <p>Available when EV2 option (if "0020 Heating/Cooling control output" is selected in [Event output EV2 allocation]) is ordered, or when DS, DA or EV3D□ option is ordered.</p>	Air0	Air cooling (Linear characteristics)	oI0	Oil cooling (1.5th power of the linear characteristics)	wAr0	Water cooling (2nd power of the linear characteristics)
Air0	Air cooling (Linear characteristics)						
oI0	Oil cooling (1.5th power of the linear characteristics)						
wAr0	Water cooling (2nd power of the linear characteristics)						
P_b0 1 00 10	<p>OUT2 proportional band</p> <ul style="list-style-type: none"> • Sets the OUT2 proportional band of the PID block number selected in [PID block number]. <p>The PTN/STEP Display indicates the PID block number selected in [PID block number].</p> <p>When set to 0 or 0.0, OUT2 becomes ON/OFF control, and the action selected in [OUT2 cooling method] will be disabled.</p> <ul style="list-style-type: none"> • Setting range: <p>Thermocouple, RTD input without decimal point: 0 to Input span°C (°F) Thermocouple, RTD input with decimal point: 0.0 to Input span°C (°F) DC voltage, current inputs: 0.0 to 1000.0%</p> <p>Available when EV2 option (if "0020 Heating/Cooling control output" is selected in [Event output EV2 allocation]) is ordered, or when DS, DA or EV3D□ option is ordered.</p>						
c_b0 00003	<p>OUT2 proportional cycle</p> <ul style="list-style-type: none"> • Sets OUT2 proportional cycle. <p>For relay contact output, if the proportional cycle time is decreased, the frequency of the relay action increases, and the life of the relay contact is shortened.</p> <p>Factory default value is different depending on the output type as follows:</p> <ul style="list-style-type: none"> Relay contact output [EV2, EV3(DR)]: 30 seconds Non-contact voltage output (DS, EV3DS): 3 seconds Direct current output (DA, EV3DA): Not available <ul style="list-style-type: none"> • Setting range: 0.5, 1 to 120 seconds <p>Available when EV2 option (When "0020 Heating/Cooling control output" is selected in [Event output EV2 allocation]) is ordered, or when DS, EV3(DR), EV3DS option is ordered.</p>						

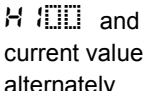
Characters, Factory Default	Setting Item, Function, Setting Range
<p>HYSb 0 00 0</p>	<p>OUT2 ON/OFF hysteresis</p> <ul style="list-style-type: none"> • Sets OUT2 ON/OFF hysteresis.  <p>(Fig. 8.3-6)</p> <ul style="list-style-type: none"> • Setting range: 0.1 to 1000.0°C (°F) DC voltage, current inputs: 1 to 10000 (The placement of the decimal point follows the selection.) <p>Available when EV2 option (if "0020 Heating/Cooling control output" is selected in [Event output EV2 allocation]) is ordered, or when DS, DA or EV3D□ option is ordered.</p>
<p>oLHb 0 0 100</p>	<p>OUT2 high limit</p> <ul style="list-style-type: none"> • Sets OUT2 high limit value. • Setting range: OUT2 low limit value to 100% <p>Direct current output type (DA, EV3DA options): OUT2 low limit value to 105%</p> <p>Available when EV2 option (if "0020 Heating/Cooling control output" is selected in [Event output EV2 allocation]) is ordered, or when DS, DA or EV3D□ option is ordered.</p>
<p>oLLb 0 0000</p>	<p>OUT2 low limit</p> <ul style="list-style-type: none"> • Sets OUT2 low limit value. • Setting range: 0% to OUT2 high limit value <p>Direct current output type (DA, EV3DA options): -5% to OUT2 high limit value</p> <p>Available when EV2 option (if "0020 Heating/Cooling control output" is selected in [Event output EV2 allocation]) is ordered, or when DS, DA or EV3D□ option is ordered.</p>

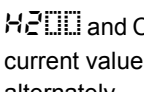
Characters, Factory Default	Setting Item, Function, Setting Range
	<p>Overlap/Dead band</p> <ul style="list-style-type: none"> • Sets the overlap band or dead band. + Set value: Dead band - Set value: Overlap band <p>Overlap band (When OUT1 and OUT2 are in PID control)</p>  <p>(Fig. 8.3-7)</p> <p>Dead band (When OUT1 and OUT2 are in PID control)</p>  <p>(Fig. 8.3-8)</p> <p>Overlap band (When OUT1 is in PID control, OUT2 is in ON/OFF control)</p>  <p>(Fig. 8.3-9)</p>

Characters, Factory Default	Setting Item, Function, Setting Range				
	<p>Dead band (When OUT1 is in PID control, OUT2 is in ON/OFF control)</p>  <p>(Fig. 8.3-10)</p> <ul style="list-style-type: none"> • Setting range: -200.0 to 200.0°C (°F) DC voltage, current inputs: -2000 to 2000 (The placement of the decimal point follows the selection.) <p>Available when EV2 option (if "020 Heating/Cooling control output" is selected in [Event output EV2 allocation]) is ordered, or when DS, DA or EV3D□ option is ordered.</p>				
	<p>Direct/Reverse action</p> <ul style="list-style-type: none"> • Selects either Direct (Cooling) or Reverse (Heating) control action. • Selection range: <table border="1" data-bbox="478 1153 925 1232"> <tr> <td>HEAT</td> <td>Reverse (Heating) action</td> </tr> <tr> <td>COOL</td> <td>Direct (Cooling) action</td> </tr> </table>	HEAT	Reverse (Heating) action	COOL	Direct (Cooling) action
HEAT	Reverse (Heating) action				
COOL	Direct (Cooling) action				
  H 000 and CT1 current value are alternately indicated.	<p>Heater burnout alarm 1 value</p> <ul style="list-style-type: none"> • Sets the detecting current value for Heater burnout alarm 1. <p>When setting to 0.0, Heater burnout alarm 1 is disabled.</p> <p>Characters H 000 and CT1 current value are indicated alternately on the PV Display.</p> <p>When OUT1 is ON, the CT1 current value is updated.</p> <p>When OUT1 is OFF, the unit memorizes the previous value when OUT1 was ON.</p> <p>Upon returning to set limits, the alarm will stop.</p> <ul style="list-style-type: none"> • Setting range: 20 A: 0.0 to 20.0 A 100 A: 0.0 to 100.0 A <p>Available when C5W, EIW, W option is ordered, and when OUT1 is relay contact output or non-contact voltage output type.</p>				
  H200 and CT2 current value are alternately indicated.	<p>Heater burnout alarm 2 value</p> <ul style="list-style-type: none"> • Sets the detecting current value for Heater burnout alarm 2. <p>Available only when using 3-phase.</p> <p>When setting to 0.0, Heater burnout alarm 2 is disabled.</p> <p>Characters H200 and CT2 current value are indicated alternately on the PV Display.</p> <p>When OUT1 is ON, the CT2 current value is updated.</p>				

Characters, Factory Default	Setting Item, Function, Setting Range
	<p>When OUT1 is OFF, the unit memorizes the previous value when OUT1 was ON.</p> <p>Upon returning to set limits, the alarm will stop.</p> <ul style="list-style-type: none"> Setting range: <ul style="list-style-type: none"> 20 A: 0.0 to 20.0 A 100 A: 0.0 to 100.0 A <p>Available when C5W, EIW, W option is ordered, and when OUT1 is relay contact output or non-contact voltage output type.</p>
	<p>Loop break alarm time</p> <ul style="list-style-type: none"> Sets the time to assess the Loop break alarm. Setting to 0 (zero) disables the alarm. About the Loop break alarm: <p>When the control action is Reverse (Heating) control: If the PV does not reach the Loop break alarm span setting within the time allotted to assess the Loop break alarm (after the MV has reached 100% or the OUT1 high limit value), the alarm output will be turned ON. Likewise, if the PV does not drop to the Loop break alarm span setting within the time allotted to assess the Loop break alarm (after the MV has reached 0% or the OUT1 low limit value), the alarm output will be turned ON.</p> <p>When the control action is Direct (Cooling) control: If the PV does not drop to the Loop break alarm span setting within the time allotted to assess the Loop break alarm (after the MV has reached 100% or the OUT1 high limit value), the alarm output will be turned ON. Likewise, if the PV does not reach the Loop break alarm span setting within the time allotted to assess the Loop break alarm (after the MV has reached 0% or the OUT1 low limit value), the alarm output will be turned ON.</p> When EV2 option (if "020 Heating/Cooling control output" is selected in [Event output EV2 allocation]) is ordered, or when DS, DA or EV3D□ option is ordered. <p>When the control action is Reverse (Heating) control: After OUT1 MV has reached 100% or the OUT1 high limit value, or after OUT2 MV has reached 0% or -(OUT2 low limit value), if the PV does not reach the Loop break alarm span setting within the time allotted to assess the Loop break alarm, the alarm output will be turned ON. Likewise, after OUT1 MV has reached 0% or the OUT1 low limit value, or after OUT2 MV has reached -100% or -(OUT2 high limit value), if the PV does not drop to the Loop break alarm span setting within the time allotted to assess the Loop break alarm, the alarm output will be turned ON.</p> <p>When the control action is Direct (Cooling) control: After OUT1 MV has reached 100% or the OUT1 high limit value, or after OUT2 MV has reached 0% or -(OUT2 low limit value), if the PV does not drop to the Loop break alarm span setting within the time allotted to assess the Loop break alarm, the alarm output will be turned ON.</p>

Characters, Factory Default	Setting Item, Function, Setting Range
	<p>Likewise, after OUT1 MV has reached 0% or the OUT1 low limit value, or after OUT2 MV has reached -100% or -(OUT2 high limit value), if the PV does not reach the Loop break alarm span setting within the time allotted to assess the Loop break alarm, the alarm output will be turned ON.</p> <ul style="list-style-type: none"> Setting range: 0 to 200 minutes <p>Available when  14 (Loop break alarm output) is selected in [Event output EV□ allocation].</p>
	<p>Loop break alarm span</p> <ul style="list-style-type: none"> Sets the action span to assess the Loop break alarm. Setting range: Thermocouple, RTD input without decimal point: 0 to 150°C (°F) Thermocouple, RTD input with decimal point: 0.0 to 150.0°C (°F) DC voltage, current inputs: 0 to 1500 (The placement of the decimal point follows the selection.) <p>Available when  14 (Loop break alarm output) is selected in [Event output EV□ allocation].</p>

At this stage, settings for Control parameter setting mode are complete.

Press the  key. The unit reverts to RUN mode.

8.4 Setting Items in Wait Parameter Setting Mode

In Wait parameter setting mode, the following setting items can be set:

Wait value, Wait function Enabled/Disabled for each step

Settings are performed for the pattern number selected when entering Wait parameter setting mode.

Setting data is common to all steps in each pattern.

During program control RUN, only the performing pattern can be set.

If 'Pattern link Enabled' is selected in [Pattern link]: Even if the performing pattern is changed from 1 to 2 during Wait parameter setting mode, Pattern 1 will be remained, and the pattern number will not be updated until the unit reverts to RUN mode.

• Wait function

During program control RUN, the program does not proceed to the next step until the deviation between PV and SV enters $SV \pm \text{Wait value}$ at the end of step.

The PV Display and PTN/STEP Display flash while the Wait function is activated.

• Explanation of Wait Function

• Program pattern rising step:

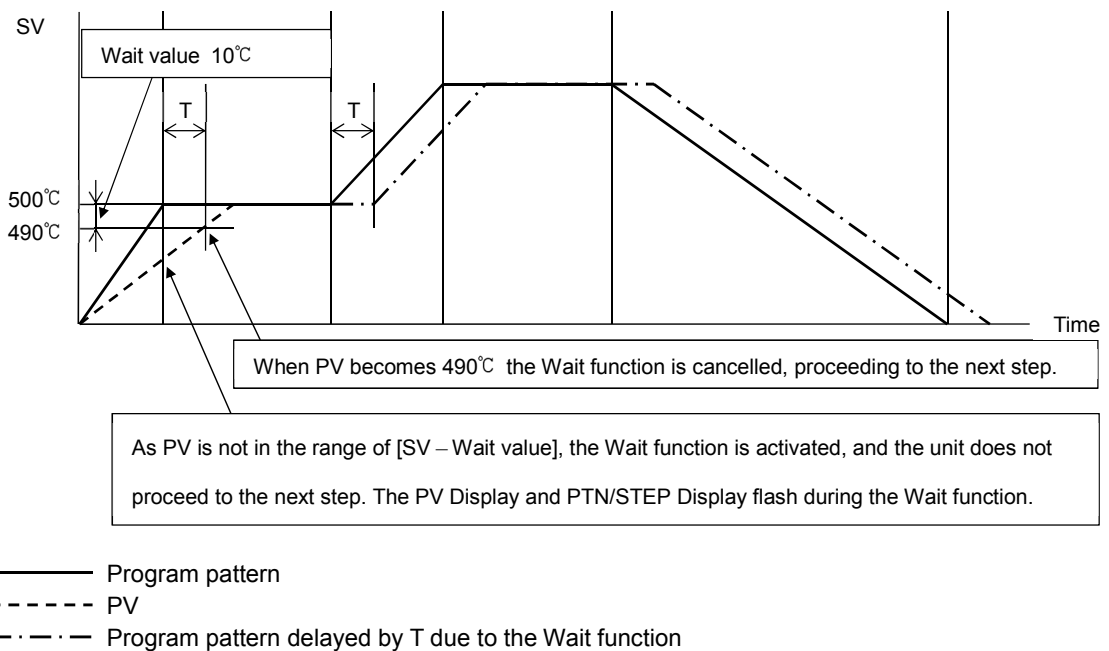

(Fig. 8.4-1)

• Program pattern falling step:

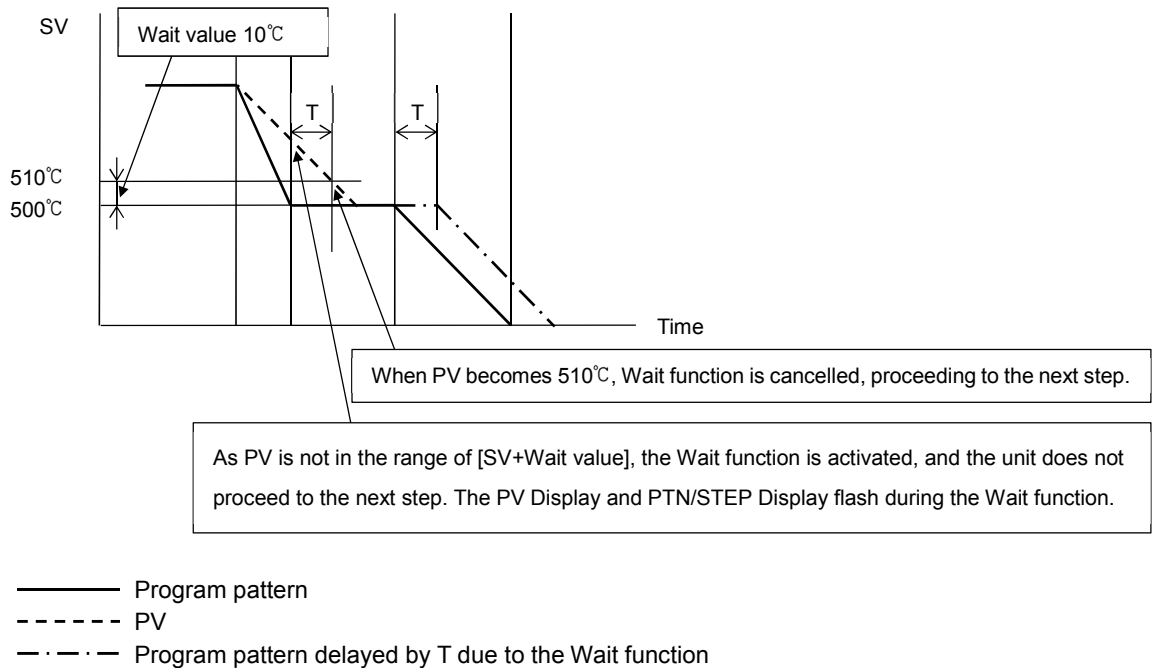

(Fig. 8.4-2)

• How to cancel the Wait function

Press the **RUN** key for approx. 1 second to cancel the Wait function.

• Before entering Wait parameter setting mode

Select a pattern number with the **PTN** key before entering Wait parameter setting mode.

• How to enter Wait parameter setting mode

In RUN mode, press the **▲** and **▼** key (in that order) together for approx. 3 seconds.
The unit enters Wait parameter setting mode.

Setting items in Wait parameter setting mode are shown below.

Characters, Factory Default	Setting Item, Function, Setting Range
	<p>Wait value</p> <ul style="list-style-type: none"> • Sets the Wait value. Wait value is common to all steps for each pattern. When set to 0 or 0.0, the Wait function is disabled. • Setting range: 0 to 20% of input span (*) (*) DC voltage, current inputs: 0 to 20% of scaling span (The placement of the decimal point follows the selection.)

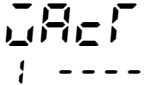
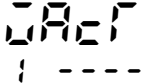
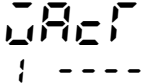
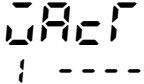
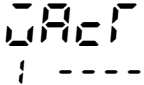
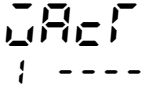
Characters, Factory Default	Setting Item, Function, Setting Range				
 PTN/STEP indicator 1 lights up.	<p>Step 1 wait function Enabled/Disabled</p> <ul style="list-style-type: none"> • Selects the wait function Enabled or Disabled at Step 1, based on the wait value set in [Wait value]. • Selection item: <table border="1" data-bbox="496 443 735 524"> <tr> <td>----</td> <td>Disabled</td> </tr> <tr> <td>USE0</td> <td>Enabled</td> </tr> </table> <p>Not available if wait value is set to 0 or 0.0.</p>	----	Disabled	USE0	Enabled
----	Disabled				
USE0	Enabled				
 PTN/STEP indicator 2 lights up.	<p>Step 2 wait function Enabled/Disabled</p> <ul style="list-style-type: none"> • Selects the wait function Enabled or Disabled at Step 2, based on the wait value set in [Wait value]. • Selection item: <table border="1" data-bbox="496 728 735 808"> <tr> <td>----</td> <td>Disabled</td> </tr> <tr> <td>USE0</td> <td>Enabled</td> </tr> </table> <p>Not available if wait value is set to 0 or 0.0.</p>	----	Disabled	USE0	Enabled
----	Disabled				
USE0	Enabled				
 PTN/STEP indicator 3 lights up.	<p>Step 3 wait function Enabled/Disabled</p> <ul style="list-style-type: none"> • Selects the wait function Enabled or Disabled at Step 3, based on the wait value set in [Wait value]. • Selection item: <table border="1" data-bbox="496 1014 735 1095"> <tr> <td>----</td> <td>Disabled</td> </tr> <tr> <td>USE0</td> <td>Enabled</td> </tr> </table> <p>Not available if wait value is set to 0 or 0.0.</p>	----	Disabled	USE0	Enabled
----	Disabled				
USE0	Enabled				
 PTN/STEP indicator 4 lights up.	<p>Step 4 wait function Enabled/Disabled</p> <ul style="list-style-type: none"> • Selects the wait function Enabled or Disabled at Step 4, based on the wait value set in [Wait value]. • Selection item: <table border="1" data-bbox="496 1301 735 1382"> <tr> <td>----</td> <td>Disabled</td> </tr> <tr> <td>USE0</td> <td>Enabled</td> </tr> </table> <p>Not available if wait value is set to 0 or 0.0.</p>	----	Disabled	USE0	Enabled
----	Disabled				
USE0	Enabled				
 PTN/STEP indicator 5 lights up.	<p>Step 5 wait function Enabled/Disabled</p> <ul style="list-style-type: none"> • Selects the wait function Enabled or Disabled at Step 5, based on the wait value set in [Wait value]. • Selection item: <table border="1" data-bbox="496 1581 735 1662"> <tr> <td>----</td> <td>Disabled</td> </tr> <tr> <td>USE0</td> <td>Enabled</td> </tr> </table> <p>Not available if wait value is set to 0 or 0.0.</p>	----	Disabled	USE0	Enabled
----	Disabled				
USE0	Enabled				
 PTN/STEP indicator 6 lights up.	<p>Step 6 wait function Enabled/Disabled</p> <ul style="list-style-type: none"> • Selects the wait function Enabled or Disabled at Step 6, based on the wait value set in [Wait value]. • Selection item: <table border="1" data-bbox="496 1868 735 1948"> <tr> <td>----</td> <td>Disabled</td> </tr> <tr> <td>USE0</td> <td>Enabled</td> </tr> </table> <p>Not available if wait value is set to 0 or 0.0.</p>	----	Disabled	USE0	Enabled
----	Disabled				
USE0	Enabled				

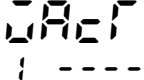
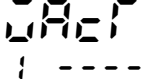
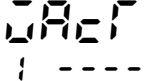
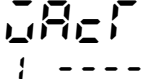
Characters, Factory Default	Setting Item, Function, Setting Range					
 <p>PTN/STEP indicator 7 lights up.</p>	<p>Step 7 wait function Enabled/Disabled</p> <ul style="list-style-type: none"> • Selects the wait function Enabled or Disabled at Step 7, based on the wait value set in [Wait value]. • Selection item: <table border="1" data-bbox="453 398 1479 479"> <tr> <td data-bbox="453 398 608 434">----</td> <td data-bbox="608 398 1479 434">Disabled</td> </tr> <tr> <td data-bbox="453 434 608 479">USE0</td> <td data-bbox="608 434 1479 479">Enabled</td> </tr> </table> <p>Not available if wait value is set to 0 or 0.0.</p>		----	Disabled	USE0	Enabled
----	Disabled					
USE0	Enabled					
 <p>PTN/STEP indicator 8 lights up.</p>	<p>Step 8 wait function Enabled/Disabled</p> <ul style="list-style-type: none"> • Selects the wait function Enabled or Disabled at Step 8, based on the wait value set in [Wait value]. • Selection item: <table border="1" data-bbox="453 680 1479 761"> <tr> <td data-bbox="453 680 608 716">----</td> <td data-bbox="608 680 1479 716">Disabled</td> </tr> <tr> <td data-bbox="453 716 608 761">USE0</td> <td data-bbox="608 716 1479 761">Enabled</td> </tr> </table> <p>Not available if wait value is set to 0 or 0.0.</p>		----	Disabled	USE0	Enabled
----	Disabled					
USE0	Enabled					
 <p>PTN/STEP indicator 9 lights up.</p>	<p>Step 9 wait function Enabled/Disabled</p> <ul style="list-style-type: none"> • Selects the wait function Enabled or Disabled at Step 9, based on the wait value set in [Wait value]. • Selection item: <table border="1" data-bbox="453 965 1479 1046"> <tr> <td data-bbox="453 965 608 1001">----</td> <td data-bbox="608 965 1479 1001">Disabled</td> </tr> <tr> <td data-bbox="453 1001 608 1046">USE0</td> <td data-bbox="608 1001 1479 1046">Enabled</td> </tr> </table> <p>Not available if wait value is set to 0 or 0.0.</p>		----	Disabled	USE0	Enabled
----	Disabled					
USE0	Enabled					
 <p>PTN/STEP indicator 10 lights up.</p>	<p>Step 10 wait function Enabled/Disabled</p> <ul style="list-style-type: none"> • Selects the wait function Enabled or Disabled at Step 10, based on the wait value set in [Wait value]. • Selection item: <table border="1" data-bbox="453 1249 1479 1330"> <tr> <td data-bbox="453 1249 608 1285">----</td> <td data-bbox="608 1249 1479 1285">Disabled</td> </tr> <tr> <td data-bbox="453 1285 608 1330">USE0</td> <td data-bbox="608 1285 1479 1330">Enabled</td> </tr> </table> <p>Not available if wait value is set to 0 or 0.0.</p>		----	Disabled	USE0	Enabled
----	Disabled					
USE0	Enabled					

At this stage, settings for Wait parameter setting mode are complete.

Press the **RST** key. The unit reverts to RUN mode.

8.5 Setting Items in Engineering Setting Mode 1

In Engineering setting mode 1, the following setting items can be set:





Set value lock, Sensor correction, PV filter time constant, Communication parameters (When C5W or C5 option is ordered)

Setting data is common to all patterns.

• How to enter Engineering setting mode 1

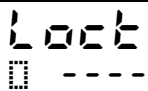
In RUN mode, press the  and **MODE** key (in that order) together for approx. 3 seconds to enter Engineering setting mode 1.

Setting items in Engineering setting mode 1 are shown below.

Characters, Factory Default	Setting Item, Function, Setting Range			
	Set value lock • Locks the set values to prevent setting errors. The setting item to be locked depends on the selection. • Selection item:			
			Change via Keypad	Change via Software Communication
	----	Unlock	All set values can be changed.	All set values can be changed.
	Loc 1	Lock 1	Only 'Set value lock' can be changed. Other setting items cannot be changed.	
	Loc 2	Lock 2	Setting items selected in [Changeable in Set value lock] can be changed. Only 'Set value lock' can be changed.	
	Loc 3	Lock 3	All set values can be changed.	Setting items – except Input type – can be changed temporarily via software communication. However, if power is turned ON again, the set values revert to the values before Lock 3, 4 or 5 was selected.
	Loc 4	Lock 4	Only 'Set value lock' can be changed. Other setting items cannot be changed.	
	Loc 5	Lock 5	Setting items selected in [Changeable in Set value lock] can be changed. Only 'Set value lock' can be changed.	
	Changeable in Set value lock • When Loc 2 (Lock 2) or Loc 5 (Lock 5) is selected in [Set value lock], the following items can be changed. • Selection item:			
		Step SV and Step time can be changed.		
		Step SV, Step time and EV <input type="checkbox"/> alarm value can be changed.		

Characters, Factory Default	Setting Item, Function, Setting Range
Set 0000	<p>Sensor correction coefficient</p> <ul style="list-style-type: none"> Sets sensor correction coefficient. Sets slope of input value from a sensor. <p> $\frac{Y' - X'}{Y - X} = \text{Sensor correction coefficient}$ </p> <p>(Fig. 8.5-1)</p> <p>PV after sensor correction = Current PV x (Sensor correction coefficient) + (Sensor correction value)</p> <p>Refer to Section '9.5 Input Value Correction' (pp.107, 108).</p> <ul style="list-style-type: none"> Setting range: -10.000 to 10.000
Set 0000	<p>Sensor correction</p> <ul style="list-style-type: none"> This corrects the input value from the sensor. <p>When a sensor cannot be set at the exact location where control is desired, the sensor-measured temperature may deviate from the temperature in the controlled location. When using multiple controllers, sometimes the measured temperatures do not concur due to differences in sensor accuracy or dispersion of load capacities. In such a case, the control can be set at the desired temperature by adjusting the input value of sensors.</p> <p>PV after sensor correction = Current PV x (Sensor correction coefficient) + (Sensor correction value)</p> <p>Refer to Section '9.5 Input Value Correction' (pp.107, 108).</p> <ul style="list-style-type: none"> Setting range: -1000.0 to 1000.0°C (°F) <p>DC voltage, current inputs: -10000 to 10000 (The placement of the decimal point follows the selection.)</p>

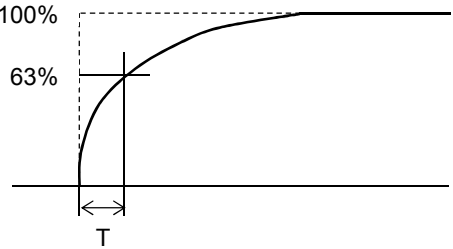
Characters, Factory Default	Setting Item, Function, Setting Range										
F11 0 0000	<p>PV filter time constant</p> <ul style="list-style-type: none"> • Sets PV filter time constant. <p>If the value is set too high, it affects control results due to the delay of response.</p> <p>About PV filter time constant:</p> <p>This is a filter function on the software, which has the same effect as a CR filter. By calculating first-order lag of PV, this suppresses input fluctuation caused by noise.</p> <p>When the input value changes as shown in (Fig. 8.5-2), this function makes the input change slow as shown in (Fig. 8.5-3).</p> <p>T (PV filter time constant) is the time when input change reaches 63% of the desired PV.</p> <div style="text-align: center;">  <p>(Fig. 8.5-2)</p> </div> <div style="text-align: center;">  <p>(Fig. 8.5-3)</p> </div> <ul style="list-style-type: none"> • Setting range: 0.0 to 10.0 seconds 										
C5L 0 noL	<p>Communication protocol</p> <ul style="list-style-type: none"> • Selects communication protocol. • Selection item: <table border="1" data-bbox="459 1541 1481 1749"> <tbody> <tr> <td data-bbox="459 1541 608 1581">noL</td> <td data-bbox="608 1541 1481 1581">Shinko protocol</td> </tr> <tr> <td data-bbox="459 1581 608 1621">S5T</td> <td data-bbox="608 1581 1481 1621">SV digital transmission (Shinko protocol)</td> </tr> <tr> <td data-bbox="459 1621 608 1662">S5r</td> <td data-bbox="608 1621 1481 1662">SV digital reception (Shinko protocol)</td> </tr> <tr> <td data-bbox="459 1662 608 1702">noA</td> <td data-bbox="608 1662 1481 1702">Modbus ASCII mode</td> </tr> <tr> <td data-bbox="459 1702 608 1742">noR</td> <td data-bbox="608 1702 1481 1742">Modbus RTU mode</td> </tr> </tbody> </table> <p>Available when C5W or C5 option is ordered.</p>	noL	Shinko protocol	S5T	SV digital transmission (Shinko protocol)	S5r	SV digital reception (Shinko protocol)	noA	Modbus ASCII mode	noR	Modbus RTU mode
noL	Shinko protocol										
S5T	SV digital transmission (Shinko protocol)										
S5r	SV digital reception (Shinko protocol)										
noA	Modbus ASCII mode										
noR	Modbus RTU mode										
C5O 0 0000	<p>Instrument number</p> <ul style="list-style-type: none"> • Sets the instrument number. <p>The instrument numbers should be set one by one when multiple instruments are connected in Serial communication, otherwise communication is impossible.</p> <ul style="list-style-type: none"> • Setting range: 0 to 95 <p>Available when C5W or C5 option is ordered.</p>										

Characters, Factory Default	Setting Item, Function, Setting Range
C5P 0 0096	Communication speed • Selects a communication speed equal to that of the host computer. • Selection item:
	0096 9600 bps
	0192 19200 bps
	0384 38400 bps
Available when C5W or C5 option is ordered.	
C5P 0 7E8n	Data bit/Parity • Selects data bit and parity equal to those of the host computer. • Selection item:
	8non 8 bits/No parity
	7non 7 bits/No parity
	8E8n 8 bits/Even
	7E8n 7 bits/Even
	8odd 8 bits/Odd
	7odd 7 bits/Odd
Available when C5W or C5 option is ordered.	
C5P 0 0001	Stop bit • Selects the stop bit equal to that of the host computer. • Selection item:
	0001 1 bit
	0002 2 bits
Available when C5W or C5 option is ordered.	
C5D 0 0010	Response delay time • Response from the controller can be delayed after receiving command from the host computer. If Response delay time is changed via software communication, the changed delay time will be reflected from that response data. • Setting range: 0 to 1000 ms Available when C5W or C5 option is ordered.
SV_b 0 0000	SVTC bias • SV adds SVTC bias value to the value received by the SVTC command. • Setting range: $\pm 20\%$ of input span DC voltage, current inputs: $\pm 20\%$ of scaling span (The placement of the decimal point follows the selection.) Available when C5W, C5 option is ordered, and when SV_r [SV digital reception (Shinko protocol)] is selected in [Communication protocol].

At this stage, settings for Engineering setting mode 1 are complete.

Press the **RST** key. The unit reverts to RUN mode.



8.6 Setting Items in Engineering Setting Mode 2

In Engineering setting mode 2, the following setting items can be set:











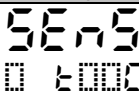













Input type, Scaling high limit, Scaling low limit, Event output EV□ allocation, Step time unit, Power restore action, etc.

Setting data is common to all patterns.

• How to enter Engineering setting mode 2

In RUN mode, press the ,  and **MODE** key (in that order) together for approx. 3 seconds to enter Engineering setting mode 2.

Setting items in Engineering setting mode 2 are shown below.

Characters, Factory Default	Setting Item, Function, Setting Range		
 	Input type		
	<ul style="list-style-type: none"> • Selects an input type from thermocouple (10 types), RTD (2 types), direct current (2 types) and DC voltage (4 type), and the unit °C/°F. • When changing the input from DC voltage to other inputs, remove the sensor connected to this controller first, then change the input. If the input is changed with the sensor connected, the input circuit may break. • When changing an input type, refer to Section “9.6 Items to be Initialized by Changing Settings” (p.109). • Selection item: 		
		K	-200 to 1370 °C
		K	-200.0 to 400.0 °C
		J	-200 to 1000 °C
		R	0 to 1760 °C
		S	0 to 1760 °C
		B	0 to 1820 °C
		E	-200 to 800 °C
		T	-200.0 to 400.0 °C
		N	-200 to 1300 °C
		PL-II	0 to 1390 °C
		C(W/Re5-26)	0 to 2315 °C
		Pt100	-200.0 to 850.0 °C
		JPt100	-200.0 to 500.0 °C
		Pt100	-200 to 850 °C
		JPt100	-200 to 500 °C
		K	-328 to 2498 °F
		K	-328.0 to 752.0 °F
		J	-328 to 1832 °F
		R	32 to 3200 °F
	S	32 to 3200 °F	
	B	32 to 3308 °F	
	E	-328 to 1472 °F	

Characters, Factory Default	Setting Item, Function, Setting Range													
T0.F 0 000	T	-328.0 to 752.0 °F												
n00F	N	-328 to 2372 °F												
PL2F	PL-II	32 to 2534 °F												
c00F	C(W/Re5-26)	32 to 4199 °F												
PT.F	Pt100	-328.0 to 1562.0 °F												
JPTF	JPt100	-328.0 to 932.0 °F												
PT0F	Pt100	-328 to 1562 °F												
JPTF	JPt100	-328 to 932 °F												
420A	4 - 20 mA	-2000 to 10000												
020A	0 - 20 mA	-2000 to 10000												
00.1V	0 - 1 V	-2000 to 10000												
00.5V	0 - 5 V	-2000 to 10000												
1.05V	1 - 5 V	-2000 to 10000												
0.10V	0 - 10 V	-2000 to 10000												
SFLH 0 1370	Scaling high limit <ul style="list-style-type: none"> Sets scaling high limit value. Setting range: Scaling low limit to Input range high limit DC voltage, current inputs: -2000 to 10000 (The placement of the decimal point follows the selection.) 													
SFLL 0 -200	Scaling low limit <ul style="list-style-type: none"> Sets scaling low limit value. Setting range: Input range low limit to Scaling high limit DC voltage, current inputs: -2000 to 10000 (The placement of the decimal point follows the selection.) 													
dP00 0 0000	Decimal point place <ul style="list-style-type: none"> Selects decimal point place. Selection item: <table border="1" style="width: 100%; border-collapse: collapse;"> <tr> <td style="text-align: center;">0000</td> <td>No decimal point</td> </tr> <tr> <td style="text-align: center;">0000</td> <td>1 digit after decimal point</td> </tr> <tr> <td style="text-align: center;">0000</td> <td>2 digits after decimal point</td> </tr> <tr> <td style="text-align: center;">0000</td> <td>3 digits after decimal point</td> </tr> </table> <p style="text-align: center;">Available when DC voltage or current input is selected in [Input type].</p>		0000	No decimal point	0000	1 digit after decimal point	0000	2 digits after decimal point	0000	3 digits after decimal point				
0000	No decimal point													
0000	1 digit after decimal point													
0000	2 digits after decimal point													
0000	3 digits after decimal point													
EV0.1 0 0000	Event output EV1 allocation <ul style="list-style-type: none"> Selects Event output EV1 from the table below. When changing Event output EV1, refer to Section “9.6 Items to be Initialized by Changing Settings” (p.109). Selection item: <table border="1" style="width: 100%; border-collapse: collapse;"> <tr> <td style="text-align: center;">0000</td> <td>No event</td> </tr> <tr> <td style="text-align: center;">0001</td> <td>Alarm output, High limit alarm</td> </tr> <tr> <td style="text-align: center;">0002</td> <td>Alarm output, Low limit alarm</td> </tr> <tr> <td style="text-align: center;">0003</td> <td>Alarm output, High/Low limits alarm</td> </tr> <tr> <td style="text-align: center;">0004</td> <td>Alarm output, High/Low limits independent alarm</td> </tr> <tr> <td style="text-align: center;">0005</td> <td>Alarm output, High/Low limit range alarm</td> </tr> </table> 		0000	No event	0001	Alarm output, High limit alarm	0002	Alarm output, Low limit alarm	0003	Alarm output, High/Low limits alarm	0004	Alarm output, High/Low limits independent alarm	0005	Alarm output, High/Low limit range alarm
0000	No event													
0001	Alarm output, High limit alarm													
0002	Alarm output, Low limit alarm													
0003	Alarm output, High/Low limits alarm													
0004	Alarm output, High/Low limits independent alarm													
0005	Alarm output, High/Low limit range alarm													

Characters, Factory Default	Setting Item, Function, Setting Range	
	0006	Alarm output, High/Low limit range independent alarm
	0007	Alarm output, Process high alarm
	0008	Alarm output, Process low alarm
	0009	Alarm output, High limit with standby alarm
	0010	Alarm output, Low limit with standby alarm
	0011	Alarm output, High/Low limits with standby alarm
	0012	Alarm output, High/Low limits with standby independent alarm
	0013	<p>Heater burnout alarm output (When C5W, EIW or W option is ordered):</p> <p>Detects load current value with CT (current transformer), and if it is lower than heater burnout alarm value, Heater burnout alarm output is turned ON.</p>
	0014	<p>Loop break alarm output:</p> <p>Sets Loop break alarm time and span.</p> <p>• About the Loop break alarm:</p> <p>When the control action is Reverse (Heating) control:</p> <p>If the PV does not reach the Loop break alarm span setting within the time allotted to assess the Loop break alarm (after the MV has reached 100% or the OUT1 high limit value), the alarm output will be turned ON.</p> <p>Likewise, if the PV does not drop to the Loop break alarm span setting within the time allotted to assess the Loop break alarm (after the MV has reached 0% or the OUT1 low limit value), the alarm output will be turned ON.</p> <p>When the control action is Direct (Cooling) control:</p> <p>If the PV does not drop to the Loop break alarm span setting within the time allotted to assess the Loop break alarm (after the MV has reached 100% or the OUT1 high limit value), the alarm output will be turned ON.</p> <p>Likewise, if the PV does not reach the Loop break alarm span setting within the time allotted to assess the Loop break alarm (after the MV has reached 0% or the OUT1 low limit value), the alarm output will be turned ON.</p> <p>• When EV2 option (If “0020 Heating/Cooling control output” is selected in [Event output EV2 allocation]) is ordered, or DS, DA or EV3D option is ordered.</p> <p>When the control action is Reverse (Heating) control:</p> <p>After OUT1 MV has reached 100% or the OUT1 high limit value, or after OUT2 MV has reached 0% or -(OUT2 low limit value), if the PV does not reach the Loop break alarm span setting within the time allotted to assess the Loop break alarm, the alarm output will be turned ON.</p> <p>Likewise, after OUT1 MV has reached 0% or the OUT1 low limit value, or after OUT2 MV has reached -100% or -(OUT2 high limit value), if the PV does not drop to the Loop break alarm span setting within the time allotted to assess the Loop break alarm, the alarm output will be turned ON.</p>

Characters, Factory Default	Setting Item, Function, Setting Range					
		<p>When the control action is Direct (Cooling) control: After OUT1 MV has reached 100% or the OUT1 high limit value, or after OUT2 MV has reached 0% or -(OUT2 low limit value), if the PV does not drop to the Loop break alarm span setting within the time allotted to assess the Loop break alarm, the alarm output will be turned ON. Likewise, after OUT1 MV has reached 0% or the OUT1 low limit value, or after OUT2 MV has reached -100% or -(OUT2 high limit value), if the PV does not reach the Loop break alarm span setting within the time allotted to assess the Loop break alarm, the alarm output will be turned ON.</p>				
	00 15	<p>Time signal output: Turns ON during program control RUN, by setting Time signal output OFF time and ON time within total time in one pattern.</p>				
	00 16	<p>Output during AT: Turns ON during AT.</p>				
	00 17	<p>Pattern end output: Turns ON when Program control ends, and remains ON during the time set in [Pattern end output time].</p>				
	00 18	<p>Output by communication command: Communication command 8004 B0 EV1 output 0: OFF, 1: ON B1 EV2 output 0: OFF, 1: ON B2 EV3 output 0: OFF, 1: ON</p>				
	00 19	<p>RUN output: Turns ON during program control RUN.</p> <p>When 000 1 (High limit alarm) to 00 12 (High/Low limit with standby independent alarm) or 00 15 (Time signal output) is selected, one output can be set to one event output. When 00 13 (Heater burnout alarm output), 00 14 (Loop break alarm), 00 16 (Output during AT) to 00 19 (RUN output) are selected, each output is common to multiple event outputs.</p>				
<p>A 1EA 0 no00</p>		<p>EV1 alarm value 0 Enabled/Disabled</p> <ul style="list-style-type: none"> • When EV1 alarm value is 0 (zero), alarm action can be Enabled or Disabled. • Selection item: <table border="1" data-bbox="453 1507 608 1592"> <tr> <td data-bbox="453 1507 608 1547">no00</td> <td data-bbox="608 1507 1481 1547">Disabled</td> </tr> <tr> <td data-bbox="453 1547 608 1592">YES0</td> <td data-bbox="608 1547 1481 1592">Enabled</td> </tr> </table> <p>Available when any alarm from 000 1 (High limit alarm) to 00 12 (High/Low limits with standby independent alarm) is selected in [Event output EV1 allocation] - excluding 0007 (Process high alarm) and 0008 (Process low alarm).</p>	no00	Disabled	YES0	Enabled
no00	Disabled					
YES0	Enabled					

Characters, Factory Default	Setting Item, Function, Setting Range				
A 144 0 000	<p>EV1 alarm hysteresis</p> <ul style="list-style-type: none"> • Sets EV1 alarm hysteresis. • Setting range: 0.1 to 1000.0°C (°F), DC voltage, current inputs: 1 to 10000 (The placement of the decimal point follows the selection.) <p>Available when any alarm from 000 1 (High limit alarm) to 00 12 (High/Low limits with standby independent alarm) is selected in [Event output EV1 allocation].</p>				
A 124 0 0000	<p>EV1 alarm delay time</p> <ul style="list-style-type: none"> • Sets EV1 alarm action delay time. <p>When setting time has elapsed after PV enters the alarm output range, the alarm is activated.</p> <ul style="list-style-type: none"> • Setting range: 0 to 10000 seconds <p>Available when any alarm from 000 1 (High limit alarm) to 00 12 (High/Low limits with standby independent alarm) is selected in [Event output EV1 allocation].</p>				
A 12A 0 noNL	<p>EV1 alarm Energized/De-energized</p> <ul style="list-style-type: none"> • Selects Energized/De-energized status for EV1 alarm. <p>When Energized is selected, and Event output EV1 is conductive (ON) while the EV1 indicator is lit. Event output EV1 is not conductive (OFF) while the EV1 indicator is not lit.</p> <p>When De-energized is selected, Event output EV1 not conductive (OFF) while the EV1 indicator is lit. Event output EV1 is conductive (ON) while the EV1 indicator is not lit.</p> <div style="display: flex; justify-content: space-around;"> <div data-bbox="494 1137 877 1467"> <p>High limit alarm (Energized)</p> <p>(Fig. 8.6-1)</p> </div> <div data-bbox="957 1137 1340 1467"> <p>High limit alarm (De-energized)</p> <p>(Fig. 8.6-2)</p> </div> </div> <ul style="list-style-type: none"> • Selection item: <table border="1" data-bbox="462 1626 1481 1713"> <tr> <td data-bbox="462 1626 606 1668">noNL</td> <td data-bbox="606 1626 1481 1668">Energized</td> </tr> <tr> <td data-bbox="462 1668 606 1713">rEES</td> <td data-bbox="606 1668 1481 1713">De-energized</td> </tr> </table>	noNL	Energized	rEES	De-energized
noNL	Energized				
rEES	De-energized				
EV02 0 0000	<p>Event output EV2 allocation</p> <ul style="list-style-type: none"> • Selects Event output EV2 from the table below. • When changing Event output EV2, refer to Section “9.6 Items to be Initialized by Changing Settings” (p.109). • Selection item: <table border="1" data-bbox="462 1982 1481 2078"> <tr> <td data-bbox="462 1982 606 2027">0000</td> <td data-bbox="606 1982 1481 2027">No event</td> </tr> <tr> <td data-bbox="462 2027 606 2078">000 1</td> <td data-bbox="606 2027 1481 2078">Alarm output, High limit alarm</td> </tr> </table> <p>Available when any alarm from 000 1 (High limit alarm) to 00 12 (High/Low limits with standby independent alarm) is selected in [Event output EV1 allocation].</p>	0000	No event	000 1	Alarm output, High limit alarm
0000	No event				
000 1	Alarm output, High limit alarm				

Characters, Factory Default	Setting Item, Function, Setting Range	
	0002	Alarm output, Low limit alarm
	0003	Alarm output, High/Low limits alarm
	0004	Alarm output, High/Low limits independent alarm
	0005	Alarm output, High/Low limit range alarm
	0006	Alarm output, High/Low limit range independent alarm
	0007	Alarm output, Process high alarm
	0008	Alarm output, Process low alarm
	0009	Alarm output, High limit with standby alarm
	0010	Alarm output, Low limit with standby alarm
	0011	Alarm output, High/Low limits with standby alarm
	0012	Alarm output, High/Low limits with standby independent alarm
	0013	<p>Heater burnout alarm output (When C5W, EIW or W option is ordered):</p> <p>Detects load current value with CT (current transformer), and if it is lower than heater burnout alarm value, Heater burnout alarm output is turned ON.</p>
	0014	<p>Loop break alarm output:</p> <p>Sets Loop break alarm time and span.</p> <p>• About the Loop break alarm:</p> <p>When the control action is Reverse (Heating) control:</p> <p>If the PV does not reach the Loop break alarm span setting within the time allotted to assess the Loop break alarm (after the MV has reached 100% or the OUT1 high limit value), the alarm output will be turned ON.</p> <p>Likewise, if the PV does not drop to the Loop break alarm span setting within the time allotted to assess the Loop break alarm (after the MV has reached 0% or the OUT1 low limit value), the alarm output will be turned ON.</p> <p>When the control action is Direct (Cooling) control:</p> <p>If the PV does not drop to the Loop break alarm span setting within the time allotted to assess the Loop break alarm (after the MV has reached 100% or the OUT1 high limit value), the alarm output will be turned ON.</p> <p>Likewise, if the PV does not reach the Loop break alarm span setting within the time allotted to assess the Loop break alarm (after the MV has reached 0% or the OUT1 low limit value), the alarm output will be turned ON.</p>

Characters, Factory Default	Setting Item, Function, Setting Range
	<p>• When EV2 option (If “0020 Heating/Cooling control output” is selected in [Event output EV2 allocation]) is ordered, or DS, DA or EV3D□ option is ordered.</p> <p>When the control action is Reverse (Heating) control: After OUT1 MV has reached 100% or the OUT1 high limit value, or after OUT2 MV has reached 0% or -(OUT2 low limit value), if the PV does not reach the Loop break alarm span setting within the time allotted to assess the Loop break alarm, the alarm output will be turned ON. Likewise, after OUT1 MV has reached 0% or the OUT1 low limit value, or after OUT2 MV has reached -100% or -(OUT2 high limit value), if the PV does not drop to the Loop break alarm span setting within the time allotted to assess the Loop break alarm, the alarm output will be turned ON.</p> <p>When the control action is Direct (Cooling) control: After OUT1 MV has reached 100% or the OUT1 high limit value, or after OUT2 MV has reached 0% or -(OUT2 low limit value), if the PV does not drop to the Loop break alarm span setting within the time allotted to assess the Loop break alarm, the alarm output will be turned ON. Likewise, after OUT1 MV has reached 0% or the OUT1 low limit value, or after OUT2 MV has reached -100% or -(OUT2 high limit value), if the PV does not reach the Loop break alarm span setting within the time allotted to assess the Loop break alarm, the alarm output will be turned ON.</p>
0015	Time signal output: Turns ON during program control RUN, by setting Time signal output OFF time and ON time within total time in one pattern.
0016	Output during AT: Turns ON during AT.
0017	Pattern end output: Turns ON when Program control ends, and remains ON during the time set in [Pattern end output time].
0018	Output by communication command: Communication command 8004 B0 EV1 output 0: OFF, 1: ON B1 EV2 output 0: OFF, 1: ON B2 EV3 output 0: OFF, 1: ON
0019	RUN output Turns ON during program control RUN.
0020	Heating/Cooling control Relay contact output Works as Heating/Cooling control output OUT2.
	<p>When 0001 (High limit alarm) to 0012 (High/Low limit with standby independent alarm) or 0015 (Time signal output) is selected, one output can be set to one event output.</p> <p>When 0013 (Heater burnout alarm output), 0014 (Loop break alarm), 0016 (Output during AT) to 0019 (RUN output) are selected, each output is common to multiple event outputs.</p> <p>Available when the EV2 or EV3(DR) option is ordered.</p>

Characters, Factory Default	Setting Item, Function, Setting Range				
A2EA 0 no00	<p>EV2 alarm value 0 Enabled/Disabled</p> <ul style="list-style-type: none"> When EV2 alarm value is 0 (zero), alarm action can be Enabled or Disabled. Selection item: <table border="1" style="width: 100%; border-collapse: collapse;"> <tr> <td style="text-align: center;">no00</td> <td style="text-align: center;">Disabled</td> </tr> <tr> <td style="text-align: center;">YES0</td> <td style="text-align: center;">Enabled</td> </tr> </table> <p>Available when any alarm from 000 1 (High limit alarm) to 00 12 (High/Low limits with standby independent alarm) is selected in [Event output EV2 allocation] - excluding 0007 (Process high alarm) and 0008 (Process low alarm).</p>	no00	Disabled	YES0	Enabled
no00	Disabled				
YES0	Enabled				
A2HY 0 00 0	<p>EV2 alarm hysteresis</p> <ul style="list-style-type: none"> Sets EV2 alarm hysteresis. Setting range: 0.1 to 1000.0°C (°F), DC voltage, current inputs: 1 to 10000 (The placement of the decimal point follows the selection.) <p>Available when any alarm from 000 1 (High limit alarm) to 00 12 (High/Low limits with standby independent alarm) is selected in [Event output EV2 allocation].</p>				
A2DY 0 0000	<p>EV2 alarm delay time</p> <ul style="list-style-type: none"> Sets EV2 alarm action delay time. When setting time has elapsed after PV enters the alarm output range, the alarm is activated. Setting range: 0 to 10000 seconds <p>Available when any alarm from 000 1 (High limit alarm) to 00 12 (High/Low limits with standby independent alarm) is selected in [Event output EV2 allocation].</p>				
A2LA 0 no0L	<p>EV2 alarm Energized/De-energized</p> <ul style="list-style-type: none"> Selects Energized/De-energized status for EV2 alarm. <p>When Energized is selected, and Event output EV2 is conductive (ON) while the EV2 indicator is lit. Event output EV2 is not conductive (OFF) while the EV2 indicator is not lit.</p> <p>When De-energized is selected, Event output EV2 not conductive (OFF) while the EV2 indicator is lit. Event output EV2 is conductive (ON) while the EV2 indicator is not lit.</p> <div style="display: flex; justify-content: space-around; align-items: flex-start;"> <div style="text-align: center;"> <p>High limit alarm (Energized)</p> <p>(Fig. 8.6-3)</p> </div> <div style="text-align: center;"> <p>High limit alarm (De-energized)</p> <p>(Fig. 8.6-4)</p> </div> </div> <ul style="list-style-type: none"> Selection item: <table border="1" style="width: 100%; border-collapse: collapse;"> <tr> <td style="text-align: center;">no0L</td> <td style="text-align: center;">Energized</td> </tr> <tr> <td style="text-align: center;">rEB5</td> <td style="text-align: center;">De-energized</td> </tr> </table> <p>Available when any alarm from 000 1 (High limit alarm) to 00 12 (High/Low limits with standby independent alarm) is selected in [Event output EV2 allocation].</p>	no0L	Energized	rEB5	De-energized
no0L	Energized				
rEB5	De-energized				

Characters, Factory Default	Setting Item, Function, Setting Range
EV3 0 0000	Event output EV3 allocation <ul style="list-style-type: none"> • Selects Event output EV3 from the table below. • When changing Event output EV3, refer to Section “9.6 Items to be Initialized by Changing Settings” (p.109). • Selection item:
0000	No event
0001	Alarm output, High limit alarm
0002	Alarm output, Low limit alarm
0003	Alarm output, High/Low limits alarm
0004	Alarm output, High/Low limits independent alarm
0005	Alarm output, High/Low limit range alarm
0006	Alarm output, High/Low limit range independent alarm
0007	Alarm output, Process high alarm
0008	Alarm output, Process low alarm
0009	Alarm output, High limit with standby alarm
0010	Alarm output, Low limit with standby alarm
0011	Alarm output, High/Low limits with standby alarm
0012	Alarm output, High/Low limits with standby independent alarm
0013	Heater burnout alarm output (When C5W, EIW or W option is ordered): Detects load current value with CT (current transformer), and if it is lower than heater burnout alarm value, Heater burnout alarm output is turned ON.
0014	Loop break alarm output: Sets Loop break alarm time and span. • About the Loop break alarm: When the control action is Reverse (Heating) control: If the PV does not reach the Loop break alarm span setting within the time allotted to assess the Loop break alarm (after the MV has reached 100% or the OUT1 high limit value), the alarm output will be turned ON. Likewise, if the PV does not drop to the Loop break alarm span setting within the time allotted to assess the Loop break alarm (after the MV has reached 0% or the OUT1 low limit value), the alarm output will be turned ON. When the control action is Direct (Cooling) control: If the PV does not drop to the Loop break alarm span setting within the time allotted to assess the Loop break alarm (after the MV has reached 100% or the OUT1 high limit value), the alarm output will be turned ON. Likewise, if the PV does not reach the Loop break alarm span setting within the time allotted to assess the Loop break alarm (after the MV has reached 0% or the OUT1 low limit value), the alarm output will be turned ON.

Characters, Factory Default	Setting Item, Function, Setting Range
	<p>00 14</p> <ul style="list-style-type: none"> • When EV2 option (If “0020 Heating/Cooling control output” is selected in [Event output EV2 allocation]) is ordered, or DS, DA or EV3D□ option is ordered. <p>When the control action is Reverse (Heating) control: After OUT1 MV has reached 100% or the OUT1 high limit value, or after OUT2 MV has reached 0% or -(OUT2 low limit value), if the PV does not reach the Loop break alarm span setting within the time allotted to assess the Loop break alarm, the alarm output will be turned ON. Likewise, after OUT1 MV has reached 0% or the OUT1 low limit value, or after OUT2 MV has reached -100% or -(OUT2 high limit value), if the PV does not drop to the Loop break alarm span setting within the time allotted to assess the Loop break alarm, the alarm output will be turned ON.</p> <p>When the control action is Direct (Cooling) control: After OUT1 MV has reached 100% or the OUT1 high limit value, or after OUT2 MV has reached 0% or -(OUT2 low limit value), if the PV does not drop to the Loop break alarm span setting within the time allotted to assess the Loop break alarm, the alarm output will be turned ON. Likewise, after OUT1 MV has reached 0% or the OUT1 low limit value, or after OUT2 MV has reached -100% or -(OUT2 high limit value), if the PV does not reach the Loop break alarm span setting within the time allotted to assess the Loop break alarm, the alarm output will be turned ON.</p>
	<p>00 15 Time signal output: Turns ON during program control RUN, by setting Time signal output OFF time and ON time within total time in one pattern.</p>
	<p>00 16 Output during AT: Turns ON during AT.</p>
	<p>00 17 Pattern end output: Turns ON when Program control ends, and remains ON during the time set in [Pattern end output time].</p>
	<p>00 18 Output by communication command: Communication command 8004 B0 EV1 output 0: OFF, 1: ON B1 EV2 output 0: OFF, 1: ON B2 EV3 output 0: OFF, 1: ON</p>
	<p>00 19 RUN output: Turns ON during program control RUN.</p>
	<p>When 0001 (High limit alarm) to 0012 (High/Low limit with standby independent alarm) or 0015 (Time signal output) is selected, one output can be set to one event output. When 0013 (Heater burnout alarm output), 0014 (Loop break alarm), 0016 (Output during AT) to 0019 (RUN output) are selected, each output is common to multiple event outputs. Available when the EV3D□ or EI option is ordered.</p>

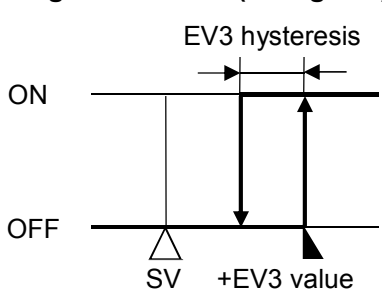
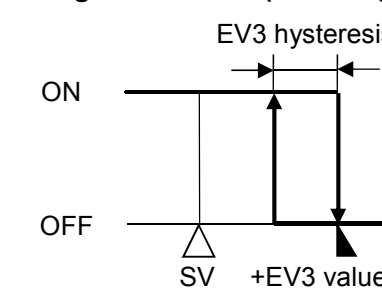
Characters, Factory Default	Setting Item, Function, Setting Range				
A3EA 0 no00	<p>EV3 alarm value 0 Enabled/Disabled</p> <ul style="list-style-type: none"> When EV3 alarm value is 0 (zero), alarm action can be Enabled or Disabled. Selection item: <table border="1" data-bbox="453 309 1481 389"> <tr> <td>no00</td> <td>Disabled</td> </tr> <tr> <td>YES0</td> <td>Enabled</td> </tr> </table> <p>Available when any alarm from 000 1 (High limit alarm) to 00 12 (High/Low limits with standby independent alarm) is selected in [Event output EV3 allocation] - excluding 0007 (Process high alarm) and 0008 (Process low alarm).</p>	no00	Disabled	YES0	Enabled
no00	Disabled				
YES0	Enabled				
A3HY 0 00 0	<p>EV3 alarm hysteresis</p> <ul style="list-style-type: none"> Sets EV3 alarm hysteresis. Setting range: 0.1 to 1000.0°C (°F), DC voltage, current inputs: 1 to 10000 (The placement of the decimal point follows the selection.) <p>Available when any alarm from 000 1 (High limit alarm) to 00 12 (High/Low limits with standby independent alarm) is selected in [Event output EV3 allocation].</p>				
A3DY 0 0000	<p>EV3 alarm delay time</p> <ul style="list-style-type: none"> Sets EV3 alarm action delay time. When setting time has elapsed after PV enters the alarm output range, the alarm is activated. Setting range: 0 to 10000 seconds <p>Available when any alarm from 000 1 (High limit alarm) to 00 12 (High/Low limits with standby independent alarm) is selected in [Event output EV3 allocation].</p>				
A3LA 0 no0L	<p>EV3 alarm Energized/De-energized</p> <ul style="list-style-type: none"> Selects Energized/De-energized status for EV3 alarm. <p>When Energized is selected, and Event output EV3 is conductive (ON) while the EV3 indicator is lit. Event output EV3 is not conductive (OFF) while the EV3 indicator is not lit.</p> <p>When De-energized is selected, Event output EV3 not conductive (OFF) while the EV3 indicator is lit. Event output EV3 is conductive (ON) while the EV3 indicator is not lit.</p> <div style="display: flex; justify-content: space-around;"> <div data-bbox="494 1411 877 1792"> <p>High limit alarm (Energized)</p>  <p>(Fig. 8.6-5)</p> </div> <div data-bbox="925 1411 1308 1792"> <p>High limit alarm (De-energized)</p>  <p>(Fig. 8.6-6)</p> </div> </div> <ul style="list-style-type: none"> Selection item <table border="1" data-bbox="453 1859 1481 1957"> <tr> <td>no0L</td> <td>Energized</td> </tr> <tr> <td>rEV5</td> <td>De-energized</td> </tr> </table> <p>Available when any alarm from 000 1 (High limit alarm) to 00 12 (High/Low limits with standby independent alarm) is selected in [Event output EV3 allocation].</p>	no0L	Energized	rEV5	De-energized
no0L	Energized				
rEV5	De-energized				

Characters, Factory Default	Setting Item, Function, Setting Range																														
EI 1 0 0000	Event input DI1 allocation <ul style="list-style-type: none"> • Selects Event input DI1 from the table below. • Selection item: 																														
	Event input function	Input ON (Closed)	Input OFF (Open)																												
0000	No event																														
0001	Pattern number selection	Refer to "About Event input".																													
0002	Direct/Reverse action	Direct action	Reverse action																												
0003	Program control RUN/STOP	RUN	STOP																												
0004	Program control Holding/Not holding	Holding	Not holding																												
0005	Program control Advance function	Advance function	Usual control																												
Available when C5W, EIW, EIT, C5 or EI option is ordered.																															
<ul style="list-style-type: none"> • About Event input: Signal edge action from OFF to ON / ON to OFF is engaged. However, when power is turned ON, level action is engaged except 0005 (Program control Advance function). If the same item - except 0001 (Pattern number selection) - is selected in [Event input DI1 allocation] and [Event input DI2 allocation], OR calculation [if any one is ON (Closed), the function activates] will begin. An action changed by Event input DI□ has priority. If 0001 (Pattern number selection) is selected, Patterns 1 to 4 can be selected by ON (Closed) or OFF (Open) status of Event input DI1 and DI2. Pattern numbers selected by Event input have priority over pattern numbers selected by keypad operation. To select pattern numbers by keypad operation, make sure all Event inputs are in OFF (Open) status. <p>When 0001 (Pattern number selection) is selected only in [Event input DI1 allocation]</p> <table border="1" style="margin-left: 20px;"> <thead> <tr> <th style="text-align: center;">Pattern number</th> <th style="text-align: center;">*</th> <th style="text-align: center;">2</th> </tr> </thead> <tbody> <tr> <td>Event input DI1</td> <td>OFF(Open)</td> <td>ON(Closed)</td> </tr> </tbody> </table> <p style="margin-left: 20px;">* This number will be selected by keypad.</p> <p>When 0001 (Pattern number selection) is selected only in [Event input DI2 allocation]</p> <table border="1" style="margin-left: 20px;"> <thead> <tr> <th style="text-align: center;">Pattern number</th> <th style="text-align: center;">*</th> <th style="text-align: center;">2</th> </tr> </thead> <tbody> <tr> <td>Event input DI2</td> <td>OFF(Open)</td> <td>ON(Closed)</td> </tr> </tbody> </table> <p style="margin-left: 20px;">* This number will be selected by keypad.</p> <p>When 0001 (Pattern number selection) is selected in [Event input DI1, DI2 allocation]</p> <table border="1" style="margin-left: 20px;"> <thead> <tr> <th style="text-align: center;">Pattern number</th> <th style="text-align: center;">*</th> <th style="text-align: center;">2</th> <th style="text-align: center;">3</th> <th style="text-align: center;">4</th> </tr> </thead> <tbody> <tr> <td>Event input DI1</td> <td>OFF(Open)</td> <td>ON(Closed)</td> <td>OFF(Open)</td> <td>ON(Closed)</td> </tr> <tr> <td>Event input DI2</td> <td>OFF(Open)</td> <td>OFF(Open)</td> <td>ON(Closed)</td> <td>ON(Closed)</td> </tr> </tbody> </table> <p style="margin-left: 20px;">* This number will be selected by keypad.</p>					Pattern number	*	2	Event input DI1	OFF(Open)	ON(Closed)	Pattern number	*	2	Event input DI2	OFF(Open)	ON(Closed)	Pattern number	*	2	3	4	Event input DI1	OFF(Open)	ON(Closed)	OFF(Open)	ON(Closed)	Event input DI2	OFF(Open)	OFF(Open)	ON(Closed)	ON(Closed)
Pattern number	*	2																													
Event input DI1	OFF(Open)	ON(Closed)																													
Pattern number	*	2																													
Event input DI2	OFF(Open)	ON(Closed)																													
Pattern number	*	2	3	4																											
Event input DI1	OFF(Open)	ON(Closed)	OFF(Open)	ON(Closed)																											
Event input DI2	OFF(Open)	OFF(Open)	ON(Closed)	ON(Closed)																											

Characters, Factory Default	Setting Item, Function, Setting Range																														
E1 2 0 0000	Event input DI2 allocation <ul style="list-style-type: none"> • Selects Event input DI2 from the table below. • Selection item: 																														
	Event input function	Input ON (Closed)	Input OFF (Open)																												
0000	No event																														
0001	Pattern number selection	Refer to “About Event input”.																													
0002	Direct/Reverse action	Direct action	Reverse action																												
0003	Program control RUN/STOP	RUN	STOP																												
0004	Program control Holding/Not holding	Holding	Not holding																												
0005	Program control Advance function	Advance function	Usual control																												
Available when C5W, EIW, EIT, C5 or EI option is ordered.																															
<ul style="list-style-type: none"> • About Event input: Signal edge action from OFF to ON / ON to OFF is engaged. However, when power is turned ON, level action is engaged except 0005 (Program control Advance function). If the same item - except 0001 (Pattern number selection) - is selected in [Event input DI1 allocation] and [Event input DI2 allocation], OR calculation [if any one is ON (Closed), the function activates] will begin. An action changed by Event input DI□ has priority. If 0001 (Pattern number selection) is selected, Patterns 1 to 4 can be selected by ON (Closed) or OFF (Open) status of Event input DI1 and DI2. Pattern numbers selected by Event input have priority over pattern numbers selected by keypad operation. To select pattern numbers by keypad, make sure all Event inputs are in OFF (Open) status. <p>When 0001 (Pattern number selection) is selected only in [Event input DI1 allocation]</p> <table border="1" style="margin-left: auto; margin-right: auto;"> <thead> <tr> <th style="text-align: center;">Pattern number</th> <th style="text-align: center;">*</th> <th style="text-align: center;">2</th> </tr> </thead> <tbody> <tr> <td>Event input DI1</td> <td>OFF(Open)</td> <td>ON(Closed)</td> </tr> </tbody> </table> <p style="text-align: center;">* This number will be selected by keypad.</p> <p>When 0001 (Pattern number selection) is selected only in [Event input DI2 allocation]</p> <table border="1" style="margin-left: auto; margin-right: auto;"> <thead> <tr> <th style="text-align: center;">Pattern number</th> <th style="text-align: center;">*</th> <th style="text-align: center;">2</th> </tr> </thead> <tbody> <tr> <td>Event input DI2</td> <td>OFF(Open)</td> <td>ON(Closed)</td> </tr> </tbody> </table> <p style="text-align: center;">* This number will be selected by keypad.</p> <p>When 0001 (Pattern number selection) is selected in [Event input DI1, DI2 allocation]</p> <table border="1" style="margin-left: auto; margin-right: auto;"> <thead> <tr> <th style="text-align: center;">Pattern number</th> <th style="text-align: center;">*</th> <th style="text-align: center;">2</th> <th style="text-align: center;">3</th> <th style="text-align: center;">4</th> </tr> </thead> <tbody> <tr> <td>Event input DI1</td> <td>OFF(Open)</td> <td>ON(Closed)</td> <td>OFF(Open)</td> <td>ON(Closed)</td> </tr> <tr> <td>Event input DI2</td> <td>OFF(Open)</td> <td>OFF(Open)</td> <td>ON(Closed)</td> <td>ON(Closed)</td> </tr> </tbody> </table> <p style="text-align: center;">* This number will be selected by keypad.</p>					Pattern number	*	2	Event input DI1	OFF(Open)	ON(Closed)	Pattern number	*	2	Event input DI2	OFF(Open)	ON(Closed)	Pattern number	*	2	3	4	Event input DI1	OFF(Open)	ON(Closed)	OFF(Open)	ON(Closed)	Event input DI2	OFF(Open)	OFF(Open)	ON(Closed)	ON(Closed)
Pattern number	*	2																													
Event input DI1	OFF(Open)	ON(Closed)																													
Pattern number	*	2																													
Event input DI2	OFF(Open)	ON(Closed)																													
Pattern number	*	2	3	4																											
Event input DI1	OFF(Open)	ON(Closed)	OFF(Open)	ON(Closed)																											
Event input DI2	OFF(Open)	OFF(Open)	ON(Closed)	ON(Closed)																											

Characters, Factory Default	Setting Item, Function, Setting Range						
T-05 0 P800	<p>Transmission output type</p> <ul style="list-style-type: none"> • Selects the transmission output type. Converting the value (PV, SV, MV transmission) to analog signal every 125 ms, outputs the value in current or voltage. • When changing transmission output type, refer to Section “9.6 Items to be Initialized by Changing Settings” (p.109). • Selection item: <table border="1" data-bbox="453 524 1479 651"> <tr> <td>P800</td> <td>PV transmission</td> </tr> <tr> <td>S800</td> <td>SV transmission</td> </tr> <tr> <td>M800</td> <td>MV transmission</td> </tr> </table> <p>Available when EIT option is ordered.</p>	P800	PV transmission	S800	SV transmission	M800	MV transmission
P800	PV transmission						
S800	SV transmission						
M800	MV transmission						
T-LH 0 1370	<p>Transmission output high limit</p> <ul style="list-style-type: none"> • Sets the Transmission output high limit value. (This value corresponds to 20 mA in direct current output.) Outputs Transmission output low limit value if Transmission output high limit and low limit value are the same. If SV or MV transmission is selected, outputs 4 mA at the time of program control STOP (in Standby). • Setting range: PV, SV transmission: Transmission output low limit to Input range high limit Direct current, voltage input: -2000 to 10000 (The placement of the decimal point follows the selection.) MV transmission: Transmission output low limit to 105.0% <p>Available when EIT option is ordered.</p>						
T-LL 0 -200	<p>Transmission output low limit</p> <ul style="list-style-type: none"> • Sets the Transmission output low limit value. (This value corresponds to 4 mA in direct current output.) Outputs Transmission output low limit value if Transmission output high limit and low limit value are the same. If SV or MV transmission is selected, 4 mA is output while in Program control STOP (in Standby). • Setting range: PV, SV transmission: Input range low limit to Transmission output high limit Direct current, voltage input: -2000 to 10000 (The placement of the decimal point follows the selection.) MV transmission: -5.0% to Transmission output high limit <p>Available when EIT option is ordered.</p>						
A-50 0 0000	<p>Step time unit</p> <ul style="list-style-type: none"> • Selects the Step time unit. • Selection item: <table border="1" data-bbox="453 1872 1479 1951"> <tr> <td>0000</td> <td>Hours : Minutes</td> </tr> <tr> <td>SE00</td> <td>Minutes : Seconds</td> </tr> </table>	0000	Hours : Minutes	SE00	Minutes : Seconds		
0000	Hours : Minutes						
SE00	Minutes : Seconds						

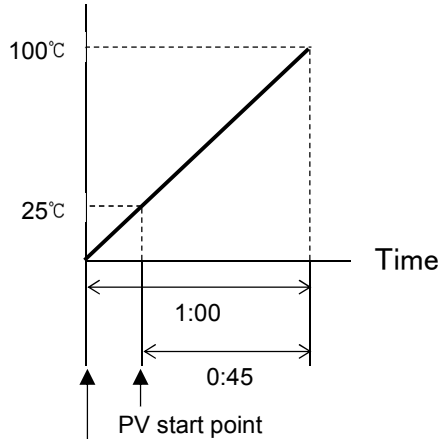
Characters, Factory Default	Setting Item, Function, Setting Range						
P-ET 0 STOP	<p>Power restore action</p> <ul style="list-style-type: none"> • Selects the program status if a power failure occurs mid-program, and it is restored. • Selection item: <table border="1" data-bbox="459 398 1481 875"> <tr> <td data-bbox="459 398 608 517">STOP</td> <td data-bbox="608 398 1481 517"> Stops after power is restored. After power is restored, stops current program control, and returns to the program control STOP (in Standby). </td> </tr> <tr> <td data-bbox="459 517 608 636">CONT</td> <td data-bbox="608 517 1481 636"> Continues (resumes) after power is restored. Continues (resumes) previous program control after power is restored. </td> </tr> <tr> <td data-bbox="459 636 608 875">HOLD</td> <td data-bbox="608 636 1481 875"> Suspends after power is restored. After power is restored, suspends (on hold) current program, and performs Fixed value control using the step SV at the time of suspension. Pressing the RUN key cancels suspension, and program control resumes. </td> </tr> </table>	STOP	Stops after power is restored. After power is restored, stops current program control, and returns to the program control STOP (in Standby).	CONT	Continues (resumes) after power is restored. Continues (resumes) previous program control after power is restored.	HOLD	Suspends after power is restored. After power is restored, suspends (on hold) current program, and performs Fixed value control using the step SV at the time of suspension. Pressing the RUN key cancels suspension, and program control resumes.
STOP	Stops after power is restored. After power is restored, stops current program control, and returns to the program control STOP (in Standby).						
CONT	Continues (resumes) after power is restored. Continues (resumes) previous program control after power is restored.						
HOLD	Suspends after power is restored. After power is restored, suspends (on hold) current program, and performs Fixed value control using the step SV at the time of suspension. Pressing the RUN key cancels suspension, and program control resumes.						
5.54 0 0000	<p>Step SV when program control starts</p> <ul style="list-style-type: none"> • Sets the step SV when Program control starts. • Setting range: Scaling low limit to Scaling high limit (The placement of the decimal point follows the selection.) 						
5.5L 0 P800	<p>Program control start type</p> <ul style="list-style-type: none"> • Selects the Program control start type. • Selection item: <p>PV start, PVR start</p>  <p>When Program control starts, the step SV is advanced to the PV, then Program control starts.</p> <p>(Fig. 8.6-7)</p>						

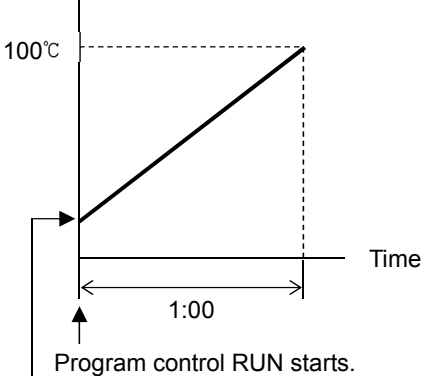
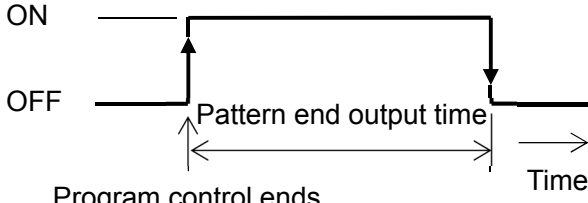
Characters, Factory Default	Setting Item, Function, Setting Range						
	<p>SV start</p>  <p>100°C</p> <p>Time</p> <p>1:00</p> <p>Program control RUN starts.</p> <p>Program control starts from the Step SV set in [Step SV when Program start starts].</p> <p>(Fig. 8.6-8)</p> <ul style="list-style-type: none"> • Selection item: <table border="1" data-bbox="454 840 1489 1234"> <tr> <td data-bbox="454 840 606 952">P800</td> <td data-bbox="606 840 1489 952"> <p>PV start:</p> <p>Only when Program control starts, the step SV and step time are advanced to the PV, then Program control starts.</p> </td> </tr> <tr> <td data-bbox="454 952 606 1108">P8r0</td> <td data-bbox="606 952 1489 1108"> <p>PVR start:</p> <p>When Program control starts and in pattern repeating, the step SV and step time are advanced to the PV, then the Program control starts.</p> </td> </tr> <tr> <td data-bbox="454 1108 606 1234">S800</td> <td data-bbox="606 1108 1489 1234"> <p>SV start:</p> <p>When Program control starts, the Program control starts from the step SV set in [Step SV when program control starts].</p> </td> </tr> </table>	P800	<p>PV start:</p> <p>Only when Program control starts, the step SV and step time are advanced to the PV, then Program control starts.</p>	P8r0	<p>PVR start:</p> <p>When Program control starts and in pattern repeating, the step SV and step time are advanced to the PV, then the Program control starts.</p>	S800	<p>SV start:</p> <p>When Program control starts, the Program control starts from the step SV set in [Step SV when program control starts].</p>
P800	<p>PV start:</p> <p>Only when Program control starts, the step SV and step time are advanced to the PV, then Program control starts.</p>						
P8r0	<p>PVR start:</p> <p>When Program control starts and in pattern repeating, the step SV and step time are advanced to the PV, then the Program control starts.</p>						
S800	<p>SV start:</p> <p>When Program control starts, the Program control starts from the step SV set in [Step SV when program control starts].</p>						
<p>PENd 0 0000</p>	<p>Pattern end output time</p> <ul style="list-style-type: none"> • Sets Pattern end output retention time after program control is finished. <p>If 'Pattern end output' is selected in [Event output EV□ allocation], pattern end output is turned ON after program control is finished, and the SV Display flashes PENd.</p> <p>Setting the time to 0 (zero) seconds causes continuous output, until the STOP key is pressed for 1 second, or until the power is turned OFF.</p> <p>By pressing the STOP key for 1 second, Pattern end output is turned OFF, and the unit returns to program control STOP (in Standby).</p> <p>When setting the time to 1 to 10000 seconds: Pattern end output is automatically turned OFF after Pattern end output time has elapsed, and the unit returns to program control STOP (in Standby).</p>  <p>ON</p> <p>OFF</p> <p>Pattern end output time</p> <p>Time</p> <p>Program control ends</p> <p>(Fig. 8.6-9)</p> <ul style="list-style-type: none"> • Setting range: 0 to 10000 seconds 						

Characters, Factory Default	Setting Item, Function, Setting Range												
AT_b 0 0020	AT bias <ul style="list-style-type: none"> Sets bias value for the AT. AT point is automatically determined by the deviation between PV and SV. AT bias setting works only in Fixed value control. Setting range: Thermocouple, RTD inputs without decimal point: 0 to 50°C (0 to 100°F) Thermocouple, RTD inputs with decimal point: 0.0 to 50.0°C (0.0 to 100.0°F) Available when Thermocouple or RTD input is selected in [Input type]. 												
EoU 0 OFF0	Output status when input errors occur <ul style="list-style-type: none"> Selects the output status when input errors (overscale, underscale) occur. Selection item: <table border="1"> <tr> <td>OFF0</td> <td>Output OFF</td> </tr> <tr> <td>ON00</td> <td>Output ON</td> </tr> </table> <p>Available for direct current and voltage inputs, and direct current output.</p>	OFF0	Output OFF	ON00	Output ON								
OFF0	Output OFF												
ON00	Output ON												
TAE 0 0000	Indication time <ul style="list-style-type: none"> Sets time from no operation status until Displays are switched off. Displays relight by pressing any key while in Display sleep mode. When input errors (overscale, underscale) or burnout has occurred, Displays light up, and error codes are displayed. If errors are cancelled, Displays will turn off after indication time has passed again. Setting range: 00:00 to 60:00 (Minutes : Seconds) When set to 00:00, Displays remain ON. 												
Ed1 F 0 no00	Error indication <ul style="list-style-type: none"> Selects error code indication Enabled/Disabled when input errors occur. When 'Enabled' is selected, error codes below are indicated on the PV Display. <table border="1"> <thead> <tr> <th>Error Code</th> <th>Error Contents</th> </tr> </thead> <tbody> <tr> <td>E-05</td> <td>PV has exceeded Input range high limit value (Scaling high limit value for DC voltage, current inputs).</td> </tr> <tr> <td>E-06</td> <td>PV has dropped below Input range low limit value (Scaling low limit value for DC voltage, current inputs).</td> </tr> <tr> <td>E-07</td> <td>Input burnout, or PV has exceeded, or dropped below the Indication range and Control range. See pages 129, 130.</td> </tr> </tbody> </table> <ul style="list-style-type: none"> Selection item: <table border="1"> <tr> <td>no00</td> <td>Disabled</td> </tr> <tr> <td>YES0</td> <td>Enabled</td> </tr> </table>	Error Code	Error Contents	E-05	PV has exceeded Input range high limit value (Scaling high limit value for DC voltage, current inputs).	E-06	PV has dropped below Input range low limit value (Scaling low limit value for DC voltage, current inputs).	E-07	Input burnout, or PV has exceeded, or dropped below the Indication range and Control range. See pages 129, 130.	no00	Disabled	YES0	Enabled
Error Code	Error Contents												
E-05	PV has exceeded Input range high limit value (Scaling high limit value for DC voltage, current inputs).												
E-06	PV has dropped below Input range low limit value (Scaling low limit value for DC voltage, current inputs).												
E-07	Input burnout, or PV has exceeded, or dropped below the Indication range and Control range. See pages 129, 130.												
no00	Disabled												
YES0	Enabled												

At this stage, settings for Engineering setting mode 2 are complete.

Press the **RST** key. The unit reverts to RUN mode.

8.7 Clearing Data

If data is cleared, all data will revert to factory default values.

Data can be cleared only in program control STOP (in Standby).

Data cannot be cleared during program control RUN.





Caution





Once data clear is executed, initial settings and each setting should be set again.

(Cleared data cannot be restored.)

In preparation for mistaken execution of data clear, please write down initial settings and other setting data in the data sheets at the end of this manual.

• To execute data clear

In RUN mode, and while in program control STOP (in Standby), if the ,  and **STOP** keys (in that order) together are pressed for approx. 3 seconds, the unit enters [Data clear Yes/No].

Characters, Factory Default	Setting Item, Function, Setting Range
	<p>Data clear Yes/No</p> <ul style="list-style-type: none"> Selects if data clear is executed or not. <p>Select 'Data clear No', and press the MODE key. Data will not be cleared, and the unit will return to RUN mode.</p> <p>Select 'Data clear Yes', and press the MODE key. The PV Display indicates  for approx. 3 seconds, and all data will return to factory default values. After that the unit automatically reverts to RUN mode.</p> <ul style="list-style-type: none"> Selection item:
	Data clear No
	Data clear Yes

9. Operation

9.1 Performing Program Control

9.1.1 Performing Program Control

(1) Before turning the power ON

Check Sections “3. Mounting to the Control Panel (pp.12 - 15)” and “4. Wiring (pp.16 - 25)” before turning the power ON.

(2) After turning the power ON

Set necessary setting items after turning the power ON.

Refer to Sections “5. Outline of Key Operation and Each Mode (pp.26 - 28)”, “6. Initial Settings (pp. 29 - 37)”, “7. Basic Settings and Operation (pp.38 - 43)” and “8. Explanation of Setting Items” (pp.44 - 90).

(3) Selecting a pattern number

There are 2 methods for selecting a pattern number:

Using the **PTN** key, or using Event input

Pattern numbers selected by Event input have priority over pattern numbers selected by the keypad.

To select pattern numbers by keypad, make sure all Event inputs are in OFF (Open) status.

- **Using the **PTN** key**

In program control STOP (in Standby), select a pattern from 1 – 10 with the **PTN** key.

- **Using Event input**

If **□□□□** (Pattern number selection) is selected in [Event input DI1 allocation] and [Event input DI2 allocation]:

Select a pattern from 2 – 4, depending on ON (Closed) or OFF (Open) status between Event input DI1/DI2 terminal and SG terminal.

Select pattern 1 or a pattern from 5 – 10 with the **PTN** key.

Signal edge action is engaged. However, when power is turned ON, level action is engaged.

If **□□□□** (Pattern number selection) is selected only in [Event input DI1 allocation]:
(e.g.) To select Pattern 2, close (ON) ⑨ and ⑫.

(Table 9.1.1-1)

Pattern number Terminal number	*	2
⑨ Event input DI1	OFF (Open)	ON (Closed)

* This number will be selected by keypad.

If **□□□□** (Pattern number selection) is selected only in [Event input DI2 allocation]:
(e.g.) To select Pattern 2, close (ON) ⑧ and ⑫.

(Table 9.1.1-2)

Pattern number Terminal number	*	2
⑧ Event input DI2	OFF (Open)	ON (Closed)

* This number will be selected by keypad.

If 0001 (Pattern number selection) is selected in [Event input DI1 allocation] and [Event input DI2 allocation]:

(e.g.) To select Pattern 4, close (ON) ⑨-⑫, and ⑧-⑫.

(Table 9.1.1-3)

Terminal number \ Pattern number	*	2	3	4
⑨ Event input DI1	OFF (Open)	ON (Closed)	OFF (Open)	ON (Closed)
⑧ Event input DI2	OFF (Open)	OFF (Open)	ON (Closed)	ON (Closed)

* This number will be selected by keypad.

(4) Perform Program Control

There are 2 ways to start program control.

Using the **RUN** key, or using Event input.

- **Using the **RUN** key**

In program control STOP (in Standby), press the **RUN** key.

Program control starts.

- **Using Event input**

If 0003 (Program control RUN/STOP) is selected in [Event input DI□ allocation], Program control RUN/STOP can be switched, depending on ON (Closed) or OFF (Open) status between Event input DI1/DI2 terminal and SG terminal.

If 0003 (Program control RUN/STOP) is selected in [Event input DI1 allocation], close (ON) ⑨ and ⑫.

Program control will start.

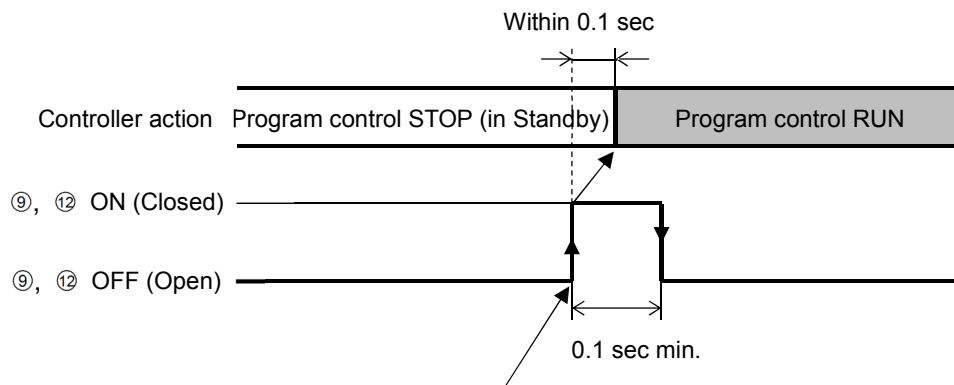

Program control performs by detecting rising signal edge action from OFF (Open) to ON (Closed) of terminals ⑨ and ⑫.

(Fig. 9.1.1-1)

[Program control start type]

Program control start type can be selected in [Program control start type].

PV start:

Only when program control starts, step SV and step time are advanced to the PV, then program control starts.

However, if step SV set in [Step SV when program control starts] is higher than the PV (when PV start is initiated), then program control will start from the SV set in [Step SV when program control starts].

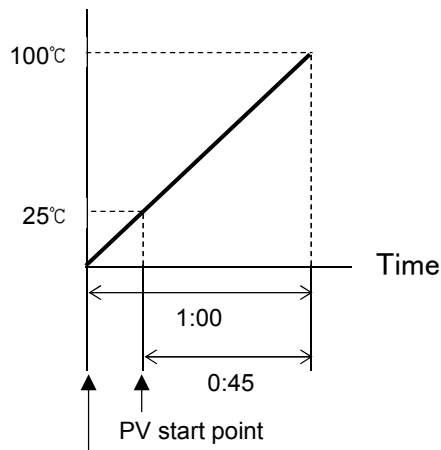

When program control starts,
step SV is advanced to PV (25°C).

(Fig. 9.1.1-2)

PVR start:

When program control starts and in pattern repeating, the step SV and step time are advanced to the PV, then the program control starts.

Action is the same as that of PV start. Refer to (Fig. 9.1.1-2).

SV start:

Program control starts from the value set in [Step SV when program control starts].

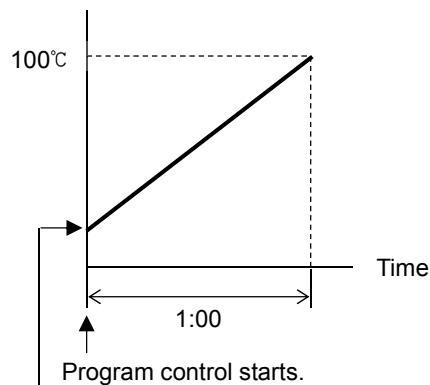

Program control starts from the value set
in [Step SV when program control starts].

(Fig. 9.1.1-3)

[Power Restore Action]

If power fails during program control RUN, the controller can be operated depending on the selection in [Power restore action].

Progressing time error when power is restored: 1 minute or 1 second

- Stops after power is restored:
After power is restored, stops current program control, and returns to program control STOP (in Standby) status.

- Continues after power is restored:
After power is restored, continues (resumes) program control.

- Suspends after power is restored:
After power is restored, suspends (on hold) current program, and performs Fixed value control using the step SV at the time of suspension.
Pressing the **RUN** key cancels suspension, and program control resumes.

[Wait function]

While program control is running, the program does not proceed to the next step until the deviation between PV and SV enters $SV \pm \text{Wait value}$ at the end of step. The PV Display and PTN/STEP Display flash while the Wait function is working.

Explanation of Wait function

• When program pattern is rising:

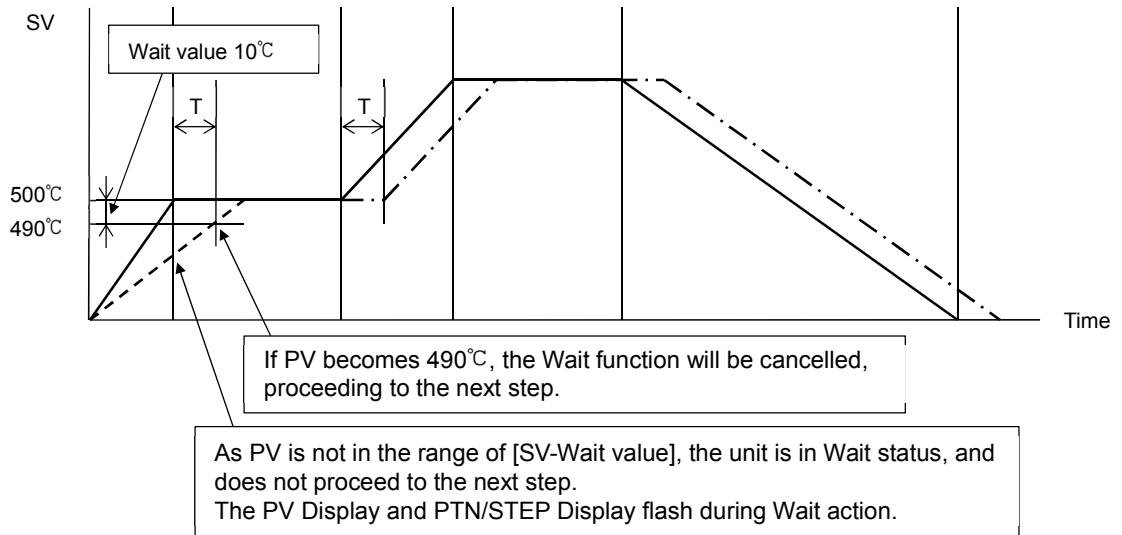

(Fig. 9.1.1-4)

• When program pattern is falling:

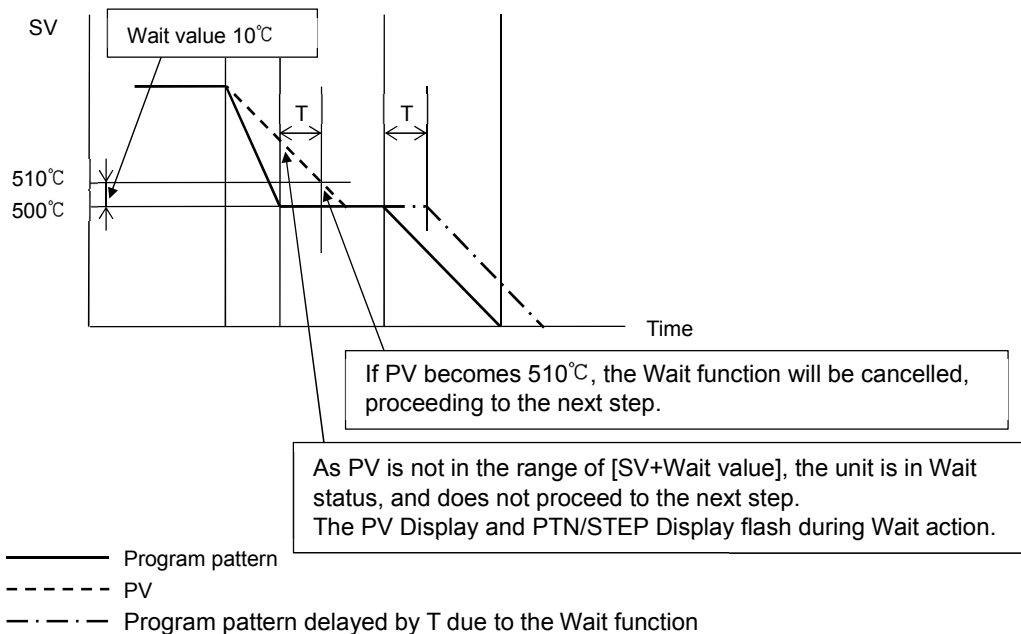

(Fig. 9.1.1-5)

• How to cancel the Wait function

Press the **RUN** key for approx. 1 second to cancel the Wait function.

The Wait function can also be cancelled by selecting **005** (Program control ADVANCE function) in [Event input DI□ allocation], and closing (ON) any terminal of Event input DI□ and SG terminal.

9.1.2 Stopping Program Control

There are 2 methods for stopping program control:

Using the **STOP** key or using Event input

- **Using the **STOP** key**

Press the **STOP** key for approximately 1 second during Program control RUN.

Program control will stop, and revert to program control STOP (in Standby) status.

- **Using Event input**

If **003** (Program control RUN/STOP) is selected in [Event input DI□ allocation],

Program control RUN/STOP can be switched, depending on ON (Closed) or OFF (Open) status between Event input DI□ terminal and SG terminal.

If **003** (Program control RUN/STOP) is selected in [Event input DI1 allocation], open (OFF) ⑨ and ⑫.

Program control will stop, and the unit will revert to program control STOP (in Standby) status.

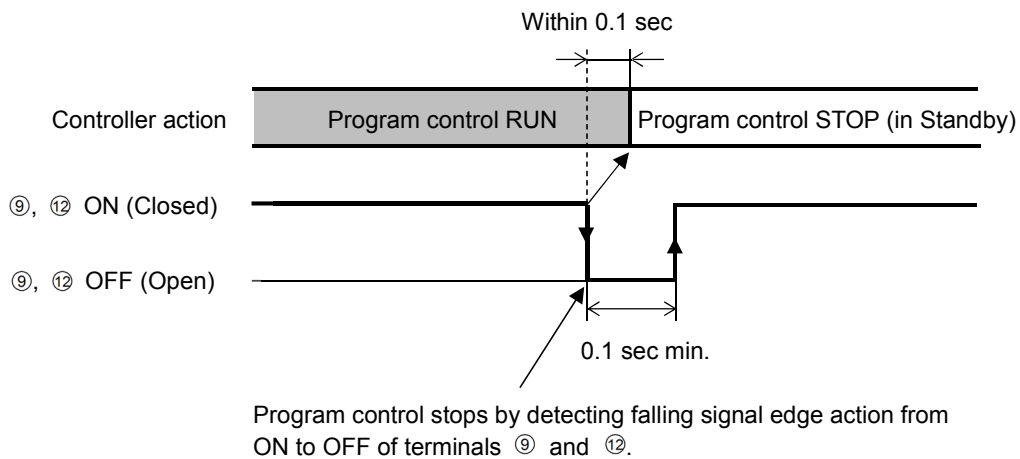

(Fig. 9.1.2-1)

9.1.3 Suspending Program Control (Program Control HOLD Function)

During program control, progress of current step can be suspended (paused). Fixed value control is performed using the step SV at the time of suspension. Pressing the **RUN** key cancels suspension, and program control resumes.

To suspend program control, there are 2 methods:

Using the  key, or using Event input

- **Using the  key**

During program control RUN, press the  key for approx. 1 second.

Progress of current step is suspended, and then Fixed value control is performed using the step SV at the time of suspension.

The PV Display and RUN indicator flash.

- **Using Event input**

If **0004** (Program control Holding/Not holding) is selected in [Event input DI□ allocation], Program control Holding/Not holding can be switched, depending on ON (Closed) or OFF (Open) status between Event input DI□ terminal and SG terminal.

If **0004** (Program control Holding/Not holding) is selected in [Event input DI1 allocation], close (ON) ⑨ and ⑫.

Progress of current step is suspended, and then Fixed value control is performed using the step SV at the time of suspension.

The PV Display and RUN indicator flash.

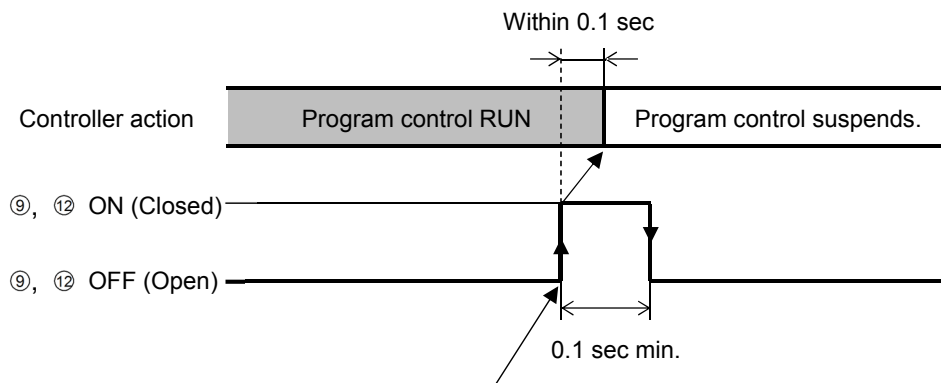

Program control suspends by detecting rising signal edge action from OFF (Open) to ON (Closed) of terminals ⑨ and ⑫.

(Fig. 9.1.3-1)

9.1.4 Advancing Program Step (Advance Function)

Interrupts current step while program control is running, and proceeds to the beginning of the next step.

If the Wait function is working, the Wait function will be cancelled, and will proceed to the beginning of the next step.

To advance program step, there are 2 methods:

Using the **RUN** key, or using Event input

- **Using the **RUN** key**

During program control RUN, press the **RUN** key for approx. 1 second.

Current step is stopped, and the unit proceeds to the beginning of the next step.

Each time the **RUN** key is pressed for approx. 1 second, the unit proceeds to the next step.

- **Using Event input**

If **005** (Program control Advance function) is selected in [Event input DI□ allocation], Program control Advance or usual control can be switched, depending on ON (Closed) or OFF (Open) status between Event input DI□ terminal and SG terminal.

If **005** (Program control Advance function) is selected in [Event input DI1 allocation], close (ON) ⑨ and ⑫.

Current step is stopped, and the unit proceeds to the beginning of the next step.

Each time terminals ⑨ and ⑫ are turned from OFF (Open) to ON (Closed), the unit proceeds to the next step.

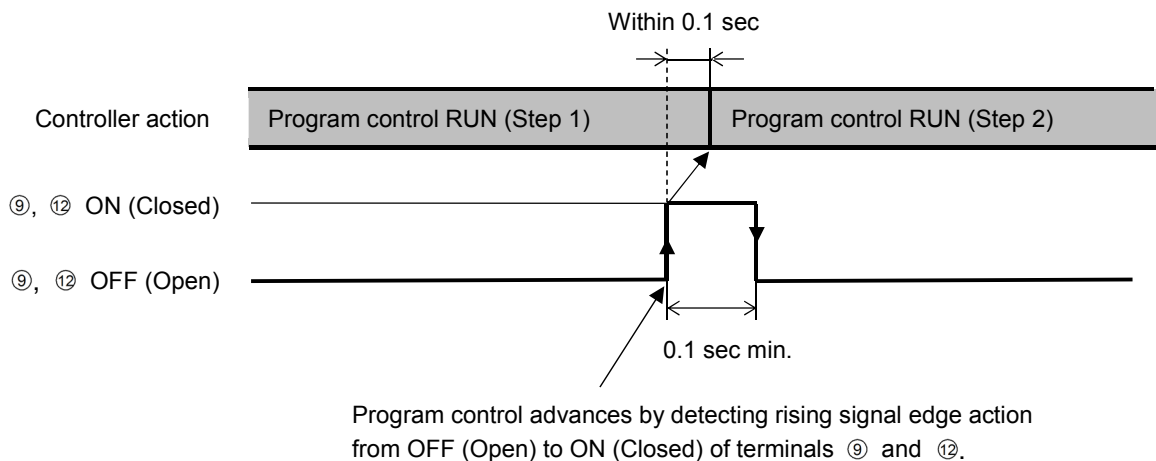

(Fig. 9.1.4-1)

9.1.5 Speeding up Program Step Time (Step Time Speed-up Function)

To make program step time progress faster, press the **FAST** key during program control RUN. While the **FAST** key is pressed, the step time progress is made 60 times faster.

If the Wait function is set, this function will be disabled as the Wait function has priority.

9.1.6 Changing Program Step SV and Step Time

When step SV and step time are changed during program control RUN, they will change as follows.

- When changing step SV from 500 to 700°C

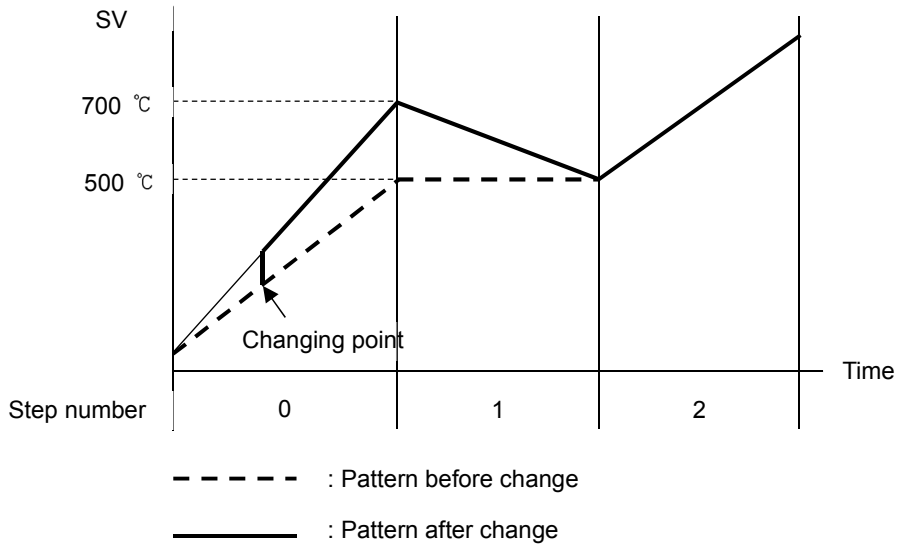

(Fig. 9.1.6-1)

- When changing step time from 0:30 to 0:50

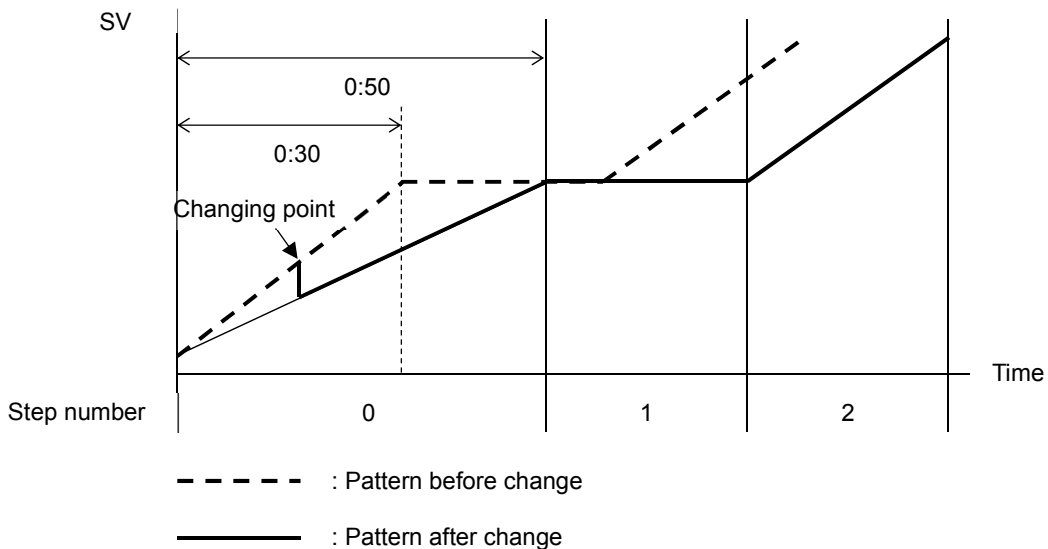

(Fig. 9.1.6-2)

9.1.7 Ending Program (Pattern End Function)

If (Pattern end output) is selected in [Event output EV□ allocation], Pattern end output is turned ON after program control is finished, and the SV Display flashes *PEnd*.

By pressing the **STOP** key for approximately 1 second, Pattern end output is turned OFF, and the unit returns to program control STOP (in Standby).

If Pattern end output time is set, Pattern end output is automatically turned OFF after Pattern end output time has expired. And the unit returns to program control STOP (in Standby).

9.2 Performing Fixed Value Control

9.2.1 Performing Fixed Value Control

Fixed value control (control action that indicating controllers are performing) is performed using the preset step SV.

To perform Fixed value control, set the step time (of the desired step SV) to - - - - .

(e.g.) Set Pattern 1, Step 1 SV to 500°C, and set its step time to - - - - .

Press the **RUN** key. Fixed value control is performed at 500°C.

(1) Before turning the power ON

Check Sections “3. Mounting to the Control Panel (pp.12 - 15)” and “4. Wiring (pp.16 - 25)” before turning the power ON.

(2) After turning the power ON

Set necessary items after turning the power ON.

Refer to Sections “5. Outline of Key Operation and Explanation of Each Mode (pp.26 - 28)”, “6. Initial Settings (pp.29 - 37)”, “7. Basic Settings and Operation (pp.38 - 43)” and “8. Explanation of Setting Items (pp.44 - 90)”.

To perform Fixed value control. set the step SV and step time for the desired pattern.

To set the step time, press the  key at 00:00. - - - - will be selected.

Select a PID block number.

(3) Selecting a pattern number to perform

There are 2 methods for selecting a pattern number:

Using the **PTN** key, or using Event input

Pattern numbers selected by Event input have priority over pattern numbers selected by the **PTN** key.

To select pattern numbers by keypad, make sure all Event inputs are in OFF (Open) status.

• Using the **PTN** key

In program control STOP (in Standby), select a pattern (from 1 – 10) for which step time is set to - - - - at (2), using the **PTN** key.

• Using Event input

If  (Pattern number selection) is selected in [Event input DI□ allocation], select a pattern from 2 – 4, depending on ON (Closed) or OFF (Open) status between Event input DI1/DI2 terminal and SG terminal.

To select Pattern 1 or a pattern from 5 – 10, press the **PTN** key.

Edge action is used. However, when power is turned ON, level action is engaged.

If  (Pattern number selection) is selected only in [Event input DI1 allocation], (e.g.) To select Pattern 2, close (ON) ⑨ and ⑫.

(Table 9.2.1-1)

Pattern number Terminal number	*	2
⑨ Event input DI1	OFF (Open)	ON (Closed)

* This number will be selected by keypad.

If **000** (Pattern number selection) is selected only in [Event input DI2 allocation], (e.g.) To select Pattern 2, close (ON) ⑧ and ⑫.

(Table 9.2.1-2)

Pattern number Terminal number	*	2
⑧ Event input DI2	OFF (Open)	ON (Closed)

* This number will be selected by keypad.

If **000** (Pattern number selection) is selected in [Event input DI1 allocation] and [Event input DI2 allocation]:

(e.g.) To select Pattern 4, close (ON) ⑨-⑫, and ⑧-⑫.

(Table 9.2.1-3)

Pattern number Terminal number	*	2	3	4
⑨ Event input DI1	OFF (Open)	ON (Closed)	OFF (Open)	ON (Closed)
⑧ Event input DI2	OFF (Open)	OFF (Open)	ON (Closed)	ON (Closed)

* This number will be selected by keypad.

(4) Executing Fixed Value Control

There are 2 ways to execute Fixed value control:

Using the **RUN** key, or using Event input

- **Using the **RUN** key.**

In program control STOP (in Standby), press the **RUN** key.

The step, for which step time is set to - - - - at (2), is held, and Fixed value control is performed using the step SV.

The RUN indicator flashes during Fixed value control.

- **Using Event input**

If **003** (Program control RUN/STOP) is selected in [Event input DI□ allocation], Program control RUN/STOP can be switched, depending on ON (Closed) or OFF (Open) status between Event input DI1/DI2 terminal and SG terminal.

If **003** (Program control RUN/STOP) is selected in [Event input DI□ allocation], close (ON) ⑨ and ⑫.

The step, for which step time is set to - - - - at (2), is held, and Fixed value control is performed using the step SV.

The RUN indicator flashes during Fixed value control.

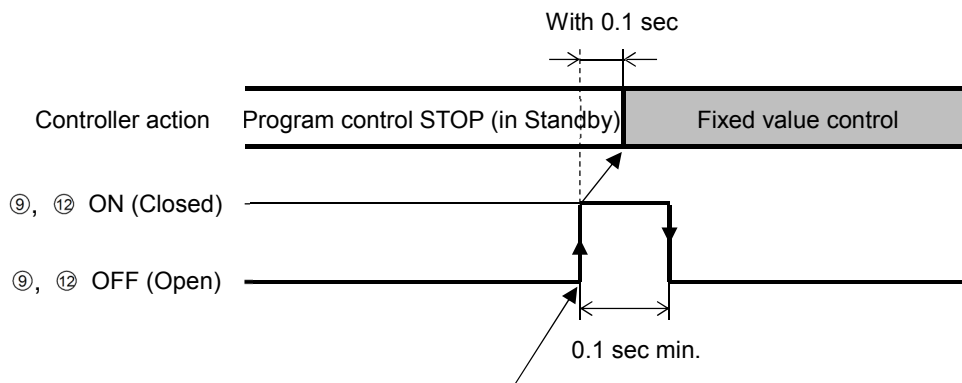

Fixed value control is performed by detecting rising signal edge action from OFF (Open) to ON (Closed) of terminals ⑨ and ⑫.

(Fig. 9.2.1-1)

9.2.2 Finishing Fixed Value Control

There are 2 ways to finish Fixed value control:

Using the **STOP** key, or using Event input

- **Using the **STOP** key**

During Fixed value control, press the **STOP** key for approximately 1 second.

Fixed value control will stop, and the unit will revert to program control STOP (in Standby).

- **Using Event input**

If **003** (Program control RUN/STOP) is selected in [Event input DI□ allocation], Program control RUN/STOP can be switched, depending on ON (Closed) or OFF (Open) status between Event input DI□ terminal and SG terminal.

If **003** (Program control RUN/STOP) is selected in [Event input DI□ allocation], open (OFF) ⑨ and ⑫.

Fixed value control will stop, and the unit will revert to program control STOP (in Standby).

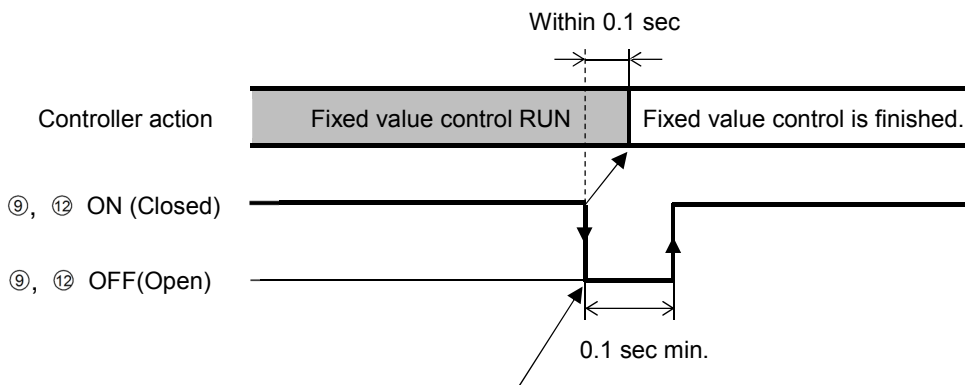

Fixed value control is finished by detecting falling signal edge action from ON (Closed) to OFF (Open) of terminals ⑨ and ⑫.

(Fig. 9.2.2-1)

9.3 Switching Indication of the SV Display

Press the **PTN** key to switch the indication of the SV Display.

Each time the **PTN** key is pressed, switches the indication as follows.

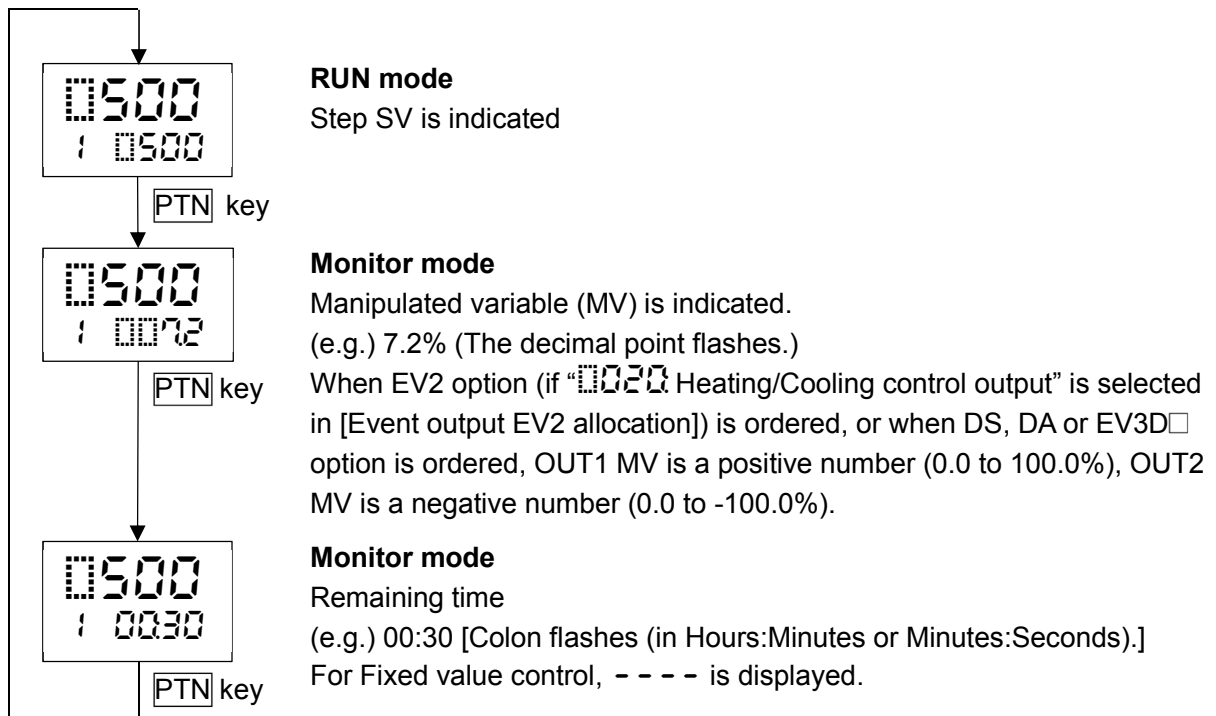

9.4 Performing AT

9.4.1 Notice when Performing AT



Notice

- Perform the AT during the test operation.
- During the AT, none of the setting items can be set.
- If power failure occurs during AT, AT will stop.
- If AT is cancelled during the process, P, I, D and ARW values will revert to the values before AT was performed.
- AT will be forced to stop if it has not been completed within 4 hours.
- Sometimes the AT process will not fluctuate if AT is performed at or near room temperature. Therefore AT might not finish normally.

[Notice when performing AT during Program control RUN]

- If AT is performed, AT starts from the AT starting point, and step time does not progress until AT finishes. After AT finishes, remaining step will be performed.

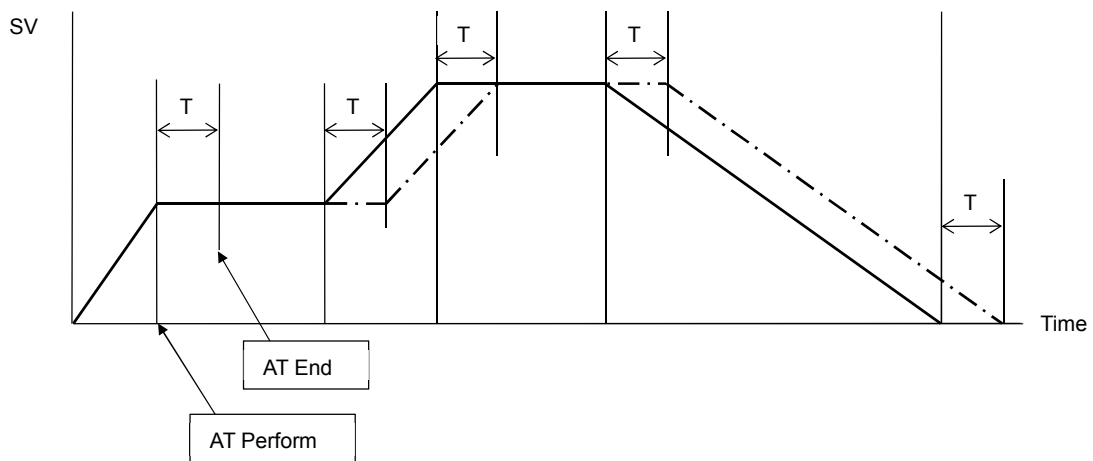

T: Time delay due to AT

———— : Program pattern before AT is performed.

- · - · - · : Program pattern after AT is performed.

(Fig. 9.4.1-1)

9.4.2 AT Action

In order to set each value of P, I, D and ARW automatically, the AT process should be made to fluctuate to obtain an optimal value.

For DC voltage, current inputs, the AT process will fluctuate around the SV for conditions of [A], [B] and [C] below.

One of 3 types of fluctuation below is automatically selected depending on the deviation between SV and PV.

[A] If there is a large difference between the SV and PV as the temperature is rising

When AT bias is set to 20°C, AT process will fluctuate at the temperature 20°C lower than the SV.

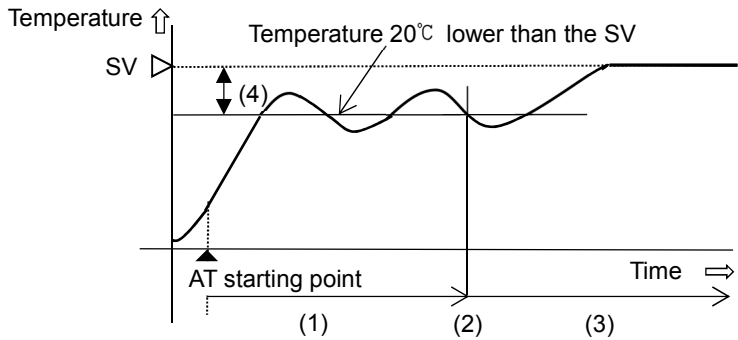

- (1) Calculates PID constants.
- (2) PID constants calculated
- (3) Controlled by the PID constants set by AT
- (4) AT bias value (Factory default: 20°C)

(Fig. 9.4.2-1)

[B] When the control is stable

The AT process will fluctuate around the SV.

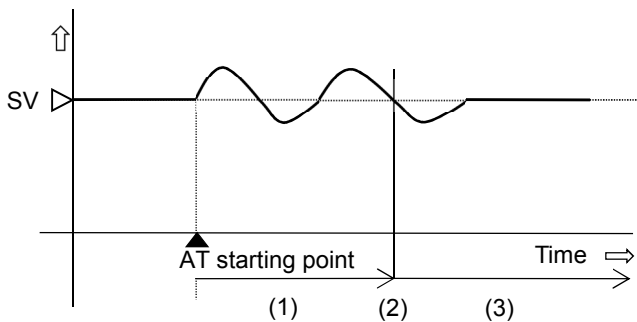

- (1) Calculates PID constants.
- (2) PID constants calculated
- (3) Controlled by the PID constants set by AT

(Fig. 9.4.2-2)

[C] If there is a large difference between the SV and PV as the temperature is falling

When AT bias is set to 20°C, AT process will fluctuate at the temperature 20°C higher than the SV.

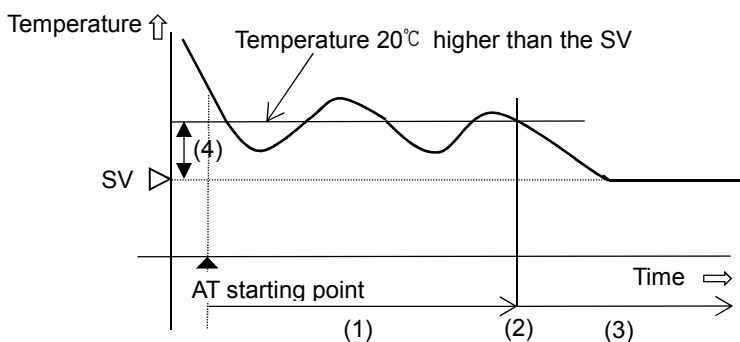

- (1) Calculates PID constants.
- (2) PID constants calculated
- (3) Controlled by the PID constants set by AT
- (4) AT bias value (Factory default: 20°C)

(Fig. 9.4.2-3)

9.4.3 Performing AT

To perform AT, select **AT** (AT Perform) in [AT Perform/Cancel] in Control parameter setting mode. And press the **RST** key.

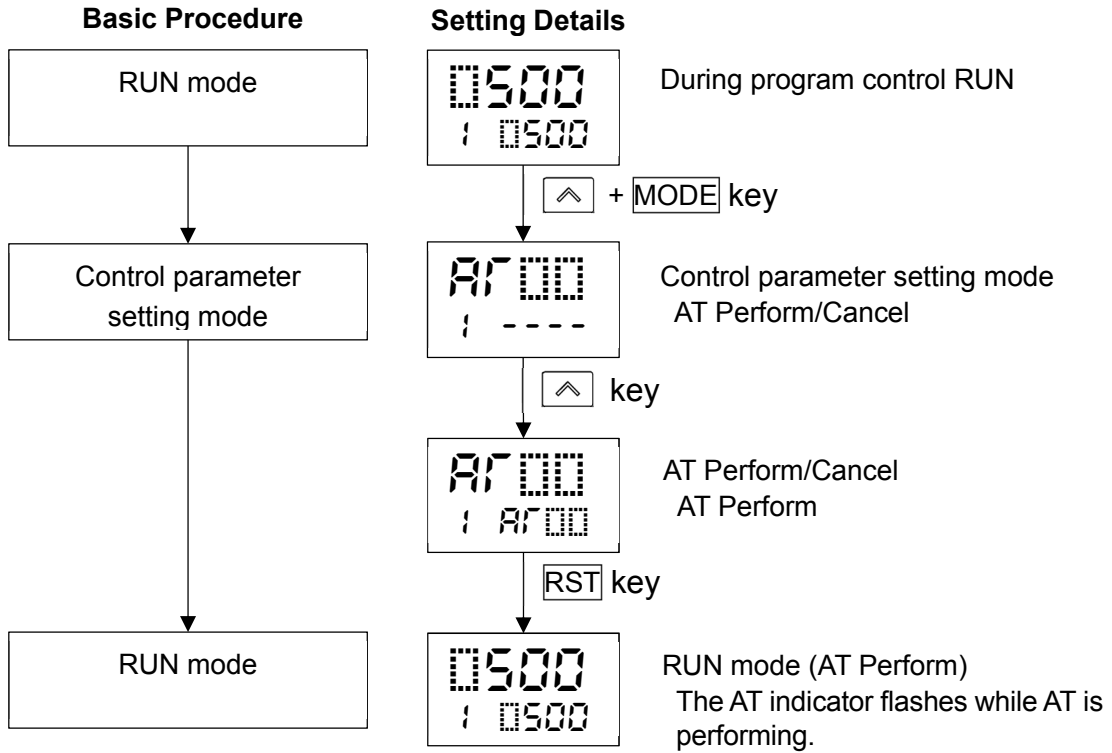

9.5 Input Value Correction

Input value can be corrected in [Sensor correction coefficient] and [Sensor correction] in Engineering setting mode 1.

In [Sensor correction coefficient], set the slope of temperature change.

In [Sensor correction], set the difference between temperatures before correction and after correction.

PV after input correction is expressed by the following formula.

PV after input correction = Current PV x Sensor correction coefficient + (Sensor correction value)

The following shows an example of input value correction using 'Sensor correction coefficient' and 'Sensor correction value'.

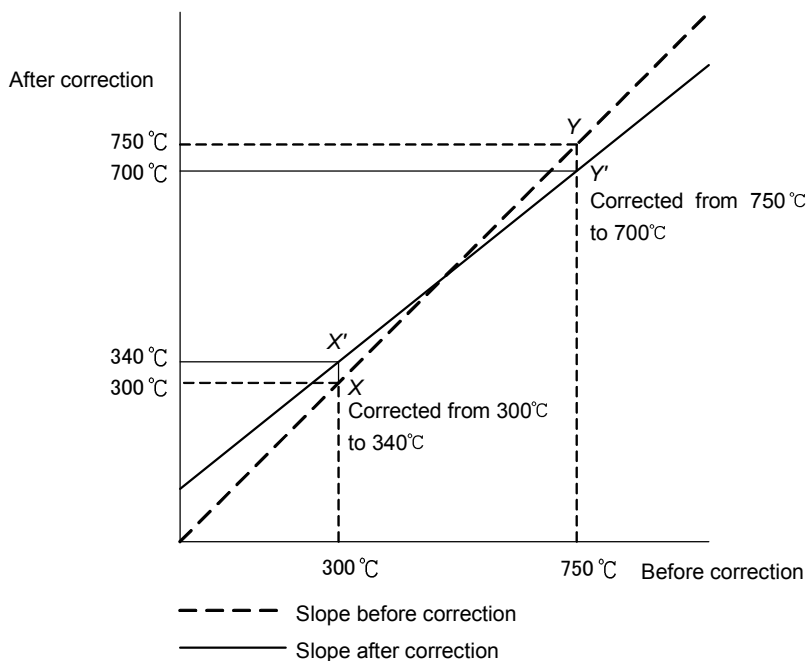

(Fig. 9.5-1)

- (1) Select any 2 points of PV to be corrected, and determine the PV after correction.
 PV before correction: 300°C → PV after correction: 340°C
 PV before correction: 750°C → PV after correction: 700°C
- (2) Calculate Sensor correction coefficient from Step (1).
 $(Y' - X') / (Y - X) = (700 - 340) / (750 - 300) = 0.8$
- (3) Enter a PV value of 300°C using an mV generator or dial resistor.
- (4) Set Step (2) value as a Sensor correction coefficient.
- (5) Read the PV.
 240°C will be indicated.
- (6) Calculate the sensor correction value.
 Calculate the difference between 'PV after correction' and Step (5) PV.
 $340°C - 240°C = 100°C$
- (7) Set Step (6) value as a Sensor correction value.
- (8) Enter an electromotive force or resistance value equivalent to 750°C using an mV generator or dial resistor.
- (9) Read the PV, and confirm that 700°C is indicated.

(Example) Setting Sensor correction coefficient to 0.800, and Sensor correction to 100.0°C

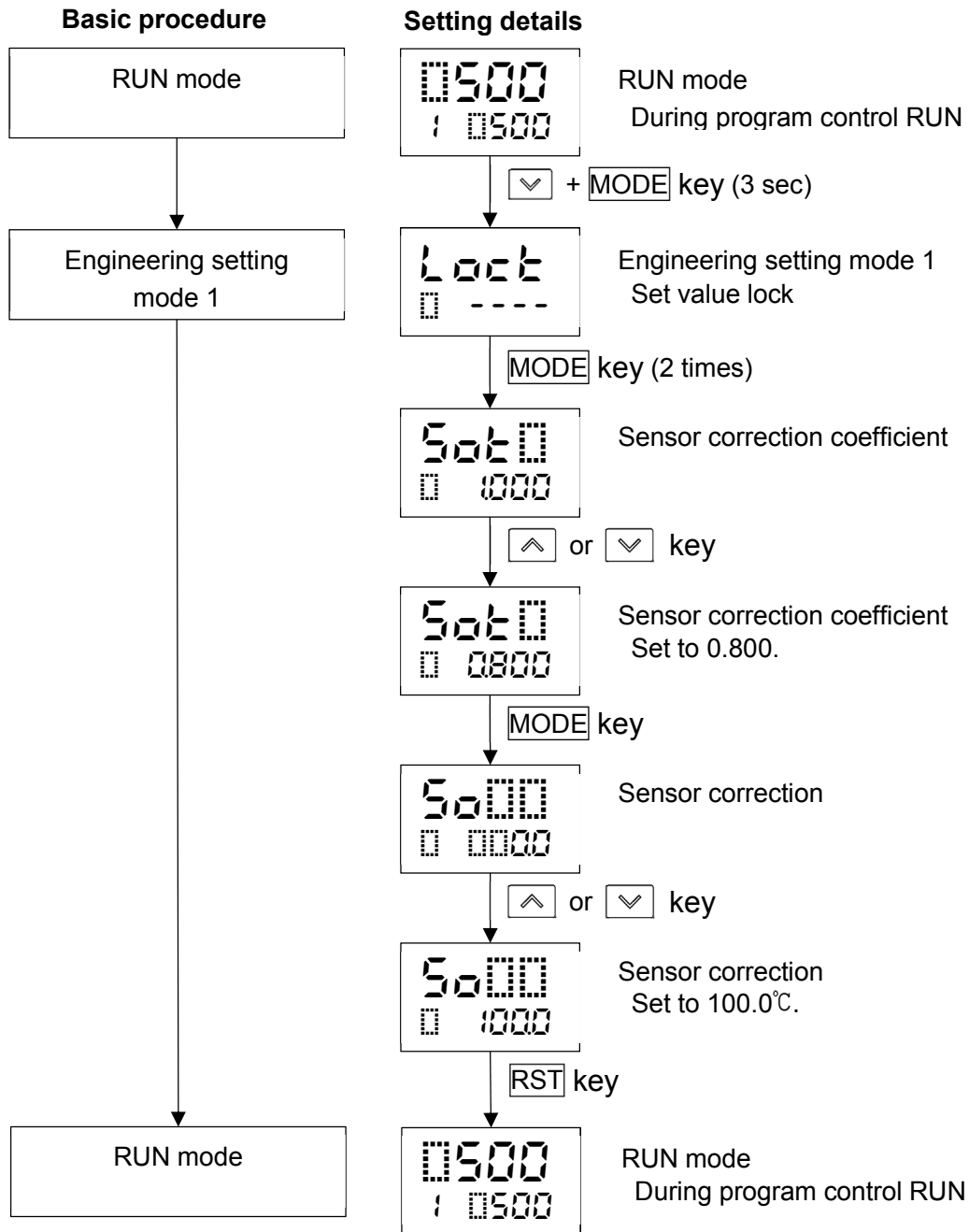

9.6 Items to be Initialized by Changing Settings

If settings are changed, the following items will be initialized.

●: Initialized

x: Not initialized

Setting item to be changed Item to be initialized	Input Type	Event output EV1 allocation	Event output EV2 allocation	Event output EV3 allocation	Transmission output
Loop break alarm time	●	x	x	x	x
Loop break alarm span	●	x	x	x	x
Sensor correction coefficient	●	x	x	x	x
Sensor correction	●	x	x	x	x
SVTC bias	●	x	x	x	x
Scaling high limit	●	x	x	x	x
Scaling low limit	●	x	x	x	x
EV1 alarm value 0 Enabled/Disabled	x	●	x	x	x
EV1 alarm hysteresis	x	●	x	x	x
EV1 alarm delay time	x	●	x	x	x
EV1 alarm Energized/De-energized	x	●	x	x	x
EV2 alarm value 0 Enabled/Disabled	x	x	●	x	x
EV2 alarm hysteresis	x	x	●	x	x
EV2 alarm delay time	x	x	●	x	x
EV2 alarm Energized/De-energized	x	x	●	x	x
EV3 alarm value 0 Enabled/Disabled	x	x	x	●	x
EV3 alarm hysteresis	x	x	x	●	x
EV3 alarm delay time	x	x	x	●	x
EV3 alarm Energized/De-energized	x	x	x	●	x
Transmission output high limit *	●	x	x	x	●
Transmission output low limit *	●	x	x	x	●
Step SV when program control starts	●	x	x	x	x
AT bias	●	x	x	x	x

* When PV transmission or SV transmission is selected, and if input type is changed, these setting items will be initialized.

10. Action Explanation

10.1 OUT1 Action

Action	Reverse (Heating) Action	Direct (Cooling) Action
Control action		
Relay contact output		
Non-contact voltage output		
Direct current output		
Indicator (OUT) Green		

: Turns ON (lit) or OFF (unlit).

10.2 OUT1 ON/OFF Control Action

Action	Reverse (Heating) Action	Direct (Cooling) Action
Control action		
Relay contact output		
Non-contact voltage output		
Direct current output		
Indicator (OUT) Green		

: Turns ON (lit) or OFF (unlit).

10.3 Heater Burnout Alarm Action

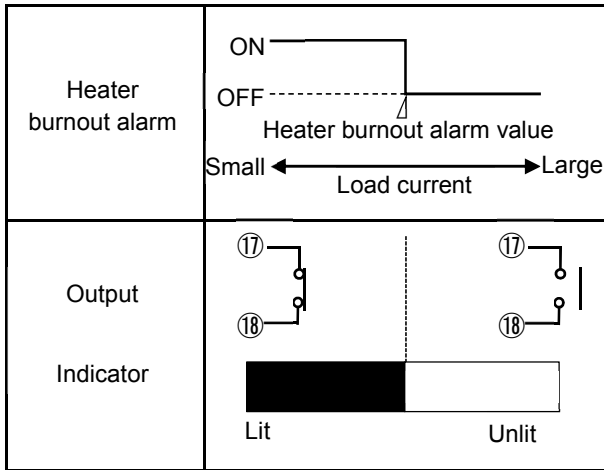

Event output EV1 terminal numbers: 17, 18

Event output EV2 terminal numbers: 19, 20

Event output EV3 terminal numbers: 6, 7

10.4 Alarm Action

	High limit alarm	Low limit alarm
Alarm action	<p>Diagram showing alarm action for a high limit alarm. The process value (PV) is compared to the setpoint (SV). When PV reaches the +EV1 value, the alarm turns ON. When PV returns to the SV, the alarm turns OFF. When PV reaches the -EV1 value, the alarm turns OFF. Hysteresis is shown between the ON and OFF points.</p>	<p>Diagram showing alarm action for a low limit alarm. The process value (PV) is compared to the setpoint (SV). When PV reaches the -EV1 value, the alarm turns ON. When PV returns to the SV, the alarm turns OFF. When PV reaches the +EV1 value, the alarm turns ON. Hysteresis is shown between the ON and OFF points.</p>
Alarm output	<p>Diagram showing alarm output for a high limit alarm. The + side (top bar) is ON (black) when PV is above the +EV1 value. The - side (bottom bar) is ON (black) when PV is below the -EV1 value. Hatched areas indicate the alarm is active during the hysteresis period.</p>	<p>Diagram showing alarm output for a low limit alarm. The + side (top bar) is ON (black) when PV is below the -EV1 value. The - side (bottom bar) is ON (black) when PV is above the +EV1 value. Hatched areas indicate the alarm is active during the hysteresis period.</p>
	High/Low limits alarm	High/Low limits independent alarm
Alarm action	<p>Diagram showing alarm action for a high/low limits alarm. The process value (PV) is compared to the setpoint (SV). When PV reaches the EV1 value, the alarm turns ON. When PV returns to the SV, the alarm turns OFF. When PV reaches the EV1 value, the alarm turns ON. Hysteresis is shown between the ON and OFF points.</p>	<p>Diagram showing alarm action for a high/low limits independent alarm. The process value (PV) is compared to the setpoint (SV). When PV reaches the EV1 low limit value, the alarm turns ON. When PV returns to the SV, the alarm turns OFF. When PV reaches the EV1 high limit value, the alarm turns ON. Hysteresis is shown between the ON and OFF points.</p>
Alarm output	<p>Diagram showing alarm output for a high/low limits alarm. The + side (top bar) is ON (black) when PV is above the EV1 value. The - side (bottom bar) is ON (black) when PV is below the EV1 value. Hatched areas indicate the alarm is active during the hysteresis period.</p>	<p>Diagram showing alarm output for a high/low limits independent alarm. The + side (top bar) is ON (black) when PV is above the EV1 high limit value. The - side (bottom bar) is ON (black) when PV is below the EV1 low limit value. Hatched areas indicate the alarm is active during the hysteresis period.</p>
	High/Low limit range alarm	High/Low limit range independent
Alarm action	<p>Diagram showing alarm action for a high/low limit range alarm. The process value (PV) is compared to the setpoint (SV). When PV reaches the EV1 value, the alarm turns ON. When PV returns to the SV, the alarm turns OFF. When PV reaches the EV1 value, the alarm turns ON. Hysteresis is shown between the ON and OFF points.</p>	<p>Diagram showing alarm action for a high/low limit range independent alarm. The process value (PV) is compared to the setpoint (SV). When PV reaches the EV1 low limit value, the alarm turns ON. When PV returns to the SV, the alarm turns OFF. When PV reaches the EV1 high limit value, the alarm turns ON. Hysteresis is shown between the ON and OFF points.</p>
Alarm output	<p>Diagram showing alarm output for a high/low limit range alarm. The + side (top bar) is ON (black) when PV is above the EV1 value. The - side (bottom bar) is ON (black) when PV is below the EV1 value. Hatched areas indicate the alarm is active during the hysteresis period.</p>	<p>Diagram showing alarm output for a high/low limit range independent alarm. The + side (top bar) is ON (black) when PV is above the EV1 high limit value. The - side (bottom bar) is ON (black) when PV is below the EV1 low limit value. Hatched areas indicate the alarm is active during the hysteresis period.</p>
	Process high alarm	Process low alarm
Alarm action	<p>Diagram showing alarm action for a process high alarm. The process value (PV) is compared to the setpoint (SV). When PV reaches the EV1 value, the alarm turns ON. When PV returns to the SV, the alarm turns OFF. Hysteresis is shown between the ON and OFF points.</p>	<p>Diagram showing alarm action for a process low alarm. The process value (PV) is compared to the setpoint (SV). When PV reaches the EV1 value, the alarm turns ON. When PV returns to the SV, the alarm turns OFF. Hysteresis is shown between the ON and OFF points.</p>
Alarm output	<p>Diagram showing alarm output for a process high alarm. The + side (top bar) is ON (black) when PV is above the EV1 value. The - side (bottom bar) is ON (black) when PV is below the EV1 value. Hatched areas indicate the alarm is active during the hysteresis period.</p>	<p>Diagram showing alarm output for a process low alarm. The + side (top bar) is ON (black) when PV is below the EV1 value. The - side (bottom bar) is ON (black) when PV is above the EV1 value. Hatched areas indicate the alarm is active during the hysteresis period.</p>

	High limit with standby	Low limit with standby alarm
Alarm action		
Alarm output		
	High/Low limits with standby alarm	High/Low limits with standby independent
Alarm action		
Alarm output		

■ : Event output EV1 terminals 17, 18: ON

▨ : Event output EV1 terminals 17, 18: ON or OFF

□ : Event output EV1 terminals 17, 18: OFF

▩ : Alarm output is in standby.

- EV1 value, EV1 high limit value, and EV1 hysteresis represent EV1 alarm value, EV1 high limit alarm value and EV1 alarm hysteresis respectively.
EV1 will be substituted by EV2 or EV3.

- EV1 indicator lights up when Event output EV1 terminals 17 and 18 are ON, and turns off when their output terminals 17 and 18 are OFF.

EV2 indicator lights up when Event output EV2 terminals 19 and 20 are ON, and turns off when their output terminals 19 and 20 are OFF.

EV3 indicator lights up when Event output EV3 terminals 6 and 7 are ON, and turns off when their output terminals 6 and 7 are OFF.

10.5 OUT2 (Heating/Cooling Control) Action

Control action			
Relay contact output (OUT1)	<p>Cycle action is performed according to deviation.</p>		
Non-contact voltage output (OUT1)	<p>Cycle action is performed according to deviation.</p>		
Direct current output (OUT1)	<p>Changes continuously according to deviation.</p>		
Relay contact output (OUT2)	<p>Cycle action is performed according to deviation.</p>		
Non-contact voltage output (OUT2)	<p>Cycle action is performed according to deviation.</p>		
Direct current output (OUT2)	<p>Changes continuously according to deviation.</p>		
Indicator (OUT)	<p>Lit Unlit</p>		
Indicator (EV2)	<p>Unlit Lit</p>		

- : Turns ON (lit) or OFF (unlit).
- : Represents Heating control action.
- : Represents Cooling control action.

10.6 OUT2 (Heating/Cooling Control) Action (When Setting Dead Band)

Control action			
Relay contact output (OUT1)	<p>Cycle action is performed according to deviation.</p>		
Non-contact voltage output (OUT1)	<p>Cycle action is performed according to deviation.</p>		
Direct current output (OUT1)	<p>Changes continuously according to deviation.</p>		
Relay contact output (OUT2)	<p>Cycle action is performed according to deviation.</p>		
Non-contact voltage output (OUT2)	<p>Cycle action is performed according to deviation.</p>		
Direct current output (OUT2)	<p>Changes continuously according to deviation.</p>		
Indicator (OUT)	<p>Lit Unlit</p>		
Indicator (EV2)	<p>Unlit Lit</p>		



: Turns ON (lit) or OFF (unlit).

———— : Represents Heating control action.

----- : Represents Cooling control action.

10.7 OUT2 (Heating/Cooling control) Action (When Setting Overlap band)

Control action			
Relay contact output (OUT1)	<p>Cycle action is performed according to deviation.</p>		
Non-contact voltage output (OUT1)	<p>Cycle action is performed according to deviation.</p>		
Direct current output (OUT1)	<p>Changes continuously according to deviation.</p>		
Relay contact output (OUT2)	<p>Cycle action is performed according to deviation.</p>		
Non-contact voltage output (OUT2)	<p>Cycle action is performed according to deviation.</p>		
Direct current output (OUT2)	<p>Changes continuously according to deviation.</p>		
Indicator (OUT)	<p>Lit Unlit</p>		
Indicator (EV2)	<p>Unlit Lit</p>		

- : Turns ON (lit) or OFF (unlit).
- : Represents Heating control action.
- : Represents Cooling control action.

11. Specifications

11.1 Standard Specifications

Rating

Rated scale	Input	Scale Range		Resolution
K		-200 to 1370 °C	-328 to 2498 °F	1 °C(°F)
		-200.0 to 400.0 °C	-328.0 to 752.0 °F	0.1 °C(°F)
J		-200 to 1000 °C	-328 to 1832 °F	1 °C(°F)
R		0 to 1760 °C	32 to 3200 °F	1 °C(°F)
S		0 to 1760 °C	32 to 3200 °F	1 °C(°F)
B		0 to 1820 °C	32 to 3308 °F	1 °C(°F)
E		-200 to 800 °C	-328 to 1472 °F	1 °C(°F)
T		-200.0 to 400.0 °C	-328.0 to 752.0 °F	0.1 °C(°F)
N		-200 to 1300 °C	-328 to 2372 °F	1 °C(°F)
PL-II		0 to 1390 °C	32 to 2534 °F	1 °C(°F)
C(W/Re5-26)		0 to 2315 °C	32 to 4199 °F	1 °C(°F)
Pt100		-200.0 to 850.0 °C	-328.0 to 1562.0 °F	0.1 °C(°F)
		-200 to 850 °C	-328 to 1562 °F	1 °C(°F)
JPt100		-200.0 to 500.0 °C	-328.0 to 932.0 °F	0.1 °C(°F)
		-200 to 500 °C	-328 to 932 °F	1 °C(°F)
4 – 20 mA		-2000 to 10000 (*)		1
0 – 20 mA		-2000 to 10000 (*)		1
0 – 1 V		-2000 to 10000 (*)		1
0 – 5 V		-2000 to 10000 (*)		1
1 – 5 V		-2000 to 10000 (*)		1
0 – 10 V		-2000 to 10000 (*)		1
(*) Scaling and decimal point place selection are possible.				

Input

Input	Thermocouple	K, J, R, S, B, E, T, N, PL-II, C(W/Re5-26) External resistance: 100 Ω max. However, for B input, External resistance: 40 Ω max.
	RTD	Pt100, JPt100 3-wire type Allowable input lead wire resistance: 10 Ω max. per wire
	Direct current	0 to 20 mA DC, 4 to 20 mA DC Input impedance: 50 Ω Allowable input current: 50 mA DC max.
	DC voltage	0 – 1 V DC Input impedance: 1 MΩ min. Allowable input voltage: 5 V DC max. Allowable signal source resistance: 2 kΩ max. 0 – 5 V DC, 1 – 5 V DC, 0 – 10 V DC Input impedance: 100 kΩ min. Allowable input voltage: 15 V DC max. Allowable signal source resistance: 100 Ω max.
Event input (C5W, EIW, EIT, C5, EI options)		
	Input point	2 points
	Circuit current when closed	Approx. 16 mA
	Action	Edge action When the power is turned ON, level action is engaged.

Output

Control output OUT1	Relay contact 1a	Control capacity: 3 A 250 V AC (resistive load) 1 A 250 V AC (inductive load $\cos \phi = 0.4$) Electrical life: 100,000 cycles Minimum applicable load: 10 mA 5 V DC
	Non-contact voltage (for SSR drive)	12 V DC $\pm 15\%$ Max. 40 mA (short circuit protected)
	Direct current	4 - 20 mA DC (Resolution: 12000) Load resistance: Max. 550 Ω
Event output EV1		
	Relay contact 1a	Control capacity: 3 A 250 V AC (resistive load) 1 A 250 V AC (inductive load $\cos \phi = 0.4$) Electrical life: 100,000 cycles Minimum applicable load: 10 mA 5 V DC
Event output EV2 [EV2, EV3(DR) options]		
	Relay contact 1a	Control capacity: 3 A 250 V AC (resistive load) 1 A 250 V AC (inductive load $\cos \phi = 0.4$) Electrical life: 100,000 cycles Minimum applicable load: 10 mA 5 V DC
Event output EV3 (EV3D□, EI options)		
	Relay contact 1a	Control capacity: 3 A 250 V AC (resistive load) 1 A 250 V AC (inductive load $\cos \phi = 0.4$) Electrical life: 100,000 cycles Minimum applicable load: 10 mA 5 V DC
Control output OUT2 (EV2, EV3D□ options)		
	Relay contact 1a [EV2, EV3(DR) options]	Control capacity: 3 A 250 V AC (resistive load) 1 A 250 V AC (inductive load $\cos \phi = 0.4$) Electrical life: 100,000 cycles Minimum applicable load: 10 mA 5 V DC
	Non-contact voltage (for SSR drive) (DS, EV3DS options)	12 V DC $\pm 15\%$ Max. 40 mA (short circuit protected)
	Direct current (DA, EV3DA options)	4 - 20 mA DC (Resolution: 12000) Load resistance: Max. 550 Ω
Transmission output (EIT option)		
	Resolution	12000
	Output	4 - 20 mA DC (Load resistance: Max. 550 Ω)
	Output accuracy	Within $\pm 0.3\%$ of Transmission output span
	Response time	400 ms + Input sampling period (0% \rightarrow 90%)
Insulated power output (P24 option)		
	Output voltage	24 \pm 3 V DC (when load current is 30 mA DC)
	Ripple voltage	Within 200 mV DC (when load current is 30 mA DC)
	Max. load current	30 mA DC

Power

Power supply	Model	PCB1□00-□□	PCB1□10-□□
	Power supply	100 – 240 V AC, 50/60 Hz	24 V AC/DC, 50/60 Hz
	Allowable fluctuation range	85 – 264 V AC	20 – 28 V AC/DC
Power consumption	Power supply	Power consumption	
	100 – 240 V AC	Approx. 8 VA max. (When the maximum number of options are ordered: Approx. 11 VA max.)	
	24 V AC	Approx. 5 VA max. (When the maximum number of options are ordered: Approx. 8 VA max.)	
	24 V DC	Approx. 5 W max. (When the maximum number of options are ordered: Approx. 8 W max.)	
Inrush current	Power supply	Inrush current	
	100 – 240 V AC	Max. 14 to 34 A	
	24 V AC	Max. 34 A	
	24 V DC	Max. 34 A	

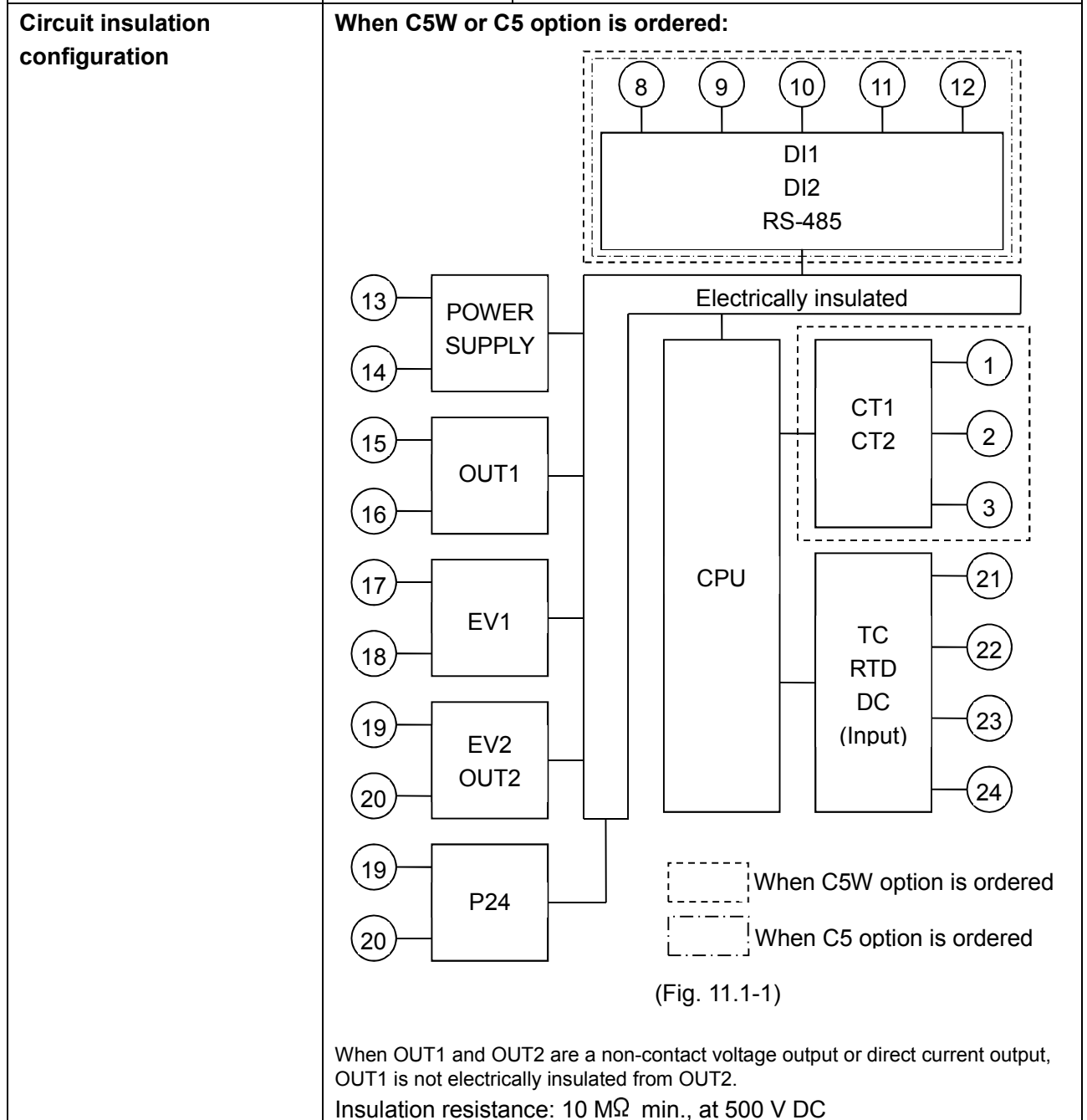

When EIW or W option is ordered:

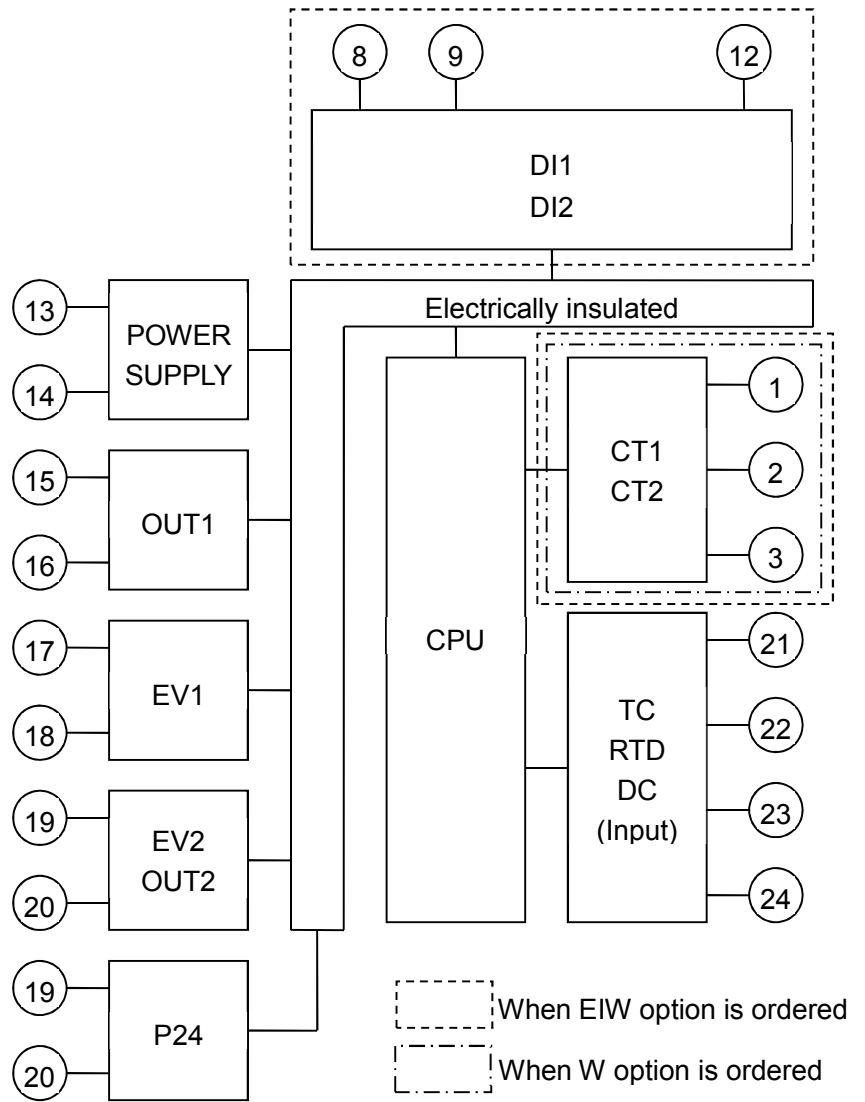

(Fig. 11.1-2)

When OUT1 and OUT2 are a non-contact voltage output or direct current output, OUT1 is not electrically insulated from OUT2.

Insulation resistance: 10 MΩ min., at 500 V DC

When EIT or EI option is ordered:

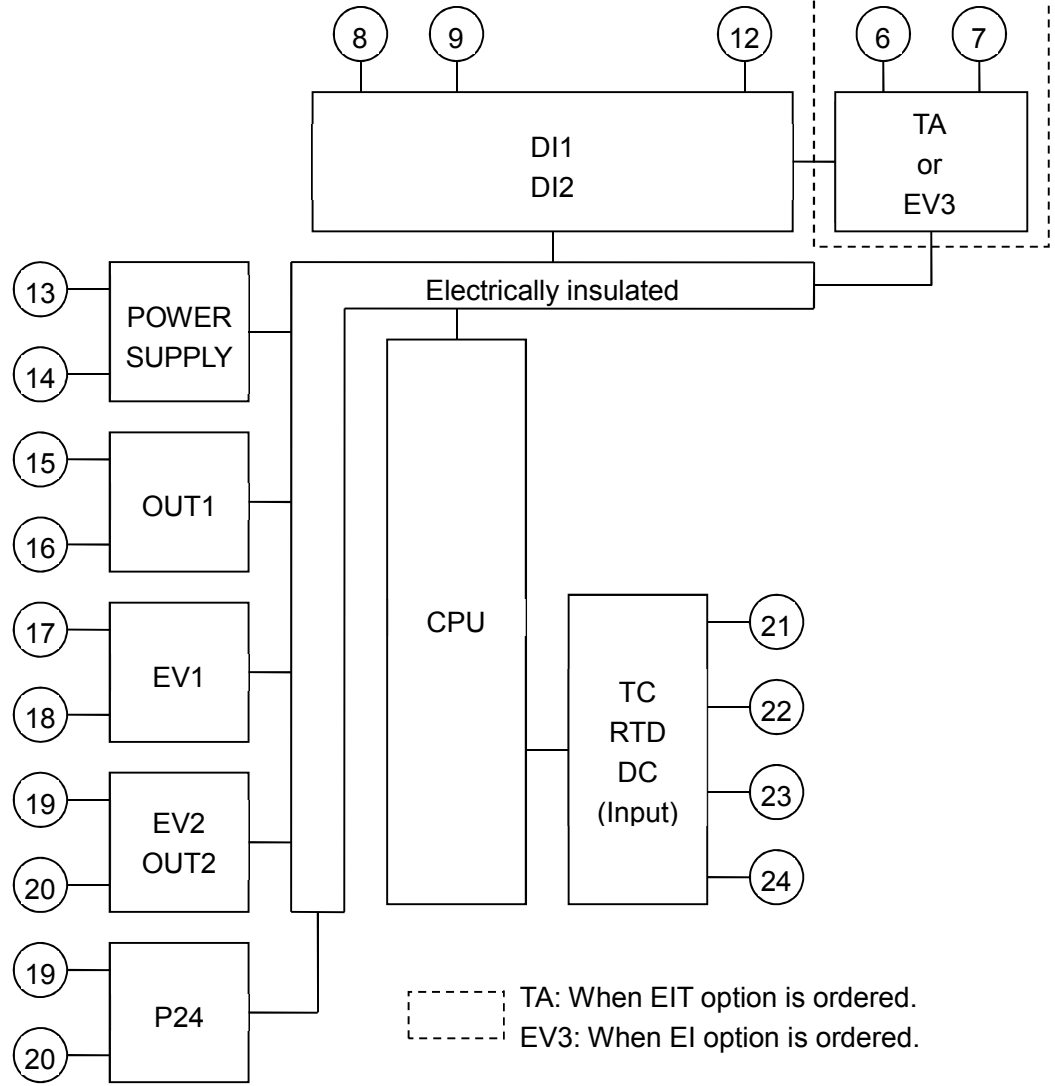

(Fig. 11.1-3)

When OUT1 and OUT2 are a non-contact voltage output or direct current output, OUT1 is not electrically insulated from OUT2.

Insulation resistance: 10 MΩ min., at 500 V DC

Dielectric strength

Between input terminal and power terminal: 1.5 kV AC for 1 minute
 Between output terminal and power terminal: 1.5 kV AC for 1 minute
 Between output terminal (P24) and power terminal: 500 V AC for 1 minute

Recommended Environment

Ambient temperature	-10 to 55°C (However, non-condensing or no icing)
Ambient humidity	35 to 85 %RH (However, non-condensing)
Environmental specification	RoHS directive compliant

Performance









Base accuracy		At ambient temperature 23°C (for a single unit mounting)
	Thermocouple	Within $\pm 0.2\%$ of each input span ± 1 digit However, R, S input, 0 to 200°C (32 to 392°F): Within $\pm 6^\circ\text{C}$ (12°F) B input, 0 to 300°C (32 to 572°F): Accuracy is not guaranteed. K, J, E, T, N input, Less than 0°C (32°F): Within $\pm 0.4\%$ of input span ± 1 digit
	RTD	Within $\pm 0.1\%$ of each input span ± 1 digit
	Direct current, DC voltage	Within $\pm 0.2\%$ of each input span ± 1 digit
Effect of ambient temperature		Within 50 ppm/°C of each input span
Input sampling period		125 ms
Time indication accuracy		Within $\pm 0.5\%$ of setting time
Setting resolution	Temperature	Thermocouple, RTD input without decimal point: 1°C (°F) Thermocouple, RTD input with decimal point: 0.1°C (°F) DC voltage, current input: 1
	Time	1 minute or 1 second

General Structure

Weight		Approx. 220 g
External dimensions		96 x 96 x 68 (W x H x D) (Depth of control panel interior: 60 mm)
Mounting		Flush (Applicable panel thickness: 1 to 7 mm)
Case		Flame-resistant resin, Color: Black
Front panel		Membrane sheet
Drip-proof/Dust-proof		IP66 for front panel only
Display	PV Display	In RUN mode, indicates process variable (PV). In setting mode, indicates setting characters. Flashes during Wait action or program control HOLD in program control. 7-segments Red LED display 4.5 digits Character size: 24.0 x 11.0 mm (H x W)
	SV Display	In RUN mode, indicates desired value (SV), Output manipulated variable (MV), or Remaining time (TIME). Retains display indication at power OFF. In setting mode, indicates the set values. 7-segments Green LED display 4.5 digits Character size: 14.0 x 7.0 mm (H x W)

	PTN/STEP Display	<p>Indicates the pattern number or step number.</p> <p>Each time the DISP key is pressed, the PTN/STEP Display and the PTN/STEP indicator alternately indicate the pattern number and step number.</p> <p>Flashes during Wait action, or when the step number is indicated.</p> <p>If 'SV digital reception' is selected in [Communication protocol], r is indicated.</p> <p>7-segments Orange LED display 1.5-digits Character size:14.0 x 7.0 mm (H x W)</p>
Indicator	PTN indicator	<p>Lights up when the pattern number is indicated on the PTN/STEP Display.</p> <p>Orange LED</p>
	STEP indicator	<p>Lights up when the step number is indicated on the PTN/STEP Display.</p> <p>Orange LED</p>
	PTN/STEP indicator	<p>LED for the pattern number or step number lights up.</p> <p>Each time the DISP key is pressed, the PTN/STEP indicator and the PTN/STEP Display alternately indicate the pattern number and step number.</p> <p>Green LED 12 pieces (PTN, STEP, 1 to 10)</p>
Action indicator	OUT (Green)	<p>Lights up when control output OUT1 is ON.</p> <p>Lights up when Heating output [DS, DA, EV2 (if 020 is selected in Event output EV2 allocation), EV3D□ options] is ON.</p> <p>For direct current output type, flashes corresponding to the MV in 125 ms cycles.</p>
	RUN (Orange)	<p>Lights up during program control RUN.</p> <p>Flashes during program control HOLD or Fixed value control.</p>
	EV1 (Red)	Lights up when Event output EV1 is ON.
	EV2 (Red)	<p>Lights up when Event output EV2 [(EV2, EV3(DR) options] is ON.</p> <p>Lights up when control output OUT2 [Cooling output: DS, DA, EV2 (if 020 is selected in Event output EV2 allocation), EV3D□ options] is ON.</p> <p>For direct current output type (DA, EV3DA options), flashes corresponding to the MV in 125 ms cycles.</p>
	EV3 (Red)	Lights up when Event output EV3 (EV3D□, EI options) is ON.
	AT (Orange)	Flashes while AT is performing.
	T/R (Orange)	<p>Lights up during serial communication (C5W, C5 options)</p> <p>TX (transmitting) output.</p>

Setting Structure

Function key		UP key	In setting mode, increases the numerical value. By pressing for approx. 1 sec during program control RUN, time progress pauses, and program control HOLD function initiates.
		DOWN key	In setting mode, decreases the numerical value.
		FAST key	In setting mode, makes the numeric value change faster. During program control RUN, makes step time progress 60 times faster.
		RESET key	In setting mode, registers the setting data, and moves to RUN mode.
		MODE key	In setting mode, registers the setting data, and moves to the next setting item.
		PATTERN key	During program control STOP (in Standby), selects a program pattern number to perform or to set. By pressing this key during program control RUN, the unit moves to Monitor mode. In Monitor mode, switches the indication item.
		Display key	During RUN mode, the PTN/STEP Display and PTN/STEP indicator alternately indicates the pattern number and step number. In setting mode, registers the setting data, and moves back to the previous mode.
		RUN key	Performs program control, or cancels program control HOLD function while program control is held. By pressing for approx. 1 second during program control RUN, stops performing step, and proceeds to the next step (Advance function initiates.).
		STOP key	Stops program control by pressing for approx. 1 second during program control RUN, or cancels pattern end output.

Program Performance

Number of patterns	10 patterns (Linkable)
Number of steps	100 (10 steps/pattern)
Number of repetitions	0 to 10000 times (Repetitions disabled when set to 0)
Program time range	0 to 99 hours 59 minutes/step, or 0 to 99 minutes 59 seconds/step (When - - - - is set: Fixed value control is performed using step SV.)
Wait value	Thermocouple, RTD inputs: 0 to 20% of input span DC voltage, current input: 0 to 20% of scaling span (The placement of the decimal point follows the selection.) (The Wait function is disabled when set to 0 or 0.0.)

Control Performance

Control action	<ul style="list-style-type: none"> • PID control action (with AT function) • PI control action (When derivative time is set to 0.) • PD control action (When integral time is set to 0.) • P control action (When integral and derivative time are set to 0.) • ON/OFF control action (When proportional band is set to 0 or 0.0.)
OUT1 proportional band (P)	Thermocouple, RTD input without decimal point: 0 to Input span°C (°F) Thermocouple, RTD input with decimal point: 0.0 to Input span°C (°F) DC voltage, current inputs: 0.0 to 1000.0% (ON/OFF control action when set to 0 or 0.0.)
Integral time (I)	0 to 3600 sec (Setting the value to 0 disables the function.)
Derivative time (D)	0 to 1800 sec (Setting the value to 0 disables the function.)
OUT1 proportional cycle	0.5, 1 to 120 sec
ARW	0 to 100%
OUT1 ON/OFF hysteresis	0.1 to 1000.0°C (°F) DC voltage, current inputs: 1 to 10000 (The placement of the decimal point follows the selection.)
OUT1 high limit, OUT1 low limit	0 to 100% (Direct current output: -5 to 105%)

Standard Function

Wait function	During program control, the program does not proceed to the next step until the deviation between PV and SV enters $SV \pm \text{Wait}$ value at the end of step. The PV Display and PTN/STEP Display flash while the Wait function is working.
Program control HOLD function	During program control RUN, progress of current step can be suspended. During program control RUN, if the  key is pressed for approx. 1 second, the program control HOLD function is enabled. While the program control HOLD function is working, the PV Display and RUN indicator flash. Pressing the RUN key cancels suspension, and program control resumes.
Advance function	Interrupts current step during program control RUN, and proceeds to the beginning of the next step. During program control RUN, if the RUN key is pressed for approx. 1 second, the Advance function is enabled.
Pattern link and repetitions function	Patterns 1 to 10 can be linked to the next pattern (of each pattern). For Pattern 10, Pattern 1 can be linked. Number of repetitions for Patterns 1 to 10: 0 to 10000 times. For repetitions of linked patterns, the whole linked pattern will be repeated as many times as set for the former pattern.
Step SV when program control starts	Program control starts from the step SV set in [Step SV when program control starts].

Program control start type	<p>Selects program control start type.</p> <p>PV start: Only when program control starts, the step SV is advanced to the PV, then program control starts.</p> <p>PVR start: When program control starts and in pattern repeating, the step SV is advanced to the PV, then program control starts.</p> <p>SV start: Program control starts from the step SV which has been set in [Step SV when program control starts].</p>
Power restore action	<p>If power fails during program control RUN, the controller can be operated depending on the selection in [Power restore action].</p> <p>Stops after power is restored: Stops current program control, and returns to program control STOP (in Standby).</p> <p>Continues after power is restored: Continues (Resumes) previous program control after power is restored.</p> <p>Suspends after power is restored: Suspends (on hold) current program control, and performs Fixed value control using the step SV at the time of suspension. Pressing the RUN key cancels suspension, and program control resumes.</p> <p>Progressing time error when power is restored: 1 minute or 1 second</p>
Step time speed-up function	<p>During program control RUN, makes step time progress 60 times faster while the FAST key is pressed.</p> <p>If the Wait function is set, the Wait function has priority.</p>
Event output EV1	<p>Output turns ON or OFF, depending on Event condition selected in [Event output EV1 allocation]:</p> <p>Alarm output, Heater burnout alarm output, Loop break alarm output, Time signal output, Output during AT, Pattern end output, Output by communication command, RUN output</p>
Alarm action	<p>Selects any alarm action in [Event output EV□ allocation] from the following:</p> <p>High limit alarm, Low limit alarm, High/Low limits alarm, High/Low limits independent alarm, High/Low limit range alarm, High/Low limit range independent alarm, Process high alarm, Process low alarm, High limit with standby alarm, Low limit with standby alarm, High/Low limits with standby alarm, High/Low limits with standby independent alarm</p> <p>Alarm Energized/De-energized action are applied to the above alarms, totaling 24 alarm types. No alarm action can also be selected.</p>
Set value	Factory default value: 0
Action	ON/OFF action
Alarm hysteresis	0.1 to 1000.0°C (°F) DC voltage, current input: 1 to 10000 (The placement of the decimal point follows the selection.)
Output	EV□ output for which Alarm output (001 to 012) is selected in [Event output EV□ allocation].

Loop break alarm	When Loop break alarm is selected in [Event output EV□ allocation], detects actuator trouble (heater burnout, heater adhesion) or sensor burnout.
Loop break alarm time	0 to 200 minutes
Loop break alarm span	Thermocouple, RTD input without decimal point: 0 to 150°C (°F) Thermocouple, RTD input with decimal point: 0.0 to 150.0°C (°F) DC voltage, current input: 0 to 1500 (The placement of the decimal point follows the selection.)
Output	EV□ output for which Loop break alarm output is selected in [Event output EV□ allocation].
Time signal output	When Time signal output is selected in [Event output EV□ allocation], Time signal output activates during Time signal output ON time within one pattern total time. Time signal output ON time follows Time signal output OFF time after the program control starts. During Wait action or program control HOLD, progress time of Time signal output stops. When step time is changed during program control RUN, Time signal output timing is re-calculated using the pattern time after change.
Output during AT	When 'Output during AT' is selected in [Event output EV□ allocation], turns ON during AT.
Pattern end output	When Pattern end output is selected in [Event output EV□ allocation], Pattern end output is turned ON during Pattern end output time after program control is finished, and the SV Display flashes P E n d . By pressing the STOP key for approximately 1 second, Pattern end output is turned OFF, and the unit returns to program control STOP (in Standby). If Pattern end output time is set, Pattern end output is automatically turned OFF after Pattern end output time has expired. The unit returns to program control STOP (in Standby).
RUN output	When 'RUN output' is selected in [Event output EV□ allocation], turns ON during program control RUN.
Data clear function	During program control STOP (in Standby), if the ▲ , ▼ and STOP keys (in that order) are pressed together for approx. 3 seconds, the PV Display indicates CL R , and the unit enters [Data clear Yes/No]. Select YES (Data clear Yes), and press the MODE key. The PV Display indicates ! 0 ! for approx. 3 seconds, and all data will return to factory default values.

Attached Functions

Sensor correction coefficient	Sets slope of input value from a sensor.
Sensor correction	Corrects the input value from a sensor.
Set value lock	Locks the set values to prevent setting errors.
Power failure countermeasure	The setting data is backed up in the non-volatile IC memory.
Self-diagnosis	The CPU is monitored by a watchdog timer, and if an abnormal status occurs, the controller is switched to warm-up status, turning all outputs OFF.
Automatic cold junction temperature compensation	Detects the temperature at the connection terminal between the thermocouple and the instrument, and maintains it at the same status as if the reference junction location temperature were at 0°C (32°F).
Indication range, Control range	<p>Thermocouple input: [Input range low limit value – 50°C (100°F)] to [Input range high limit value + 50°C (100°F)]</p> <p>RTD input: [Input range low limit value – (Input span x 1%)] to [Input range high limit value + 50°C (100°F)]</p> <p>DC voltage, current inputs: [Scaling low limit value – (Scaling span x 1%)] to [Scaling high limit value + (Scaling span x 10%)]</p>
Input error (Overscale, Underscale)	<p>If input errors (overscale, underscale) occur, the following will be performed depending on the selection in [Error indication].</p> <p>If 'Disabled' is selected in [Error indication]:</p> <p>Overscale occurs if PV has exceeded Input range high limit value (Scaling high limit value for DC voltage, current inputs). The PV Display indicates PV.</p> <p>Underscale occurs if PV has dropped below Input range low limit value (Scaling low limit value for DC voltage, current inputs). The PV Display indicates PV.</p> <p>If 'Enabled' is selected in [Error indication]:</p> <p>Overscale occurs if PV has exceeded Input range high limit value (Scaling high limit value for DC voltage, current inputs). The PV Display indicates the PV and error code $E\text{-}OS$ alternately.</p> <p>Underscale occurs if PV has dropped below Input range low limit value (Scaling low limit value for DC voltage, current inputs). The PV Display indicates the PV and error code $E\text{-}OE$ alternately.</p>

Burnout

If burnout occurs, the following will be performed depending on the selection in [Error indication].

If 'Disabled' is selected in [Error indication]:

If PV has exceeded Indication range and Control range, the PV Display flashes $\overline{\text{---}}$. OUT1 and OUT2 are turned OFF (OUT1 low limit value for direct current output, OUT2 low limit value for DA, EV3DA).

If PV has dropped below Indication range and Control range, the PV Display flashes $\underline{\text{---}}$. OUT1 and OUT2 are turned OFF (OUT1 low limit value for direct current output, OUT2 low limit value for DA, EV3DA).

If thermocouple or RTD input is burnt out, or if DC voltage (0 – 1 V DC) input is disconnected, the PV Display flashes --- .

If the following DC voltage or current input is disconnected:

4 – 20 mA DC, 1 – 5 V DC inputs: The PV Display flashes --- .

0 – 20 mA DC, 0 – 5 V DC, 0 – 10 V DC inputs: The PV Display indicates the value corresponding with 0 mA DC or 0 V DC input.

If Alarm output, Heater burnout alarm output or Loop break alarm output is selected in [Event output EV□ allocation], Event output will be turned ON under the alarm active conditions.

Burnout is enabled even in program control STOP (in Standby) status. However, Event output is not turned ON.

[Output status when input errors occur] can be used only for controllers using direct current and voltage inputs, and direct current output.

Output status differs depending on selection in [Output status when input errors occur].

Output status when input errors occur	Contents, Indication	Output Status			
		OUT1		OUT2	
		Direct (Cooling) action	Reverse (Heating) action	Direct (Cooling) action	Reverse (Heating) action
$\overline{\text{on}}$	[$\overline{\text{---}}$] flashes.	ON (20mA) or OUT1 high limit value (*)	OFF (4mA) or OUT1 low limit value	OFF or OUT2 low limit value	ON or OUT2 high limit value (*)
$\overline{\text{off}}$		OFF (4mA) or OUT1 low limit value			OFF or OUT2 low limit value
$\underline{\text{on}}$	[$\underline{\text{---}}$] flashes.	OFF (4mA) or OUT1 low limit value	ON (20mA) or OUT1 high limit value (*)	ON or OUT2 high limit value (*)	OFF or OUT2 low limit value
$\underline{\text{off}}$			OFF (4mA) or OUT1 low limit value	OFF or OUT2 low limit value	

(*) Outputs a value between OFF (4mA) and ON (20mA) or between OUT1 (or OUT2) low limit value and OUT1 (or OUT2) high limit value, depending on deviation.

If 'Enabled' is selected in [Error indication]:

If PV has exceeded Indication range and Control range, the PV Display indicates $\overline{\text{---}}$ and $\overline{\text{Er-07}}$ alternately. OUT1 and OUT2 are turned OFF (OUT1 low limit value for direct current output, OUT2 low limit value for DA, EV3DA).

If PV has dropped below Indication range and Control range, the PV Display indicates $\underline{\text{---}}$ and $\underline{\text{Er-07}}$ alternately. OUT1 and OUT2 are turned OFF (OUT1 low limit value for direct current output, OUT2 low limit value for DA, EV3DA).

If thermocouple, RTD or DC voltage (0 to 1 V DC) input is burnt out or disconnected, the PV Display indicates --- and Er-07 alternately.

If the following DC voltage or current input is disconnected:

4 – 20 mA DC, 1 – 5 V DC inputs: The PV Display indicates --- and Er-07 alternately.

0 – 20 mA DC, 0 – 5 V DC, 0 – 10 V DC inputs: The PV Display indicates the value corresponding with 0 mA DC or 0 V DC input.

If Alarm output, Heater burnout alarm output or Loop break alarm output is selected in [Event output EV□ allocation], Event output will be turned ON under the alarm active conditions.

Burnout is enabled even in program control STOP (in Standby) status. However, Event output is not turned ON.

[Output status when input errors occur] can be used only for controllers using direct current and voltage inputs, and direct current output.

Output status differs depending on selection in [Output status when input errors occur].

Output status when input errors occur	Contents, Indication	Output Status			
		OUT1		OUT2	
		Direct (Cooling) action	Reverse (Heating) action	Direct (Cooling) action	Reverse (Heating) action
ON□□	Indicates [- - - -] and [Err□□] alternately.	ON (20mA) or OUT1 high limit value (*)	OFF (4mA) or OUT1 low limit value	OFF or OUT2 low limit value	ON or OUT2 high limit value (*)
OFF□□		OFF (4mA) or OUT1 low limit value			OFF or OUT2 low limit value
ON□□	Indicates [- - - -] and [Err□□] alternately.	OFF (4mA) or OUT1 low limit value	ON (20mA) or OUT1 high limit value (*)	ON or OUT2 high limit value (*)	OFF or OUT2 low limit value
OFF□□			OFF (4mA) or OUT1 low limit value	OFF or OUT2 low limit value	

(*) Outputs a value between OFF (4mA) and ON (20mA) or between OUT1 (or OUT2) low limit value and OUT1 (or OUT2) high limit value, depending on deviation.

Warm-up indication	After the power supply to the instrument is turned on, the PV Display indicates the input type, and SV Display indicates input range high limit value (for thermocouple, RTD inputs) or scaling high limit value (for direct current and voltage inputs) for approximately 3 seconds. Control output is OFF (0 mA for direct current output), and Transmission output is 0 mA.
Console communication	By connecting to the tool cable (CMD-001, sold separately) to the tool cable connector, the following operations can be conducted from an external computer, using the Console software SWC-PCB101M. Console communication and Serial communication (C5W, C5 options) cannot be used together. (1) Reading and writing of step SV, step time, PID and various set values (2) Reading of PV and action status (3) Function change Communication line: TTL level

Other

Accessories included	Mounting bracket: 1 set Instruction manual (excerpt): 1 copy
Accessories sold separately	Terminal cover CT (Current transformer): CTL-6-S-H (For Heater burnout alarm output 20 A) CTL-12-S36-10L1U (For Heater burnout alarm output 100 A) Tool cable CMD-001

11.2 Optional Specifications

Event output EV2 [EV2, EV3(DR) options]	Output will be turned ON or OFF depending on the Event conditions selected in [Event output EV2 allocation]. One output can be selected from the following: Alarm output, Heater burnout alarm output, Loop break alarm output, Time signal output, Output during AT, Pattern end output, Output by communication command, RUN output, Heating/Cooling control Relay contact output
Heating/Cooling control output [EV2(DR), DS, DA, EV3D□ options]	Performs Heating/Cooling control.
OUT2 proportional band	Thermocouple, RTD inputs without decimal point: 0 to Input span°C (°F) Thermocouple, RTD inputs with decimal point: 0.0 to Input span°C (°F) DC voltage, current inputs: 0.0 to 1000.0% (ON/OFF control when set to 0.0)
Integral time (I)	0 to 3600 seconds (Setting to 0 disables the function.) (Same as OUT1 integral time)
Derivative time (D)	0 to 1800 seconds (Setting to 0 disables the function.) (Same as OUT1 derivative time)
OUT2 proportional cycle	0.5, 1 to 120 seconds
Overlap/Dead band	Thermocouple, RTD inputs: -200.0 to 200.0°C (°F) DC voltage, current inputs: -2000 to 2000 (The placement of the decimal point follows the selection.)
OUT2 ON/OFF hysteresis	Thermocouple, RTD inputs: 0.1 to 1000.0°C (°F) DC voltage, current inputs 1 to 10000 (The placement of the decimal point follows the selection.)
OUT2 high limit, OUT2 low limit	0 to 100% (DA, EV3DA: -5 to 105%)
OUT2 cooling method	(1) Air cooling (linear characteristics), (2) Oil cooling (1.5th power of the linear characteristics) (3) Water cooling (2nd power of the linear characteristics)
Insulated power output (P24 option)	
Output voltage	24 ± 3 V DC (when load current is 30 mA DC)
Ripple voltage	Within 200 mV DC (when load current is 30 mA DC)
Max. load current:	30 mA DC
Event output EV3 (EV3D□, EI options)	Output will be turned ON or OFF depending on the Event conditions selected in [Event output EV3 allocation]. One output can be selected from the following: Alarm output, Heater burnout alarm output, Loop break alarm output, Time signal output, Output during AT, Pattern end output, Output by communication command, RUN output
Serial communication (C5W, C5 options)	The following operations can be carried out from an external computer. (1) Reading and writing of the step SV, step time, PID values and various set values (2) Reading of the PV and action status (3) Function change
Communication line	EIA RS-485
Communication method	Half-duplex communication
Communication speed	9600, 19200, 38400 bps (Selectable by keypad)
Synchronization method	Start-stop synchronization

Communication protocol		Shinko protocol, SV digital transmission, SV digital reception, Modbus ASCII mode, Modbus RTU mode (Selectable by keypad) Communication converter IF-400 is available for Shinko protocol and Modbus protocol.		
Data bit/Parity		Data bit: 7, 8 (Selectable by keypad) Parity: Even, Odd, No parity (Selectable by keypad)		
Stop bit:		1, 2 (Selectable by keypad)		
Data format	Communication Protocol	Shinko Protocol	Modbus ASCII	Modbus RTU
	Start bit	1	1	1
	Data bit	7 (8) Selectable	7 (8) Selectable	8
	Parity	Even (No parity, Odd) Selectable	Even (No parity, Odd) Selectable	No parity (Even, Odd) Selectable
Stop bit	1 (2) Selectable	1 (2) Selectable	1 (2) Selectable	1 (2) Selectable
Response delay time		Response from the controller can be delayed after receiving command from the host computer. If Response delay time is changed via software communication, the changed delay time will be reflected from that response data. • Setting range: 0 to 1000 ms		

SV digital transmission

When 'SV digital transmission (Shinko protocol)' is selected in [Communication protocol], step SV can be digitally transmitted to the connected Shinko digital indicating controllers with the C5 (Serial communication) option.

When 'SV digital reception (Shinko protocol)' is selected in [Communication protocol], step SV can be received via SVTC command from the connected Shinko programmable controllers.

Shinko programmable controllers:

- PC-900 with SVTC (SV digital transmission) option
- PCD-33A with SVTC (SV digital transmission) option
- PCA1 for which 'SV digital transmission' is selected in [Communication protocol]
- PCB1 for which 'SV digital transmission' is selected in [Communication protocol]

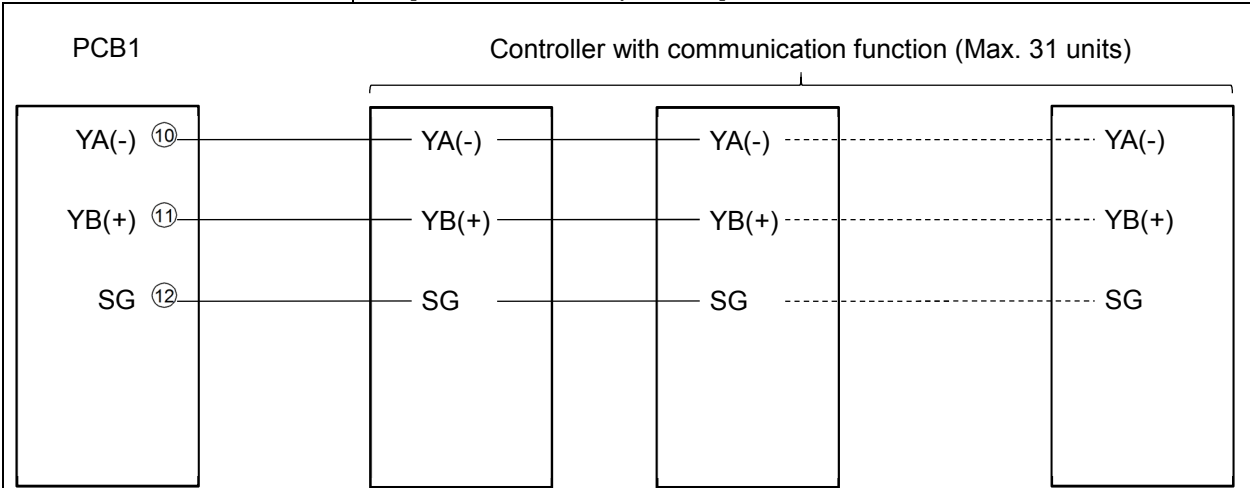

(Fig. 11.2-1)

Heater burnout alarm (C5W, EIW, W options)	Monitors heater current with CT (current transformer), and detects heater burnout. EV□ output, for which Heater burnout alarm is selected in [Event output EV□ allocation], will be turned ON or OFF. This alarm is also activated when the input is burnt out.
Rated current:	20 A, 100 A (Must be specified when ordering.) Single-phase: Detects burnout with CT1 input. 3-phase: Detects burnout with CT1 and CT2 inputs.
Setting accuracy	±5% of the rated value
Transmission output (EIT option)	Converting the value (PV, SV or MV transmission) to analog signal every 125 ms, outputs the value in current. Outputs Transmission output low limit value if Transmission output high limit and low limit value are the same. If SV or MV transmission is selected, 4 mA is output during program control STOP (in Standby).
Event input (C5W, EIW, EIT, C5, EI options)	Action can be switched by event conditions selected in [Event input DI□ allocation]. One function can be selected from the following: Pattern number selection, Direct/Reverse action, Program control RUN/STOP, Program control Holding/Not holding, Program control Advance function Signal edge action from OFF to ON / ON to OFF is engaged. However, when power is turned ON, level action is engaged except Program control Advance function.

12. Troubleshooting



Warning

Turn the power supply to the instrument off before wiring or checking. Working on or touching the terminal with the power switched on may result in severe injury or death due to electrical shock.

Moreover, the instrument must be grounded before the power supply to the instrument is turned on.

If any malfunctions occur, refer to the following items after checking that power is being supplied to the controller.

12.1 Indication

Problem	Possible Cause	Solution
The PV Display indicates $E-01$.	Internal non-volatile IC memory is defective.	Cancel the error code by pressing the MODE key, and perform data clearing.(p.90) If the problem is not still solved after power is turned ON again, contact our agency or us.
The PV Display indicates $E-02$.	Data writing (in non-volatile IC memory) error when power failure occurs.	Cancel the error code by pressing the MODE key, and execute data clearing. (P.90)
The PV Display indicates PV and $E-05$ (*) alternately.	Overscale. PV has exceeded Input range high limit value (scaling high limit value for DC voltage, current inputs).	Check the input signal source.
The PV Display indicates PV and $E-06$ (*) alternately.	Underscale. PV has dropped below Input range low limit value (scaling low limit value for DC voltage, current inputs).	Check the input signal source and wiring of input terminals.
The PV Display flashes $----$.	PV has exceeded the Indication range and Control range.	Check the input signal source.
The PV Display indicates $----$ and $E-07$ (*) alternately.	Burnout of thermocouple, RTD or disconnection of DC voltage (0 to 1 V DC)	Replace each sensor. How to check whether the sensor is burnt out: [Thermocouple] If the input terminals of the instrument are shorted, and if a value around room temperature is indicated, the instrument is likely to be operating normally, however, the sensor may be burnt out. [RTD] If approx. 100 Ω of resistance is connected to the input terminals between A-B of the instrument and between B-B is shorted, and if a value around 0°C (32°F) is indicated, the instrument is likely to be operating normally, however, the sensor may be burnt out. [DC voltage (0 to 1 V DC)] If the input terminals of the instrument are shorted, and if a scaling low limit value is indicated, the instrument is likely to be operating normally, however, the signal wire may be disconnected.

(*) Available when 'Enabled' is selected in [Error indication].

Problem	Possible Cause	Solution
	Check whether the input terminals of thermocouple, RTD or DC voltage (0 to 1 V DC) are securely mounted to the instrument input terminals.	Connect the sensor terminals to the instrument input terminals securely.
The PV Display flashes [_ _ _ _].	PV has dropped below the Indication range and Control range.	Check the input signal source and wiring of input terminals.
The PV Display indicates [_ _ _ _] and [Err 01] (*) alternately.	Check whether input signal wire for direct current (4 to 20 mA DC) or DC voltage (1 to 5 V DC) is disconnected.	How to check whether the input signal wire is disconnected: [Direct current (4 to 20 mA DC)] If the input to the input terminals of the instrument is 4 mA DC and if a scaling low limit value is indicated, the instrument is likely to be operating normally, however, the signal wire may be disconnected. [DC voltage (1 to 5 V DC)] If the input to the input terminals of the instrument is 1 V DC and if a scaling low limit value is indicated, the instrument is likely to be operating normally, however, the signal wire may be disconnected.
	Check whether input signal wire for direct current (4 to 20 mA DC) or DC voltage (1 to 5 V DC) is securely connected to the instrument input terminals.	Connect the input signal wire to the terminals of this instrument securely.
	Check if polarity of thermocouple or compensating lead wire is correct. Check whether codes (A, B, B) of RTD agree with the instrument terminals.	Wire them correctly.
The PV Display indicates [Err 10].	Hardware malfunction	Contact our agency or us.
The indication of PV Display is irregular or unstable.	Check whether sensor input or temperature unit (°C or °F) is correct.	Select the sensor input and temperature unit (°C or °F) correctly.
	Sensor correction coefficient or Sensor correction value is unsuitable.	Set them to suitable values.
	Check whether the sensor specification is correct.	Use a sensor with appropriate specifications.
	AC leaks into the sensor circuit.	Use an ungrounded type sensor.
	There may be equipment that interferes with or makes noise near the instrument.	Keep the instrument clear of any potentially disruptive equipment.

(*) Available when 'Enabled' is selected in [Error indication].

Problem	Possible Cause	Solution
The PV Display keeps indicating the value set in [Scaling low limit].	Check whether the input signal wire for direct current (0 to 20 mA DC) and DC voltage (0 to 5 V DC, 0 to 10 V DC) is disconnected.	Check the input signal wires of direct current (0 to 20 mA DC) and DC voltage (0 to 5 V DC, 0 to 10 V DC). How to check whether the input signal wire is disconnected: [Direct current (0 to 20 mA DC)] If the input to the input terminal of this controller is 4 mA DC, and if a value (converted value from scaling high, low limit setting) corresponding to 4 mA DC is indicated, the controller is likely to be operating normally, however, the input signal wire may be disconnected. [DC voltage (0 to 5 V DC, 0 to 10 V DC)] If the input to the input terminal of this controller is 1 V DC, and if a value (converted value from scaling high, low limit setting) corresponding to 1 V DC is indicated, the controller is likely to be operating normally, however, the input signal wire may be disconnected.
	Check whether the input terminals for direct current (0 to 20 mA DC) or DC voltage (0 to 5 V DC, 0 to 10 V DC) are securely connected to the instrument input terminals.	Connect the input terminals of direct current or DC voltage to the input terminals of this instrument securely.

12.2 Key Operation

Problem	Possible Cause	Solution
The following values cannot be set: Step SV, step time, OUT1 proportional band, EV□ alarm value, etc.	Set value lock (Lock 1 or Lock 4) is selected.	Release the lock in [Set value lock].
	AT is performing.	Cancel AT.
Only step SV, step time and EV □ Alarm value can be set. Other settings are not possible.	Set value lock (Lock 2 or Lock 5) is selected.	Release the lock in [Set value lock].
The setting indication does not change in the input range, and new values are unable to be set.	Scaling high or low limit value may be set at the point where the value does not change.	Set it to a suitable value.
A pattern number cannot be selected by the PTN key.	A pattern number might be selected by means of Event input. The pattern number selected via Event input has priority over a pattern number selected by the PTN key.	Open (OFF) the SG terminal and any one terminal of Event input (DI1, DI2).

12.3 Control

Problem	Possible Cause	Solution
Even though program control is executed, the control is advanced and the program is finished soon.	The step time of the performing pattern number is set to 00:00.	Set the step time to a suitable value.
Step does not progress.	Program control is suspended (program control HOLD function). While program control is suspended, the PV Display and RUN indicator flash.	Press the RUN key. Suspension of control will be cancelled, and program control will resume.
	The Wait function is working. If the Wait function works, the PV Display and PTN/STEP Display flash.	Press the RUN key for approx. 1 second to cancel the Wait function. The Wait function will be cancelled, and program control will resume.
PV does not rise or fall.	Sensor is out of order.	Replace the sensor.
	Check whether the sensor or control output terminals are securely mounted to the instrument input terminals.	Ensure that the sensor or control output terminals are mounted to the instrument input terminals securely.
	Check whether the wiring of sensor or control output terminals is correct.	Wire them correctly.
Control output OUT1 or OUT2 remains in an ON status.	OUT1 or OUT2 low limit value is set to 100% or higher.	Set it to a suitable value.
The control output OUT1 or OUT2 remains in an OFF status.	OUT1 or OUT2 high limit value is set to 0% or less.	Set it to a suitable value.
The PV Display indicates E-20	AT has not been completed even if approx. 4 hours have elapsed since AT started.	Manually set P, I, D and ARW values.

13. Character Table

• Explanation of Setting Item

(e.g.) Setting Step 1 SV

Upper left: PV Display

Indicates setting item characters.

Lower left: PTN/STEP Display, SV Display

The PTN/STEP Display indicates the selected pattern number, and indication is different depending on the setting item.

The SV Display indicates factory default.

Right side: Indicates the setting item, explanation of its function, and setting range.

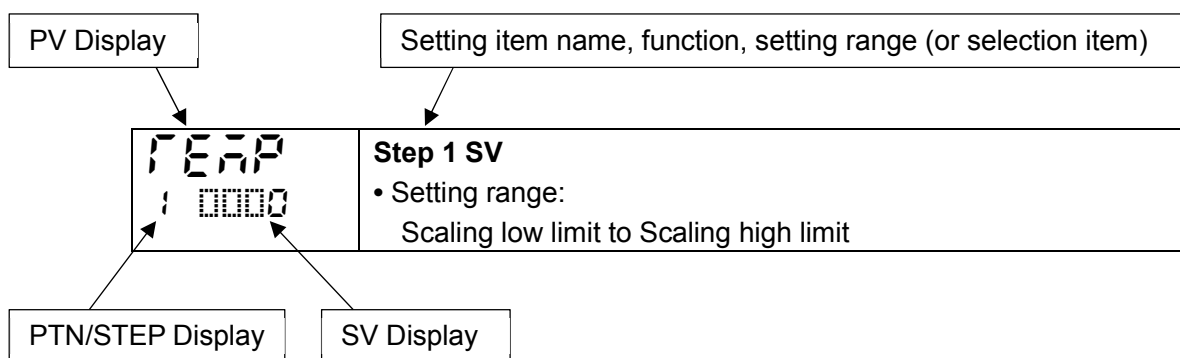

13.1 Error Code







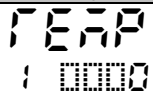

Error codes are indicated on the PV Display.

Error Code	Error Contents	Occurrence
E-01 : 0500(*1)	Internal non-volatile IC memory (EEPROM) is defective.	When power is turned ON
E-02 : 0500(*1)	Data writing error when power failure occurs.	When power is turned ON
E-05 : 0500(*2)	PV has exceeded Input range high limit value (Scaling high limit value for DC voltage, current inputs).	When operating
E-06 : 0500(*2)	PV has dropped below Input range low limit value (Scaling low limit value for DC voltage, current inputs).	When operating
E-07 : 0500(*2)	Input burnout or disconnection. Input value is outside of the Indication range and Control range.	When operating
E-10 : 0500	Hardware malfunction or errors (This error cannot be cancelled.)	When operating
E-20 : 0500(*1)	AT has not been completed even if approx. 4 hours have elapsed since AT started. When input errors have occurred.	After AT starts

(*1) Can be cancelled by the **MODE** key.

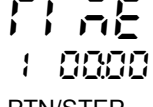
(*2) An error code is indicated when Enabled is selected in [Error indication].

13.2 Pattern Setting Mode

Characters, Factory Default	Setting Item, Setting Range	Data
 PTN/STEP indicator 1 lights.	Step 1 SV Scaling low limit to Scaling high limit	
 PTN/STEP indicator 1 lights.	Step 1 time - - - - , 00:00 to 99.59 (Time unit follows the selection in [Step time unit].) If the <input type="checkbox"/> key is pressed at 00:00, - - - - will be indicated. If - - - - is set, Fixed value control will be performed using Step 1 SV.	
 PTN/STEP indicator 1 lights.	Step 1 PID block number 1 to 10	
 PTN/STEP indicator 2 lights.	Step 2 SV Scaling low limit to Scaling high limit	
 PTN/STEP indicator 2 lights.	Step 2 time - - - - , 00:00 to 99.59 (Time unit follows the selection in [Step time unit].) If the <input type="checkbox"/> key is pressed at 00:00, - - - - will be indicated. If - - - - is set, Fixed value control will be performed using Step 2 SV.	
 PTN/STEP indicator 2 lights.	Step 2 PID block number 1 to 10	
 PTN/STEP indicator 3 lights.	Step 3 SV Scaling low limit to Scaling high limit	
 PTN/STEP indicator 3 lights.	Step 3 time - - - - , 00:00 to 99.59 (Time unit follows the selection in [Step time unit].) If the <input type="checkbox"/> key is pressed at 00:00, - - - - will be indicated. If - - - - is set, Fixed value control will be performed using Step 3 SV.	
 PTN/STEP indicator 3 lights.	Step 3 PID block number 1 to 10	















Characters, Factory Default	Setting Item, Setting Range	Data
 PTN/STEP indicator 4 lights.	Step 4 SV Scaling low limit to Scaling high limit	
 PTN/STEP indicator 4 lights.	Step 4 time ----, 00:00 to 99.59 (Time unit follows the selection in [Step time unit].) If the <input type="checkbox"/> key is pressed at 00:00, ---- will be indicated. If ---- is set, Fixed value control will be performed using Step 4 SV.	
 PTN/STEP indicator 4 lights.	Step 4 PID block number 1 to 10	
 PTN/STEP indicator 5 lights.	Step 5 SV Scaling low limit to Scaling high limit	
 PTN/STEP indicator 5 lights.	Step 5 time ----, 00:00 to 99.59 (Time unit follows the selection in [Step time unit].) If the <input type="checkbox"/> key is pressed at 00:00, ---- will be indicated. If ---- is set, Fixed value control will be performed using Step 5 SV.	
 PTN/STEP indicator 5 lights.	Step 5 PID block number 1 to 10	
 PTN/STEP indicator 6 lights.	Step 6 SV Scaling low limit to Scaling high limit	
 PTN/STEP indicator 6 lights.	Step 6 time ----, 00:00 to 99.59 (Time unit follows the selection in [Step time unit].) If the <input type="checkbox"/> key is pressed at 00:00, ---- will be indicated. If ---- is set, Fixed value control will be performed using Step 6 SV.	
 PTN/STEP indicator 6 lights.	Step 6 PID block number 1 to 10	

Characters, Factory Default	Setting Item, Setting Range	Data
 PTN/STEP indicator 7 lights.	Step 7 SV Scaling low limit to Scaling high limit	
 PTN/STEP indicator 7 lights.	Step 7 time ----, 00:00 to 99.59 (Time unit follows the selection in [Step time unit].) If the <input type="checkbox"/> key is pressed at 00:00, ---- will be indicated. If ---- is set, Fixed value control will be performed using Step 7 SV.	
 PTN/STEP indicator 7 lights.	Step 7 PID block number 1 to 10	
 PTN/STEP indicator 8 lights.	Step 8 SV Scaling low limit to Scaling high limit	
 PTN/STEP indicator 8 lights.	Step 8 time ----, 00:00 to 99.59 (Time unit follows the selection in [Step time unit].) If the <input type="checkbox"/> key is pressed at 00:00, ---- will be indicated. If ---- is set, Fixed value control will be performed using Step 8 SV.	
 PTN/STEP indicator 8 lights.	Step 8 PID block number 1 to 10	
 PTN/STEP indicator 9 lights.	Step 9 SV Scaling low limit to Scaling high limit	
 PTN/STEP indicator 9 lights.	Step 9 time ----, 00:00 to 99.59 (Time unit follows the selection in [Step time unit].) If the <input type="checkbox"/> key is pressed at 00:00, ---- will be indicated. If ---- is set, Fixed value control will be performed using Step 9 SV.	
 PTN/STEP indicator 9 lights.	Step 9 PID block number 1 to 10	

Characters, Factory Default	Setting Item, Setting Range	Data
FEAP 1 0000 PTN/STEP indicator 10 lights.	Step 10 SV Scaling low limit to Scaling high limit	
TIME 1 0000 PTN/STEP indicator 10 lights.	Step 10 time - - - - , 00:00 to 99.59 (Time unit follows the selection in [Step time unit].) If the <input type="checkbox"/> key is pressed at 00:00, - - - - will be indicated. If - - - - is set, Fixed value control will be performed using Step 10 SV.	
PID 1 0001 PTN/STEP indicator 10 lights.	Step 10 PID block number 1 to 10	
REP 1 0000 PTN/STEP indicator turns off.	Number of repetitions 0 to 10000	
CH n 1 - - - - PTN/STEP indicator turns off.	Pattern link	
	- - - - Pattern link Disabled	
	CH n Pattern link Enabled	

13.3 Event Setting Mode

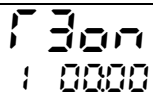
Characters, Factory Default	Setting Item, Setting Range	Data
<p>A 100 : 0000</p>	<p>EV1 alarm value</p> <p>High limit alarm -(Input span) to Input span (*1) Low limit alarm -(Input span) to Input span (*1) High/Low limits alarm 0 to Input span (*1) High/Low limits independent alarm 0 to Input span (*1) High/Low limit range alarm 0 to Input span (*1) High/Low limit range independent alarm 0 to Input span (*1) Process high alarm Input range low limit to Input range high limit (*2) Process low alarm Input range low limit to Input range high limit (*2) High limit with standby alarm -(Input span) to Input span (*1) Low limit with standby alarm -(Input span) to Input span (*1) High/Low limits with standby alarm 0 to Input span (*1) High/Low limits with standby independent alarm 0 to Input span (*1)</p> <p>(*1) For DC voltage, current inputs, the input span is the same as the scaling span. (The placement of the decimal point follows the selection.)</p> <p>(*2) For DC voltage, current inputs, input range low (or high) limit value is the same as scaling low (or high) limit value. (The placement of the decimal point follows the selection.)</p> <p>Available when 000 1 (High limit alarm) to 00 12 (High/Low limits with standby independent alarm) is selected in [Event output EV1 allocation].</p>	
<p>A 140 : 0000</p>	<p>EV1 high limit alarm value</p> <p>Setting range: Same as those of EV1 alarm value.</p> <p>Available when 0004 (High/Low limits independent alarm), 0005 (High/Low limit range independent alarm) or 00 12 (High/Low limits with standby independent alarm) is selected in [Event output EV1 allocation].</p>	
<p>F 10F : 0000</p>	<p>TS1 output OFF time</p> <p>Setting range: 00:00 to 99:59 (Time unit follows the selection in [Step time unit].)</p> <p>Available when 00 15 (Time signal output) is selected in [Event output EV1 allocation].</p>	
<p>F 10n : 0000</p>	<p>TS1 output ON time</p> <p>Setting range: 00:00 to 99:59 (Time unit follows the selection in [Step time unit].)</p> <p>Available when 00 15 (Time signal output) is selected in [Event output EV1 allocation].</p>	
<p>A200 : 0000</p>	<p>EV2 alarm value</p> <p>Setting range: Same as those of EV1 alarm value.</p> <p>Available when 000 1 (High limit alarm) to 00 12 (High/Low limits with standby independent alarm) is selected in [Event output EV2 allocation].</p>	
<p>A240 : 0000</p>	<p>EV2 high limit alarm value</p> <p>Setting range: Same as those of EV1 alarm value.</p> <p>Available when 0004 (High/Low limits independent alarm), 0005 (High/Low limit range independent alarm) or 00 12 (High/Low limits with standby independent alarm) is selected in [Event output EV2 allocation].</p>	

Characters, Factory Default	Setting Item, Setting Range	Data
	TS2 output OFF time Setting range: 00:00 to 99:59 (Time unit follows the selection in [Step time unit].) Available when  (Time signal output) is selected in [Event output EV2 allocation].	
	TS2 output ON time Setting range: 00:00 to 99:59 (Time unit follows the selection in [Step time unit].) Available when  (Time signal output) is selected in [Event output EV2 allocation].	
	EV3 alarm value Setting range: Same as those of EV1 alarm value. Available when  (High limit alarm) to  (High/Low limits with standby independent alarm) is selected in [Event output EV3 allocation].	
	EV3 high limit alarm value Setting range: Same as those of EV1 alarm value. Available when  (High/Low limits independent alarm),  (High/Low limit range independent alarm) or  (High/Low limits with standby independent alarm) is selected in [Event output EV3 allocation].	
	TS3 output OFF time Setting range: 00:00 to 99:59 (Time unit follows the selection in [Step time unit].) Available when  (Time signal output) is selected in [Event output EV3 allocation].	
	TS3 output ON time Setting range: 00:00 to 99:59 (Time unit follows the selection in [Step time unit].) Available when  (Time signal output) is selected in [Event output EV3 allocation].	







13.4 Control Parameter Setting Mode

Characters, Factory Default	Setting Item, Setting Range	Data
AT00 0 ----	AT Perform/Cancel	
	---- AT Cancel	
	AT00 AT Perform	
PBLT 0 0001	PID block number 1 to 10	
P000 1 0010	OUT1 proportional band Setting range: Thermocouple, RTD input without decimal point: 0 to input span°C (°F) Thermocouple, RTD input with decimal point: 0.0 to input span°C (°F) DC voltage, current inputs: 0.0 to 1000.0%	
I 0000 1 0200	Integral time Setting range: 0 to 3600 seconds	
d0000 1 0050	Derivative time Setting range: 0 to 1800 seconds	
AR 50 1 0050	ARW Setting range: 0 to 100%	
c 0000 0 0003	OUT1 proportional cycle Setting range: 0.5, 1 to 120 seconds Available when OUT1 is relay contact output or non-contact voltage output type.	
HY 50 0 0010	OUT1 ON/OFF hysteresis Setting range: 0.1 to 1000.0°C (°F) DC voltage, current inputs: 1 to 10000 (The placement of the decimal point follows the selection.)	
oLH0 0 0100	OUT1 high limit Setting range: OUT1 low limit to 100% Direct current output type: OUT1 low limit to 105%	
oLL0 0 0000	OUT1 low limit Setting range: 0% to OUT1 high limit Direct current output type: -5% to OUT1 high limit	
orAR 0 0000	OUT1 rate-of-change Setting range: 0 to 100 %/sec	
cAct 0 AR 00	OUT2 cooling method	
	AR 00 Air cooling (Linear characteristics)	
	oL 00 Oil cooling (1.5th power of the linear characteristics)	
	oA 00 Water cooling (2nd power of the linear characteristics)	
Available when EV2 option (if "0020 Heating/Cooling control output" is selected in [Event output EV2 allocation]) is ordered, or when DS, DA or EV3D□ option is ordered.		

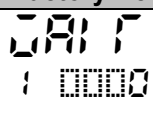
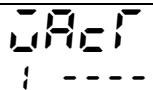
Characters, Factory Default	Setting Item, Setting Range	Data
P_b0 1 00 10	OUT2 proportional band Setting range: Thermocouple, RTD input without decimal point: 0 to Input span°C (°F) Thermocouple, RTD input with decimal point: 0.0 to Input span°C (°F) DC voltage, current inputs: 0.0 to 1000.0% Available when EV2 option (if "OUT2 Heating/Cooling control output" is selected in [Event output EV2 allocation]) is ordered, or when DS, DA or EV3D□ option is ordered.	
c_b0 0 0003	OUT2 proportional cycle Setting range: 0.5, 1 to 120 seconds Available when EV2 option (if "OUT2 Heating/Cooling control output" is selected in [Event output EV2 allocation]) is ordered, or when DS, EV3(DR), EV3DS option is ordered.	
H95b 0 00 10	OUT2 ON/OFF hysteresis Setting range: 0.1 to 1000.0°C (°F) DC voltage, current inputs: 1 to 10000 (The placement of the decimal point follows the selection.) Available when EV2 option (if "OUT2 Heating/Cooling control output" is selected in [Event output EV2 allocation]) is ordered, or when DS, DA or EV3D□ option is ordered.	
oLHb 0 0 100	OUT2 high limit Setting range: OUT2 low limit value to 100% Direct current output type (DA, EV3DA options): OUT2 low limit value to 105% Available when EV2 option (if "OUT2 Heating/Cooling control output" is selected in [Event output EV2 allocation]) is ordered, or when DS, DA or EV3D□ option is ordered.	
oLlb 0 0000	OUT2 low limit Setting range: 0% to OUT2 high limit value Direct current output type (DA, EV3DA options): -5% to OUT2 high limit value Available when EV2 option (if "OUT2 Heating/Cooling control output" is selected in [Event output EV2 allocation]) is ordered, or when DS, DA or EV3D□ option is ordered.	
db00 0 0000	Overlap/Dead band Setting range: -200.0 to 200.0 °C(°F) DC voltage, current inputs: -2000 to 2000 (The placement of the decimal point follows the selection.) Available when EV2 option (if "OUT2 Heating/Cooling control output" is selected in [Event output EV2 allocation]) is ordered, or when DS, DA or EV3D□ option is ordered.	
coar 0 HEAT	Direct/Reverse action	
	HEAT	Reverse (Heating) action
	COOL	Direct (Cooling) action

Characters, Factory Default	Setting Item, Setting Range	Data
<p>H 100 0 0000 H 100 and CT1 current value are alternately indicated.</p>	<p>Heater burnout alarm 1 value Setting range: 20 A: 0.0 to 20.0 A 100 A: 0.0 to 100.0 A Available when C5W, EIW, W option is ordered, and OUT1 is relay contact output or non-contact voltage output type.</p>	
<p>H200 0 0000 H200 and CT2 current value are alternately indicated.</p>	<p>Heater burnout alarm 2 value Setting range: 20 A: 0.0 to 20.0 A 100 A: 0.0 to 100.0 A Available when C5W, EIW, W option is ordered, and OUT1 is relay contact output or non-contact voltage output type.</p>	
<p>LP_T 0 0000</p>	<p>Loop break alarm time Setting range: 0 to 200 minutes Available when 00 14 (Loop break alarm output) is selected in [Event output EV□ allocation].</p>	
<p>LP_H 0 0000</p>	<p>Loop break alarm span Setting range: Thermocouple, RTD input without decimal point: 0 to 150°C (°F) Thermocouple, RTD input with decimal point: 0.0 to 150.0°C (°F) DC voltage, current inputs: 0 to 1500 (The placement of the decimal point follows the selection.) Available when 00 14 (Loop break alarm output) is selected in [Event output EV□ allocation].</p>	

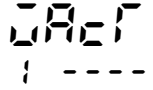
13.5 Wait Parameter Setting Mode

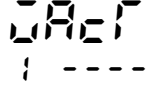
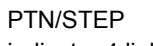
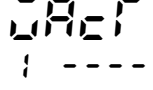
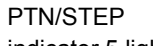
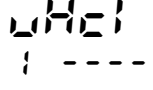
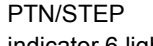
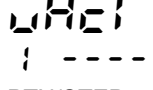
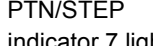
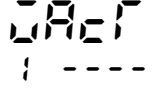
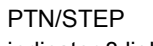
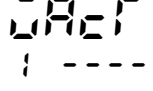
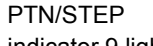
Characters, Factory Default	Setting Item, Setting Range	Data
	Wait value Setting range: 0 to 20% of input span (*) (*) DC voltage, current inputs: 0 to 20% of scaling span (The placement of the decimal point follows the selection.)	
 PTN/STEP indicator 1 lights up.	Step 1 wait function Enabled/Disabled	
	---- Disabled  Enabled	
	Not available if Wait value is set to 0 or 0.0.	
 PTN/STEP indicator 2 lights up.	Step 2 wait function Enabled/Disabled	
	---- Disabled  Enabled	
	Not available if Wait value is set to 0 or 0.0.	
 PTN/STEP indicator 3 lights up.	Step 3 wait function Enabled/Disabled	
	---- Disabled  Enabled	
	Not available if Wait value is set to 0 or 0.0.	
 PTN/STEP indicator 4 lights up.	Step 4 wait function Enabled/Disabled	
	---- Disabled  Enabled	
	Not available if Wait value is set to 0 or 0.0.	
 PTN/STEP indicator 5 lights up.	Step 5 wait function Enabled/Disabled	
	---- Disabled  Enabled	
	Not available if Wait value is set to 0 or 0.0.	
 PTN/STEP indicator 6 lights up.	Step 6 wait function Enabled/Disabled	
	---- Disabled  Enabled	
	Not available if Wait value is set to 0 or 0.0.	
 PTN/STEP indicator 7 lights up.	Step 7 wait function Enabled/Disabled	
	---- Disabled  Enabled	
	Not available if Wait value is set to 0 or 0.0.	
 PTN/STEP indicator 8 lights up.	Step 8 wait function Enabled/Disabled	
	---- Disabled  Enabled	
	Not available if Wait value is set to 0 or 0.0.	
 PTN/STEP indicator 9 lights up.	Step 9 wait function Enabled/Disabled	
	---- Disabled  Enabled	
	Not available if Wait value is set to 0 or 0.0.	

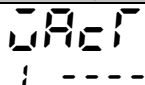
Characters, Factory Default	Setting Item, Setting Range		Data	
 PTN/STEP indicator 10 lights up.	Step 10 wait function Enabled/Disabled			
	----	Disabled		
	USE	Enabled		
	Not available if Wait value is set to 0 or 0.0.			

13.6 Engineering Setting Mode 1

Characters, Factory Default	Setting Item, Setting Range			Data
Lock 0 ----	Set value lock			
			Change via Keypad	Change via Software Communication
	----	Unlock	All set values can be changed.	All set values can be changed.
	Loc 1	Lock 1	Only 'Set value lock' can be changed.	
	Loc 2	Lock 2	Setting items selected in [Changeable in Set value lock] can be changed. Only 'Set value lock' can be changed.	Setting items – except Input type – can be changed temporarily via software communication. However, if power is turned ON again, the set values revert to the values before Lock 3, 4 or 5 was selected.
	Loc 3	Lock 3	All set values can be changed.	
	Loc 4	Lock 4	Only 'Set value lock' can be changed. Other setting items cannot be changed.	
Loc 5	Lock 5	Setting items selected in [Changeable in Set value lock] can be changed. Only 'Set value lock' can be changed.		
LoSE 0 5800	Changeable in Set value lock			
	5800	Step SV, Step time can be changed.		
	58E8	Step SV, Step time, EV <input type="checkbox"/> alarm value can be changed.		
So60 0 1000	Sensor correction coefficient Setting range: -10.000 to 10.000			
So00 0 0000	Sensor correction Setting range: -1000.0 to 1000.0°C (°F) DC voltage, current inputs: -10000 to 10000 (The placement of the decimal point follows the selection.)			
FlLT 0 0000	PV filter time constant Setting range: 0.0 to 10.0 seconds			
cnSL 0 noAL	Communication protocol			
	noAL	Shinko protocol		
	58F0	SV digital transmission (Shinko protocol)		
	58Fr	SV digital reception (Shinko protocol)		
	nodA	Modbus ASCII mode		
	nodr	Modbus RTU mode		
Available when C5W or C5 option is ordered.				

Characters, Factory Default	Setting Item, Setting Range	Data
cāno 0 0000	Instrument number Setting range: 0 to 95 Available when C5W or C5 option is ordered.	
cāSP 0 0096	Communication speed	
	0096 9600 bps	
	0192 19200 bps	
	0384 38400 bps	
	Available when C5W or C5 option is ordered.	
cāFI 0 7E8n	Data bit/Parity	
	8non 8 bits/No parity	
	7non 7 bits/No parity	
	8E8n 8 bits/Even	
	7E8n 7 bits/Even	
	8odd 8 bits/Odd	
	7odd 7 bits/Odd	
	Available when C5W or C5 option is ordered.	
cāSI 0 0001	Stop bit	
	0001 1 bit	
	0002 2 bits	
	Available when C5W or C5 option is ordered.	
cād4 0 0010	Response delay time Setting range: 0 to 1000 ms Available when C5W or C5 option is ordered.	
5b_b 0 0000	SVTC bias Setting range: ±20% of input span DC voltage, current inputs: ±20% of scaling span (The placement of the decimal point follows the selection.) Available when C5W, C5 option is ordered, or when 5b7r [SV digital reception (Shinko protocol)] is selected in [Communication protocol].	

13.7 Engineering Setting Mode 2

Characters, Factory Default	Setting Item, Setting Range		Data
SEnS 0 1370	Input type		
	1370C	K -200 to 1370 °C	
	1370.0C	K -200.0 to 400.0 °C	
	1370J	J -200 to 1000 °C	
	1370R	R 0 to 1760 °C	
	1370S	S 0 to 1760 °C	
	1370B	B 0 to 1820 °C	
	1370E	E -200 to 800 °C	
	1370.0T	T -200.0 to 400.0 °C	
	1370N	N -200 to 1300 °C	
	1370PL2C	PL-II 0 to 1390 °C	
	1370C(W/Re5-26)	C(W/Re5-26) 0 to 2315 °C	
	1370Pt100	Pt100 -200.0 to 850.0 °C	
	1370JPt100	JPt100 -200.0 to 500.0 °C	
	1370Pt100	Pt100 -200 to 850 °C	
	1370JPt100	JPt100 -200 to 500 °C	
	1370K	K -328 to 2498 °F	
	1370.0K	K -328.0 to 752.0 °F	
	1370J	J -328 to 1832 °F	
	1370R	R 32 to 3200 °F	
	1370S	S 32 to 3200 °F	
	1370B	B 32 to 3308 °F	
	1370E	E -328 to 1472 °F	
	1370.0T	T -328.0 to 752.0 °F	
	1370N	N -328 to 2372 °F	
	1370PL2F	PL-II 32 to 2534 °F	
	1370C(W/Re5-26)	C(W/Re5-26) 32 to 4199 °F	
	1370Pt100	Pt100 -328.0 to 1562.0 °F	
	1370JPt100	JPt100 -328.0 to 932.0 °F	
	1370Pt100	Pt100 -328 to 1562 °F	
	1370JPt100	JPt100 -328 to 932 °F	
	420A	4 to 20 mA -2000 to 10000	
020A	0 to 20 mA -2000 to 10000		
001V	0 to 1 V -2000 to 10000		
005V	0 to 5 V -2000 to 10000		
105V	1 to 5 V -2000 to 10000		
010V	0 to 10 V -2000 to 10000		
SEnS 0 1370	Scaling high limit Setting range: Scaling low limit to Input range high limit DC voltage, current inputs: -2000 to 10000 (The placement of the decimal point follows the selection.)		

Characters, Factory Default	Setting Item, Setting Range	Data																																								
S L L 0 -200	Scaling low limit Setting range: Input range low limit to Scaling high limit DC voltage, current inputs: -2000 to 10000 (The placement of the decimal point follows the selection.)																																									
d P 0 0 0 0000	Decimal point place <table border="1"> <tr> <td>0000</td> <td>No decimal point</td> </tr> <tr> <td>0000</td> <td>1 digit after decimal point</td> </tr> <tr> <td>0000</td> <td>2 digits after decimal point</td> </tr> <tr> <td>0000</td> <td>3 digits after decimal point</td> </tr> </table> Available when DC voltage or current input is selected in [Input type].	0000	No decimal point	0000	1 digit after decimal point	0000	2 digits after decimal point	0000	3 digits after decimal point																																	
0000	No decimal point																																									
0000	1 digit after decimal point																																									
0000	2 digits after decimal point																																									
0000	3 digits after decimal point																																									
E H 0 1 0 0000	Event output EV1 allocation <table border="1"> <tr> <td>0000</td> <td>No event</td> </tr> <tr> <td>0001</td> <td>Alarm output, High limit alarm</td> </tr> <tr> <td>0002</td> <td>Alarm output, Low limit alarm</td> </tr> <tr> <td>0003</td> <td>Alarm output, High/Low limits alarm</td> </tr> <tr> <td>0004</td> <td>Alarm output, High/Low limits independent alarm</td> </tr> <tr> <td>0005</td> <td>Alarm output, High/Low limit range alarm</td> </tr> <tr> <td>0006</td> <td>Alarm output, High/Low limit range independent alarm</td> </tr> <tr> <td>0007</td> <td>Alarm output, Process high alarm</td> </tr> <tr> <td>0008</td> <td>Alarm output, Process low alarm</td> </tr> <tr> <td>0009</td> <td>Alarm output, High limit with standby alarm</td> </tr> <tr> <td>0010</td> <td>Alarm output, Low limit with standby alarm</td> </tr> <tr> <td>0011</td> <td>Alarm output, High/Low limits with standby alarm</td> </tr> <tr> <td>0012</td> <td>Alarm output, High/Low limits with standby independent alarm</td> </tr> <tr> <td>0013</td> <td>Heater burnout alarm output (When C5W, EIW or W option is ordered)</td> </tr> <tr> <td>0014</td> <td>Loop break alarm output</td> </tr> <tr> <td>0015</td> <td>Time signal output</td> </tr> <tr> <td>0016</td> <td>Output during AT</td> </tr> <tr> <td>0017</td> <td>Pattern end output</td> </tr> <tr> <td>0018</td> <td>Output by communication command</td> </tr> <tr> <td>0019</td> <td>RUN output</td> </tr> </table> <p>When 0001 (High limit alarm) to 0012 (High/Low limit with standby independent alarm) or 0015 (Time signal output) is selected, one output can be set to one event output.</p> <p>When 0013 (Heater burnout alarm output), 0014 (Loop break alarm), 0016 (Output during AT) to 0019 (RUN output) are selected, each output is common to multiple event outputs.</p>	0000	No event	0001	Alarm output, High limit alarm	0002	Alarm output, Low limit alarm	0003	Alarm output, High/Low limits alarm	0004	Alarm output, High/Low limits independent alarm	0005	Alarm output, High/Low limit range alarm	0006	Alarm output, High/Low limit range independent alarm	0007	Alarm output, Process high alarm	0008	Alarm output, Process low alarm	0009	Alarm output, High limit with standby alarm	0010	Alarm output, Low limit with standby alarm	0011	Alarm output, High/Low limits with standby alarm	0012	Alarm output, High/Low limits with standby independent alarm	0013	Heater burnout alarm output (When C5W, EIW or W option is ordered)	0014	Loop break alarm output	0015	Time signal output	0016	Output during AT	0017	Pattern end output	0018	Output by communication command	0019	RUN output	
0000	No event																																									
0001	Alarm output, High limit alarm																																									
0002	Alarm output, Low limit alarm																																									
0003	Alarm output, High/Low limits alarm																																									
0004	Alarm output, High/Low limits independent alarm																																									
0005	Alarm output, High/Low limit range alarm																																									
0006	Alarm output, High/Low limit range independent alarm																																									
0007	Alarm output, Process high alarm																																									
0008	Alarm output, Process low alarm																																									
0009	Alarm output, High limit with standby alarm																																									
0010	Alarm output, Low limit with standby alarm																																									
0011	Alarm output, High/Low limits with standby alarm																																									
0012	Alarm output, High/Low limits with standby independent alarm																																									
0013	Heater burnout alarm output (When C5W, EIW or W option is ordered)																																									
0014	Loop break alarm output																																									
0015	Time signal output																																									
0016	Output during AT																																									
0017	Pattern end output																																									
0018	Output by communication command																																									
0019	RUN output																																									
A 1 E A 0 n o 0 0	EV1 alarm value 0 Enabled/Disabled <table border="1"> <tr> <td>n o 0 0</td> <td>Disabled</td> </tr> <tr> <td>y e s 0</td> <td>Enabled</td> </tr> </table> Available when any alarm from 0001 (High limit alarm) to 0012 (High/Low limits with standby independent alarm) is selected in [Event output EV1 allocation] - excluding 0007 (Process high alarm) and 0008 (Process low alarm).	n o 0 0	Disabled	y e s 0	Enabled																																					
n o 0 0	Disabled																																									
y e s 0	Enabled																																									

Characters, Factory Default	Setting Item, Setting Range	Data																																										
A 1H4 0 00 0	EV1 alarm hysteresis Setting range: 0.1 to 1000.0°C (°F) DC voltage, current inputs: 1 to 10000 (The placement of the decimal point follows the selection.) Available when any alarm from 000 1 (High limit alarm) to 00 12 (High/Low limits with standby independent alarm) is selected in [Event output EV1 allocation].																																											
A 1d4 0 0000	EV1 alarm delay time Setting range: 0 to 10000 seconds Available when any alarm from 000 1 (High limit alarm) to 00 12 (High/Low limits with standby independent alarm) is selected in [Event output EV1 allocation].																																											
A 1L A 0 000L	EV1 alarm Energized/De-energized <table border="1"> <tr> <td>000L</td> <td>Energized</td> </tr> <tr> <td>000S</td> <td>De-energized</td> </tr> </table> Available when any alarm from 000 1 (High limit alarm) to 00 12 (High/Low limits with standby independent alarm) is selected in [Event output EV1 allocation].	000L	Energized	000S	De-energized																																							
000L	Energized																																											
000S	De-energized																																											
E002 0 0000	Event output EV2 allocation <table border="1"> <tr> <td>0000</td> <td>No event</td> </tr> <tr> <td>0001</td> <td>Alarm output, High limit alarm</td> </tr> <tr> <td>0002</td> <td>Alarm output, Low limit alarm</td> </tr> <tr> <td>0003</td> <td>Alarm output, High/Low limits alarm</td> </tr> <tr> <td>0004</td> <td>Alarm output, High/Low limits independent alarm</td> </tr> <tr> <td>0005</td> <td>Alarm output, High/Low limit range alarm</td> </tr> <tr> <td>0006</td> <td>Alarm output, High/Low limit range independent alarm</td> </tr> <tr> <td>0007</td> <td>Alarm output, Process high alarm</td> </tr> <tr> <td>0008</td> <td>Alarm output, Process low alarm</td> </tr> <tr> <td>0009</td> <td>Alarm output, High limit with standby alarm</td> </tr> <tr> <td>00 10</td> <td>Alarm output, Low limit with standby alarm</td> </tr> <tr> <td>00 11</td> <td>Alarm output, High/Low limits with standby alarm</td> </tr> <tr> <td>00 12</td> <td>Alarm output, High/Low limits with standby independent alarm</td> </tr> <tr> <td>00 13</td> <td>Heater burnout alarm output (When C5W, EIW or W option is ordered)</td> </tr> <tr> <td>00 14</td> <td>Loop break alarm output</td> </tr> <tr> <td>00 15</td> <td>Time signal output</td> </tr> <tr> <td>00 16</td> <td>Output during AT</td> </tr> <tr> <td>00 17</td> <td>Pattern end output</td> </tr> <tr> <td>00 18</td> <td>Output by communication command</td> </tr> <tr> <td>00 19</td> <td>RUN output</td> </tr> <tr> <td>0020</td> <td>Heating/Cooling control Relay contact output</td> </tr> </table> When 000 1 (High limit alarm) to 00 12 (High/Low limit with standby independent alarm) or 00 15 (Time signal output) is selected, one output can be set to one event output. When 00 13 (Heater burnout alarm output), 00 14 (Loop break alarm), 00 16 (Output during AT) to 00 19 (RUN output) are selected, each output is common to multiple event outputs. Available when the EV2 or EV3(DR) option is ordered.	0000	No event	0001	Alarm output, High limit alarm	0002	Alarm output, Low limit alarm	0003	Alarm output, High/Low limits alarm	0004	Alarm output, High/Low limits independent alarm	0005	Alarm output, High/Low limit range alarm	0006	Alarm output, High/Low limit range independent alarm	0007	Alarm output, Process high alarm	0008	Alarm output, Process low alarm	0009	Alarm output, High limit with standby alarm	00 10	Alarm output, Low limit with standby alarm	00 11	Alarm output, High/Low limits with standby alarm	00 12	Alarm output, High/Low limits with standby independent alarm	00 13	Heater burnout alarm output (When C5W, EIW or W option is ordered)	00 14	Loop break alarm output	00 15	Time signal output	00 16	Output during AT	00 17	Pattern end output	00 18	Output by communication command	00 19	RUN output	0020	Heating/Cooling control Relay contact output	
0000	No event																																											
0001	Alarm output, High limit alarm																																											
0002	Alarm output, Low limit alarm																																											
0003	Alarm output, High/Low limits alarm																																											
0004	Alarm output, High/Low limits independent alarm																																											
0005	Alarm output, High/Low limit range alarm																																											
0006	Alarm output, High/Low limit range independent alarm																																											
0007	Alarm output, Process high alarm																																											
0008	Alarm output, Process low alarm																																											
0009	Alarm output, High limit with standby alarm																																											
00 10	Alarm output, Low limit with standby alarm																																											
00 11	Alarm output, High/Low limits with standby alarm																																											
00 12	Alarm output, High/Low limits with standby independent alarm																																											
00 13	Heater burnout alarm output (When C5W, EIW or W option is ordered)																																											
00 14	Loop break alarm output																																											
00 15	Time signal output																																											
00 16	Output during AT																																											
00 17	Pattern end output																																											
00 18	Output by communication command																																											
00 19	RUN output																																											
0020	Heating/Cooling control Relay contact output																																											

Characters, Factory Default	Setting Item, Setting Range	Data
A23A 0 no00	EV2 alarm value 0 Enabled/Disabled	
	no00 Disabled	
	yes0 Enabled	
	Available when any alarm from 0001 (High limit alarm) to 0012 (High/Low limits with standby independent alarm) is selected in [Event output EV2 allocation] - excluding 0007 (Process high alarm) and 0008 (Process low alarm).	
A24Y 0 0010	EV2 alarm hysteresis Setting range: 0.1 to 1000.0°C (°F), DC voltage, current inputs: 1 to 10000 (The placement of the decimal point follows the selection.) Available when any alarm from 0001 (High limit alarm) to 0012 (High/Low limits with standby independent alarm) is selected in [Event output EV2 allocation].	
A24Y 0 0000	EV2 alarm delay time Setting range: 0 to 10000 seconds Available when any alarm from 0001 (High limit alarm) to 0012 (High/Low limits with standby independent alarm) is selected in [Event output EV2 allocation].	
A2LA 0 no0L	EV2 alarm Energized/De-energized	
	no0L Energized	
	re05 De-energized	
	Available when any alarm from 0001 (High limit alarm) to 0012 (High/Low limits with standby independent alarm) is selected in [Event output EV2 allocation].	
E603 0 0000	Event output EV3 allocation	
	0000 No event	
	0001 Alarm output, High limit alarm	
	0002 Alarm output, Low limit alarm	
	0003 Alarm output, High/Low limits alarm	
	0004 Alarm output, High/Low limits independent alarm	
	0005 Alarm output, High/Low limit range alarm	
	0006 Alarm output, High/Low limit range independent alarm	
	0007 Alarm output, Process high alarm	
	0008 Alarm output, Process low alarm	
	0009 Alarm output, High limit with standby alarm	
	0010 Alarm output, Low limit with standby alarm	
	0011 Alarm output, High/Low limits with standby alarm	
	0012 Alarm output, High/Low limits with standby independent alarm	
	0013 Heater burnout alarm output (When C5W, EIW or W option is ordered)	
	0014 Loop break alarm output	
	0015 Time signal output	
	0016 Output during AT	
	0017 Pattern end output	
	0018 Output by communication command	
0019 RUN output		
	When 0001 (High limit alarm) to 0012 (High/Low limit with standby independent alarm) or 0015 (Time signal output) is selected, one output can be set to one event output. When 0013 (Heater burnout alarm output), 0014 (Loop break alarm), 0016 (Output during AT) to 0019 (RUN output) are selected, each output is common to multiple event outputs. Available when the EV3D□ or EI option is ordered.	

Characters, Factory Default	Setting Item, Setting Range			Data
A3EA 0 0000	EV3 alarm value 0 Enabled/Disabled			
	no00	Disabled		
	YES0	Enabled		
	Available when any alarm from 000 1 (High limit alarm) to 00 12 (High/Low limits with standby independent alarm) is selected in [Event output EV3 allocation] - excluding 0007 (Process high alarm) and 0008 (Process low alarm).			
A3HY 0 00 0	EV3 alarm hysteresis			
	Setting range: 0.1 to 1000.0°C (°F), DC voltage, current inputs: 1 to 10000 (The placement of the decimal point follows the selection.) Available when any alarm from 000 1 (High limit alarm) to 00 12 (High/Low limits with standby independent alarm) is selected in [Event output EV3 allocation].			
A3dY 0 0000	EV3 alarm delay time			
	Setting range: 0 to 10000 seconds Available when any alarm from 000 1 (High limit alarm) to 00 12 (High/Low limits with standby independent alarm) is selected in [Event output EV3 allocation].			
A3LA 0 000L	EV3 alarm Energized/De-energized			
	no0L	Energized		
	rEB5	De-energized		
	Available when any alarm from 000 1 (High limit alarm) to 00 12 (High/Low limits with standby independent alarm) is selected in [Event output EV3 allocation].			
E6I 1 0 0000	Event input DI1 allocation			
		Event input function	Input ON (Closed)	Input OFF (Open)
	0000	No event		
	000 1	Pattern number selection		
	0002	Direct/Reverse action	Direct action	Reverse action
	0003	Program control RUN/STOP	RUN	STOP
	0004	Program control Holding/Not holding	Holding	Not holding
	0005	Program control Advance function	Advance function	Usual control
	Available when C5W, EIW, EIT, C5 or EI option is ordered.			

Characters, Factory Default	Setting Item, Setting Range			Data	
Ei 2 0 0000	Event input DI2 allocation				
		Event input function	Input ON (Closed)		Input OFF (Open)
	0000	No event			
	0001	Pattern number selection			
	0002	Direct/Reverse action	Direct action		Reverse action
	0003	Program control RUN/STOP	RUN		STOP
	0004	Program control Holding/Not holding	Holding		Not holding
	0005	Program control Advance function	Advance function		Usual control
Available when C5W, EIW, EIT, C5 or EI option is ordered.					
Tr 5 0 P800	Transmission output type				
	P800	PV transmission			
	S800	SV transmission			
	A800	MV transmission			
Available when EIT option is ordered.					
Tr LH 0 1370	Transmission output high limit				
	Setting range: PV, SV transmission: Transmission output low limit to Input range high limit Direct current, voltage inputs: -2000 to 10000 (The placement of the decimal point follows the selection.) MV transmission: Transmission output low limit to 105.0% Available when EIT option is ordered.				
Tr LL 0 -200	Transmission output low limit				
	Setting range: PV, SV transmission: Input range low limit to Transmission output high limit Direct current, voltage inputs: -2000 to 10000 (The placement of the decimal point follows the selection.) MV transmission: -5.0% to Transmission output high limit Available when EIT option is ordered.				
A.50 0 A.00	Step time unit				
	A.00	Hours : Minutes			
	5E.00	Minutes : Seconds			

Characters, Factory Default	Setting Item, Setting Range	Data
P_rEt 0 stop	Power restore action	
	stop	Stops after power is restored. After power is restored, stops current program control, and returns to the program control STOP (in Standby).
	conf	Continues (resumes) after power is restored. Continues (resumes) previous program control after power is restored.
	Hold	Suspends after power is restored. After power is restored, suspends (on hold) current program control, and performs Fixed value control using the step SV at the time of suspension. Pressing the [RUN] key cancels suspension, and Program control resumes.
S_Sd 0 0000	Step SV when program control starts Setting range: Scaling low limit to Scaling high limit (The placement of the decimal point follows the selection.)	
S_SL 0 P800	Program control start type	
	P800	PV start: Only when Program control starts, the step SV and step time are advanced to the PV, then Program control starts.
	P8r0	PVR start: When Program control starts and in pattern repeating, the step SV and step time are advanced to the PV, then Program control starts.
S800	SV start: When Program control starts, the Program control starts from the step SV set in [Step SV when program control starts].	
PEtA 0 0000	Pattern end output time Setting range: 0 to 10000 seconds	
AT_b 0 0020	AT bias Setting range: Thermocouple, RTD inputs without decimal point: 0 to 50°C (0 to 100°F) Thermocouple, RTD inputs with decimal point: 0.0 to 50.0°C (0.0 to 100.0°F) Available when Thermocouple or RTD input is selected in [Input type].	
EoUt 0 oFF0	Output status when input errors occur	
	oFF0	Output OFF
	oN00	Output ON
Available for direct current and voltage inputs, and direct current output.		

Characters, Factory Default	Setting Item, Setting Range	Data
	Indication time Setting range: 00:00 to 60:00 (Minutes : Seconds) When set to 00:00, Displays remain ON.	
	Error indication	
	Disabled	
	Enabled	

13.8 Data Clear

Characters, Factory Default	Setting Item, Setting Range	Data
	Data clear Yes/No	
	Data clear No	
	Data clear Yes	

14. Making Program Pattern Table and Data Table

Before setting program, make a program pattern table and data table.

14.1 Making Program Pattern Table

Please make a copy of the program pattern table (p.162), and follow the procedure below.

(1) Write a step SV, step time, PID block number, Wait function Enabled/Disabled for each step from Step 1 in numerical order.

(Even if the same block number is used, write it for every step.)

(2) Draw a line graph of step SV.

Program Pattern Table

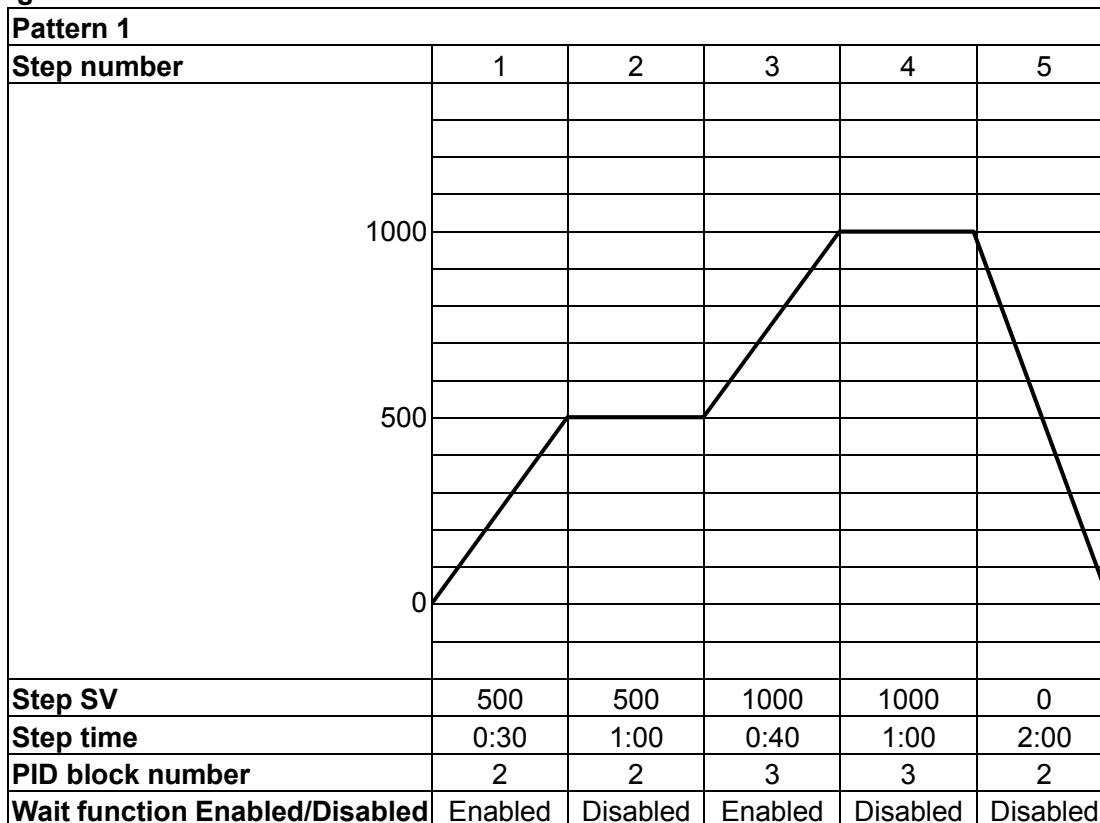

(Fig. 14.1-1)

Explanation of Program Pattern Table

Program pattern table consists of Y axis which represents the step SV (°C, °F), and X axis which represents the step time (Hours : Minutes, Minutes : Seconds).

Step SV is considered to be the SV at the end of the step.

Step time is considered to be the step process time.

- The relation between the step SV and step time can be explained as follows.

Step 1: The control is performed so that the temperature reaches from 0 to 500°C for 30 minutes.

Depending on the selection in [Program control start type], control is performed as follows.

- When SV start is selected: Performs control from the step SV set in [Step SV when program control starts] so that the temperature reaches 500°C.
- When PV start or PVR start is selected: Step SV and time are advanced to PV, and control starts so that the temperature reaches 500°C.

Step 2: The control is performed so that SV is maintained at 500°C for 1 hour.

Step 3: The control is performed so that SV rises from 500°C to 1000°C for 40 minutes.

Step 4: The control is performed so that SV is maintained at 1000°C for 1 hour.

Step 5: The control is performed so that SV drops from 1000°C to 0°C for 2 hours.

- PID block includes: OUT1 proportional band, Integral time, Derivative time, ARW, OUT2 proportional band
10 types of PID block (1 – 10) can be set.
- Wait function Enabled or Disabled can be selected for each step.

14.2 Making Data Table

Please make a copy of Data Table (p.163), and follow the procedure below.

- (1) Write data for block numbers in Control parameter setting mode, by referring to the PID block numbers in the Program pattern table.
- (2) For Wait value and other setting items, write the data in the table if required.

About PID block settings

If program pattern is not set for a step, its PID block number becomes 1 (factory default). We highly recommend that you leave the factory default values of PID block 1 as they are, and set the values from PID block 2.

• Example of PID block setting

PID Block number	OUT1 P-band	Integral time	Derivative time	ARW	OUT2 P-band
1	10°C	200 sec	50 sec	50%	10°C
2	30°C	240 sec	60 sec	35%	10°C
3	50°C	340 sec	85 sec	40%	10°C

• Example of Wait value setting

Wait value	10°C
------------	------

Wait value is common to all steps for each pattern.

• Example of other setting items

Setting items	Data
OUT1 proportional cycle	15 sec
OUT2 proportional cycle	15 sec
Number of repetitions	1
Pattern link	Pattern link Disabled
Communication protocol	Shinko protocol
Instrument number	1
Communication speed	38400 bps
Data bit/Parity	7 bits/Even
Stop bit	1 bit
Response delay time	10 ms

Data Table

Please make a copy of this table for use.

• **PID block**

PID Block number	OUT1 P-band	Integral time	Derivative time	ARW	OUT2 P-band
1		sec	sec	%	
2		sec	sec	%	
3		sec	sec	%	
4		sec	sec	%	
5		sec	sec	%	
6		sec	sec	%	
7		sec	sec	%	
8		sec	sec	%	
9		sec	sec	%	
10		sec	sec	%	

• **Wait value**

Wait value	<input type="text"/>
-------------------	----------------------

Wait value is common to all steps for each pattern.

• **Other setting data** (Please use the blank for your own usage.)

Setting item	Data
OUT1 proportional cycle	sec
OUT2 proportional cycle	sec
Number of repetitions	times
Pattern link	
Communication protocol	
Instrument number	
Communication speed	bps
Data bit/Parity	
Stop bit	
Response delay time	ms

15. Key Operation Flowchart

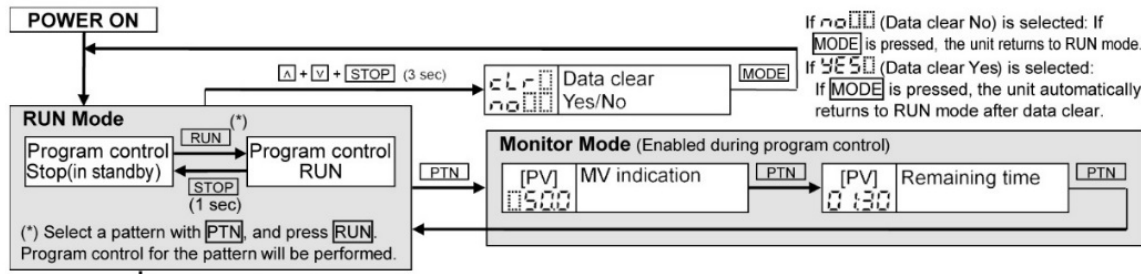

About Setting Item

- **Step 1 SV** (Upper left: PV Display: Indicates setting characters. Lower left: SV Display: Indicates factory default. Right side: Indicates setting items.)
- **EV2 alarm value** (Shaded setting items are optional, and appear only when the options are ordered.)
- (*)1 Available when 001 (High limit) to 012 (H/L limits with standby independent) are selected in [Event output EV allocation].
- (*)2 Available when 004 (H/L limits independent), 006 (H/L limit range independent) or 012 (H/L limits with standby independent) is selected in [Event output EV allocation].
- (*)3 Available when 015 (Time signal output) is selected in [Event output EV allocation].
- (*)4 Available when SV digital reception (Shinko protocol) is selected in [Communication protocol].
- (*)5 Available when direct current or DC voltage input is selected in [Input type].
- (*)6 Available when 001(High limit) to 012 (H/L limits with standby independent) – except [007 (Process high) and 008 (Process low)] – are selected in [Event output EV allocation].

Key Operation

- Use **▲** and **▼** for settings, and register the settings with **MODE** or **DISP**.
- **MODE**: Moves to the next item, illustrated by an arrow.
- **DISP**: Moves back to the previous item (Opposite to **MODE**).
- **MODE** (3 sec): Press **MODE** for approx. 3 seconds.
- **▲+MODE**: Press **▲** and **MODE** (in that order) together.
- **▲+▼** (3 sec): Press **▲** and **▼** (in that order) together for 3 seconds.
- **▼+MODE** (3 sec): Press **▼** and **MODE** (in that order) together for 3 seconds.
- **▲+▼+MODE** (3 sec): Press **▲**, **▼** and **MODE** (in that order) together for 3 seconds.
- **▲+▼+STOP** (3 sec): Press **▲**, **▼** and **STOP** (in that order) together for 3 seconds.
- **RST**: Returns to RUN mode from any setting items.

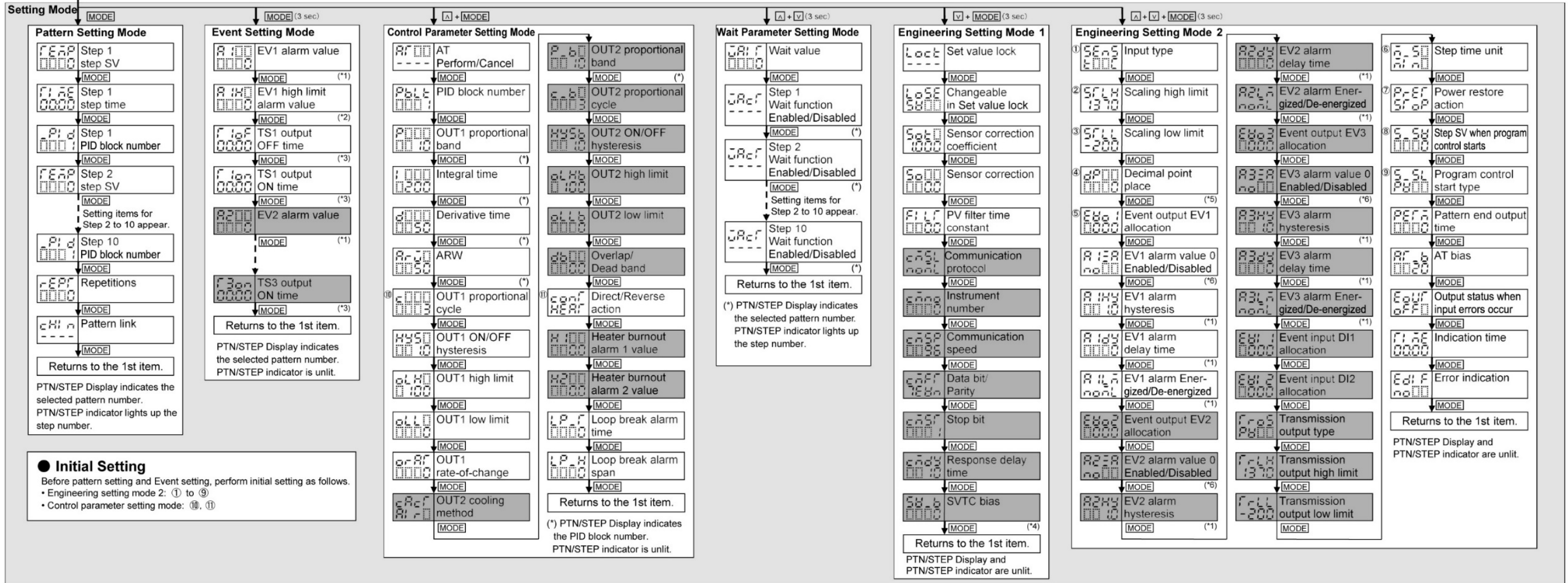

Pattern link	Lock 5	Stop bit	Input type	Temperature	Event output EV1 to EV3 allocation	Power restore action
---- Pattern link Disabled	Changeable in Set value lock	1 bit	K	32 to 3200 °F	Event output EV1 to EV3 allocation	Stops after power is restored
CH: Pattern link Enabled	Step SV + Step time	2 bits	J	32 to 3308 °F	No event	Continues after power is restored
AT Perform / Cancel	Step SV + Step time + EV alarm value	Input type	E	-328 to 1472 °F	High limit alarm	Suspends after power is restored
---- AT Cancel	Step SV + Step time + EV alarm value	Input type	T	-328.0 to 752.0 °F	Low limit alarm	Program control start type
AT Perform	Communication protocol	K	N	-328 to 2372 °F	H/L limits alarm	EV1 to EV3 alarm Energized / De-energized
OUT2 cooling method	Shinko protocol	J	PL-II	32 to 2534 °F	H/L limits independent alarm	Energized
Air cooling	SV digital transmission (Shinko protocol)	R	C(W/Re5-26)	32 to 4199 °F	H/L limit range alarm	De-energized
Oil cooling	SV digital reception (Shinko protocol)	S	Pt100	-328.0 to 1562.0 °F	H/L limit range independent alarm	Event input DI1, DI2 allocation
Water cooling	Modbus ASCII mode	B	JPt100	-328.0 to 932.0 °F	Process high alarm	Output status when input errors occur
Direct / Reverse action	Modbus RTU mode	E	Pt100	-328 to 1562 °F	Process low alarm	Output OFF
Reverse control action	Communication speed	T	JPt100	-328 to 932 °F	High limit with standby alarm	Output ON
Direct control action	9600 bps	N	4-20 mA	-2000 to 10000	Low limit with standby alarm	Error indication
Step 1 to 10 Wait function Enabled / Disabled	19200 bps	PL-II	0-20 mA	-2000 to 10000	H/L limits with standby alarm	Disabled
---- Disabled	38400 bps	C(W/Re5-26)	0-1 V	-2000 to 10000	H/L limits with standby independent	Enabled
USE: Enabled	Data bit / Parity	Pt100	0-5 V	-2000 to 10000	Heater burnout alarm output	Program control Advance function
Set value lock	8 bits / No parity	JPt100	1-5 V	-2000 to 10000	Loop break alarm output	Transmission output type
---- Unlock	7 bits / No parity	Pt100	0-10 V	-2000 to 10000	Time signal output	PV transmission
Lock 1	8 bits / Even	JPt100	0-10 V	-2000 to 10000	Output during AT	SV transmission
Lock 2	7 bits / Even	K	No decimal point	00:00	Pattern end output	MV transmission
Lock 3	8 bits / Odd	K	1 digit after decimal point	00:00	Output by communication command	Step time unit
Lock 4	7 bits / Odd	J	2 digits after decimal point	00:00	RUN output	Hours : Minutes
						Minutes : Seconds

***** Inquiries *****

For any inquiries about this unit, please contact our agency or the vendor where you purchased the unit after checking the following.

[Example]

- Model ----- PCB1R00-52
- Option ----- EV3(DR), C5W(100A)
- Serial number ----- No. 173F05000

In addition to the above, please let us know the details of the malfunction, or discrepancy, and the operating conditions.

SHINKO TECHNOS CO., LTD.
OVERSEAS DIVISION

Head Office : 2-5-1, Senbahigashi, Minoo, Osaka, Japan

URL: <http://www.shinko-technos.co.jp/e/>

E-mail: overseas@shinko-technos.co.jp

Tel : +81-72-727-6100

Fax: +81-72-727-7006