

FREQUENCY TRANSMITTER

SAF SERIES

SAFU

INSTRUCTION MANUAL

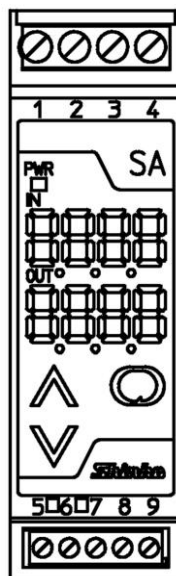

Shinko

Preface

Thank you for purchasing the Frequency Transmitter SAFU.

This manual contains instructions for the mounting, functions, operations and notes when operating the SAFU. To prevent accidents arising from the misuse of this instrument, please ensure the operator receives this manual.

Notes

- This instrument should be used in accordance with the specifications described in the manual. If it is not used according to the specifications, it may malfunction or cause a fire.
- Be sure to follow the warnings, cautions and notices. If they are not observed, serious injury or malfunction may occur.
- Specifications of the SAFU and the contents of this instruction manual are subject to change without notice.
- Care has been taken to assure that the contents of this instruction manual are correct, but if there are any doubts, mistakes or questions, please inform our sales department.
- This instrument is designed to be installed on a DIN rail within a control panel. If it is not, measures must be taken to ensure that the operator does not touch power terminals or other high voltage sections.
- Any unauthorized transfer or copying of this document, in part or in whole, is prohibited.
- Shinko Technos CO., LTD. is not liable for any damage or secondary damage(s) incurred as a result of using this product, including any indirect damage.

SAFETY PRECAUTIONS (Be sure to read these precautions before using our products.)

The safety precautions are classified into categories: "Warning" and "Caution".

Depending on the circumstances, procedures indicated by  Caution may cause serious results, so be sure to follow the directions for usage.



Warning

Procedures which may lead to dangerous conditions and cause death or serious injury, if not carried out properly.



Caution

Procedures which may lead to dangerous conditions and cause superficial to medium injury or physical damage or may degrade or damage the product, if not carried out properly.



Warning

- To prevent an electric shock or fire, only Shinko or other qualified service personnel may handle the inner assembly.
- To prevent an electric shock, fire or damage to the instrument, parts replacement may only be undertaken by Shinko or other qualified service personnel.



Safety precautions

- To ensure safe and correct use, thoroughly read and understand this manual before using this instrument.
- This instrument is intended to be used for industrial machinery, machine tools and measuring equipment. Verify correct usage after consulting purpose of use with our agency or main office. (Never use this instrument for medical purposes with which human lives are involved.)
- External protection devices such as protection equipment against excessive temperature rise, etc. must be installed, as malfunction of this product could result in serious damage to the system or injury to personnel. Also proper periodic maintenance is required.
- This instrument must be used under the conditions and environment described in this manual. Shinko Technos Co., Ltd. does not accept liability for any injury, loss of life or damage occurring due to the instrument being used under conditions not otherwise stated in this manual.

Caution with respect to Export Trade Control Ordinance

To avoid this instrument from being used as a component in, or as being utilized in the manufacture of weapons of mass destruction (i.e. military applications, military equipment, etc.), please investigate the end users and the final use of this instrument.

In the case of resale, ensure that this instrument is not illegally exported.

1. Installation precautions



Caution

This instrument is intended to be used under the following environmental conditions (IEC61010-1): Overvoltage category II, Pollution degree 2

Ensure the mounting location corresponds to the following conditions:

- A minimum of dust, and an absence of corrosive gases
- No flammable, explosive gases
- No mechanical vibrations or shocks
- No exposure to direct sunlight, an ambient temperature of -5 to 55°C (23 to 131°F) that does not change rapidly, and no icing
- An ambient non-condensing humidity of 35 to 85%RH
- No large capacity electromagnetic switches or cables through which large current is flowing
- No water, oil or chemicals or where the vapors of these substances can come into direct contact with the unit
- When installing this unit within a control panel, take note that ambient temperature of this unit as well as the control panel must not exceed 55°C (131°F). Otherwise the life of electronic components (especially electrolytic capacitor) may be shortened.

Note: Avoid setting this instrument directly on or near flammable material even though the case of this instrument is made of flame-resistant resin.

2. Wiring precautions



Caution

- Do not leave bits of wire in the instrument, because they could cause a fire and malfunction.
- When wiring terminals, use ferrules with an insulation sleeve and crimping pliers made by Phoenix Contact GMBH & CO. applicable to terminals.
- Tighten the terminal screw using the specified torque.
If excessive force is applied to the screw when tightening, the screw or case may be damaged.
- This instrument has no built-in power switch, circuit breaker or fuse. It is necessary to install them near the instrument.
(Recommended fuse: Time-lag fuse, rated voltage 250V AC, rated current 2A)
- For wiring of AC power source, be sure to use exclusive terminals as described in this manual. If AC power source is connected to incorrect terminals, the unit will burn out.
- For a 24V DC power source, do not confuse polarity when wiring.
- Do not apply a commercial power source to the sensor connected to the input terminal nor allow the power source to come into contact with the sensor, as the input circuit may burn out.
- Keep the input/output wires and power line separate.

3. Operation and maintenance precautions



Caution

- Do not touch live terminals. This may cause electric shock or problems in operation.
- Turn the power supply to the instrument OFF when retightening the terminal and cleaning. Working or touching the terminal with the power switched ON may result in severe injury or death due to Electric Shock.
- Use a soft, dry cloth when cleaning the instrument.
(Alcohol based substances may tarnish or deface the unit.)
- As the display section is vulnerable, do not strike or scratch it with a hard object or press hard on it.

Characters used in this manual

Indication	<i>1</i>	<i>0</i>	<i>1</i>	<i>2</i>	<i>3</i>	<i>4</i>	<i>5</i>	<i>6</i>	<i>7</i>	<i>8</i>	<i>9</i>	<i>℃</i>	<i>F</i>
Number, °C/F	-1	0	1	2	3	4	5	6	7	8	9	°C	F
Indication	<i>A</i>	<i>b</i>	<i>c</i>	<i>d</i>	<i>E</i>	<i>F</i>	<i>G</i>	<i>H</i>	<i>I</i>	<i>J</i>	<i>k</i>	<i>L</i>	<i>M</i>
Alphabet	A	B	C	D	E	F	G	H	I	J	K	L	M
Indication	<i>n</i>	<i>o</i>	<i>P</i>	<i>q</i>	<i>r</i>	<i>s</i>	<i>T</i>	<i>U</i>	<i>V</i>	<i>W</i>	<i>X</i>	<i>Y</i>	<i>Z</i>
Alphabet	N	O	P	Q	R	S	T	U	V	W	X	Y	Z

□ means that no character is indicated (unlit) on the display.

CONTENTS

	Page
1. Model	5
1.1 Model.....	5
1.2 How to read the model label	5
2. Name and functions of sections	6
3. Mounting	6
3.1 External dimensions (Scale: mm)	6
3.2 Mounting and removal to/from the DIN rail	7
4. Wiring	7
4.1 Recommended ferrules	7
4.2 Terminal arrangement and circuit configuration.....	8
4.3 Wiring of terminals	8
4.3.1 Power source wiring.....	8
4.3.2 Output wiring.....	8
4.3.3 Input wiring.....	8
5. Operation flowchart	9
6. Setup.....	10
6.1 Indication after power-on	10
6.2 Basic setup operation	11
6.3 Setup of the unit.....	11
6.3.1 When using this unit as a standard frequency transmitter.....	13
6.3.2 When using the Reverse function	13
7. Adjustment	14
7.1 Basic operation of adjustment	14
7.2 Adjustment.....	15
8. Unit operation.....	15
8.1 Indication after power-on	15
8.2 Unit operation	16
9. Specifications	16
10. Troubleshooting	18
10.1 Indication	18
10.2 Key operation	19
10.3 Running	19
11. Character table.....	19

1. Model

1.1 Model

SAFU - <input type="checkbox"/> <input type="checkbox"/> - <input type="checkbox"/>		Series name: SAF
Frequency transmitter	1	Ultra low frequency transmitter
	2	Low frequency transmitter (100Hz maximum)
	3	Low frequency transmitter (50Hz minimum)
	4	Frequency transmitter
Input	0	Open collector
	1	Voltage pulse
	2	Line driver
	3	Contact switch (*)
Power supply	0	100 to 240V AC
	1	24V AC/DC

(*) For SAFU-1- (for Ultra low frequency transmitter only)

(Example 1) SAFU-10-0: Frequency: 1000mHz, Scaling: 0 to 1000, Output: 1 to 5V DC
Default value: Input frequency: 9.999Hz

Output: 4 to 20mA DC

Scaling: 0 to 9999

(Example 2) SAFU-20-0: Frequency: 10Hz, Scaling: 0 to 1000, Output: 1 to 5V DC

Default value: Input frequency: 100Hz

Output: 4 to 20mA DC

Scaling: 0 to 9999

(Example 3) SAFU-30-0: Frequency: 1000Hz, Scaling: 0 to 1000, Output: 1 to 5V DC

Default value: Input frequency: 9999Hz

Output: 4 to 20mA DC

Scaling: 0 to 9999

(Example 4) SAFU-40-0: Frequency: 10kHz, Scaling: 0 to 1000, Output: 1 to 5V DC

Default value: Input frequency: 100kHz

Output: 4 to 20mA DC

Scaling: 0 to 9999

1.2 How to read the model label

The model label is attached to the left side of the case.

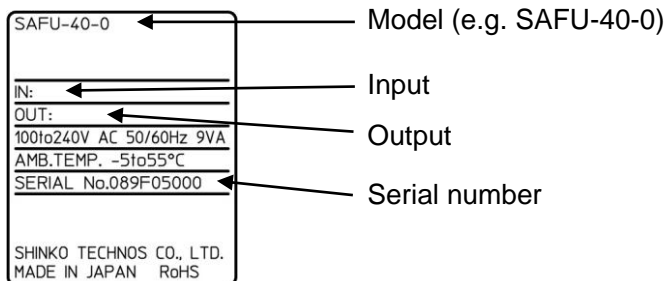

(Fig. 1.2-1)

2. Name and functions of sections

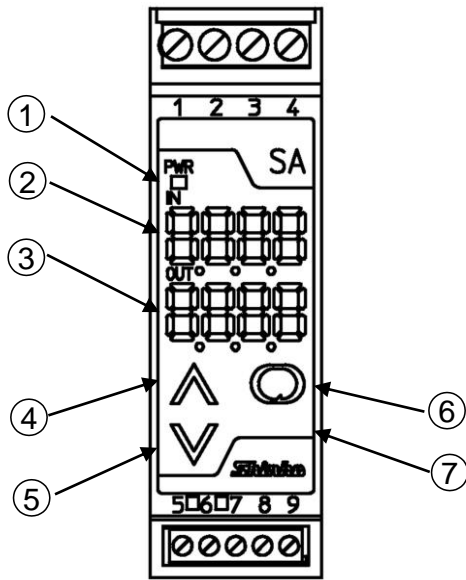

(Fig.2.1)

- ① **Power indicator (Green)**
Lights when the power to the instrument is turned on.
- ② **Input display (Red)**
Indicates the input value during Run mode. Indicates characters of setting (or adjustment) item during Setup and Adjustment mode.
- ③ **Output display (Green)**
Indicates the output volume (%) during Run mode. Indicates set (or adjusted) value during Setup and Adjustment mode.
- ④ **Up key (▲)**
Increases the numeric value, or switches the selection items.
- ⑤ **Down key (▼)**
Decreases the numeric value, or switches the selection items.
- ⑥ **Mode key (○)**
Switches the setting mode and registers the set (or selected) value. By holding down this key for approx. 3 seconds, the unit proceeds to the Adjustment mode.
- ⑦ **Sub-mode key (Unmarked)**
If the Mode key is pressed while holding down this key, the unit proceeds to the Setup mode.

3. Mounting

3.1 External dimensions (Scale: mm)

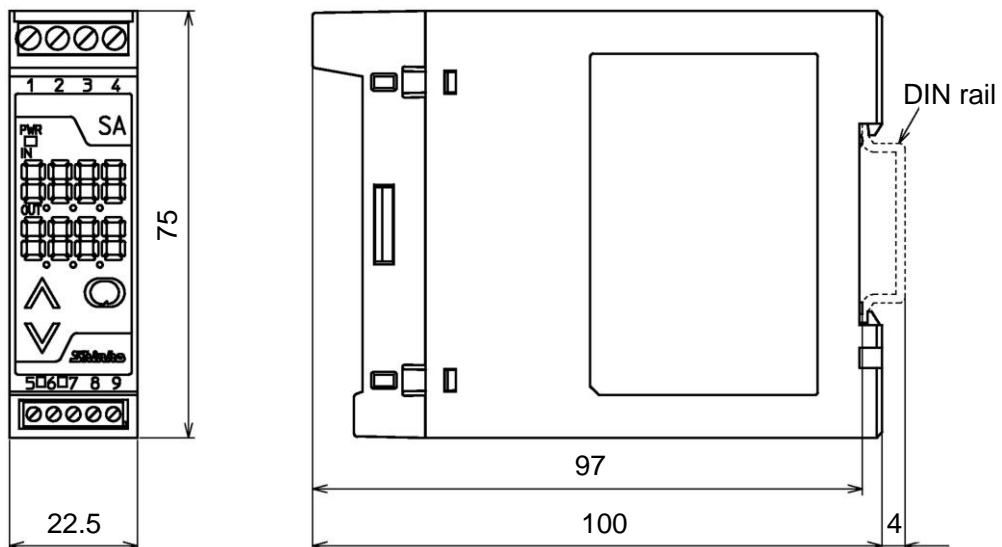

(Fig. 3.1-1)

Caution

- Mount the DIN rail horizontally.
- To remove this instrument, a flat blade screwdriver is required for pulling down the lever.
Never turn the screwdriver when inserting it into the release lever.
If excessive power is applied to the lever, it may break.
- Be sure to use commercially available fastening plates at both ends of the unit if it is in a position susceptible to vibration or shock.

Recommended fastening plate

Manufacturer	Model
Omron Corporation	End plate PFP-M
IDEC Corporation	Fastening plate BNL6
Panasonic Electric Works Co., Ltd.	Fastening plate ATA4806

Mounting to the DIN rail (Fig. 3.2-1)

First, hook ① of the instrument on the upper side of the DIN rail.

Second, making ① part of the instrument as a support, fit the lower part ② of the instrument to the DIN rail.

The unit will be completely fixed to the DIN rail when a “Click” sound is heard.

Removal from the DIN rail (Fig.3.2-2)

First, insert a flat blade screwdriver into the release lever (①).

Second, remove the instrument from the DIN rail by pulling down the lever (②).

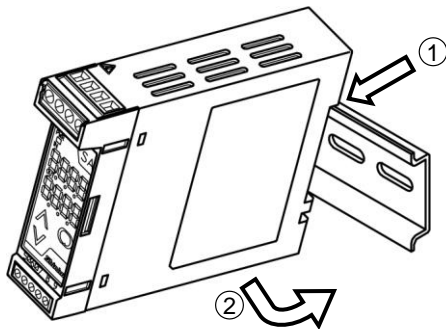

(Fig. 3.2-1) Mounting

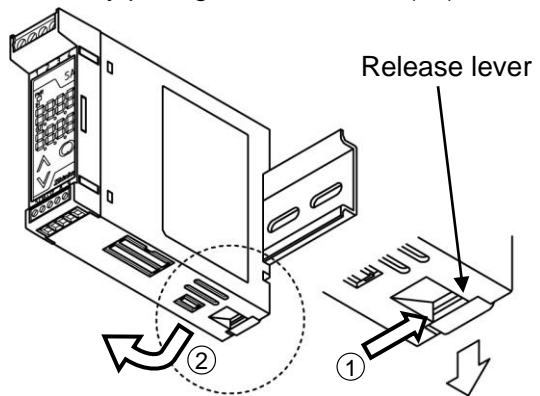

(Fig. 3.2-2) Removal

4. Wiring

Warning

Turn the power supply to the instrument off before wiring.

Working or touching the terminal with the power switched on may result in severe injury or death due to Electric Shock.

4.1 Recommended ferrules

When using ferrules, use the following recommended ferrules and crimping pliers made by Phoenix Contact GMBH &CO. See (Table 4.1-1) on page 8.

Take note that screw size and tightening torque differ depending on the terminal number.

(Table 4.1-1)

Terminal number	Terminal screw	Ferrules with insulation sleeve	Conductor cross sections	Tightening torque	Crimping pliers
1 to 4	M2.6	Al 0.25-8 YE	0.2 to 0.25mm ²	0.5 to 0.6N•m	CRIMPFOX ZA 3 CRIMPFOX UD 6
		Al 0.34-8 TQ	0.25 to 0.34mm ²		
		Al 0.5-8 WH	0.34 to 0.5mm ²		
		Al 0.75-8 GY	0.5 to 0.75mm ²		
		Al 1.0-8 RD	0.75 to 1.0mm ²		
5 to 9	M2.0	Al 0.25-8 YE	0.2 to 0.25mm ²	0.22 to 0.25N•m	
		Al 0.34-8 TQ	0.25 to 0.34mm ²		
		Al 0.5-8 WH	0.34 to 0.5mm ²		

4.2 Terminal arrangement and circuit configuration

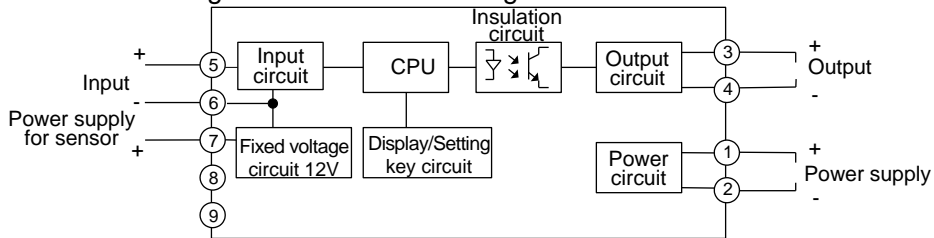

Input connection example

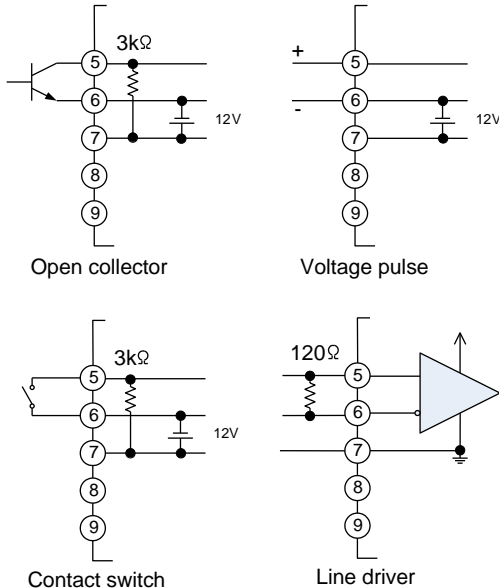

(Fig. 4.2-1)

4.3 Wiring of terminals [For SAFU-1□□ (Ultra low frequency transmitter)]

⚠ Warning

- For 100 to 240V AC, if an AC power source is connected to incorrect terminals, this instrument will burn out.
- For a 24V DC power source, do not confuse polarity when wiring.

4.3.1 Power source wiring

Use terminals ①(+) and ②(-) for the power supply to the instrument.

4.3.2 Output wiring

Use terminals ③(+) and ④(-) for the output wiring.

4.3.3 Input wiring

Terminals for wiring differs depending on the input specifications. Refer to (Fig. 4.2-1).

5. Operation flowchart

Power ON

Warm-up indication (Approx. 2sec.)

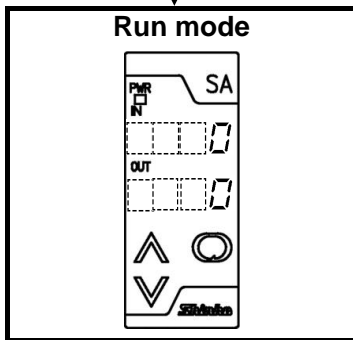

- To return from Adjustment to Run mode, press the key for approx. 3sec. From any setting item in Adjustment mode, it is possible to return to Run mode.

Hold down the for approx. 3sec.

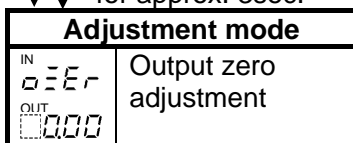

Press the key.

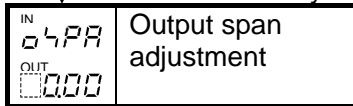

Press the key.

Press the key while holding down the Sub-mode key.

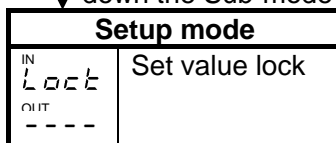

Press the key.

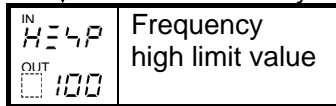

Press the key.

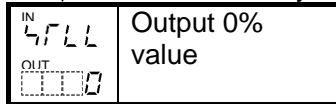

Press the key.

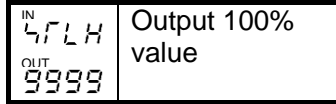

Press the key.

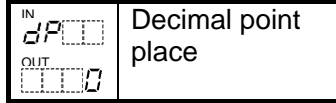

Press the key.

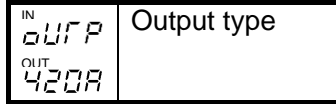

Press the key.

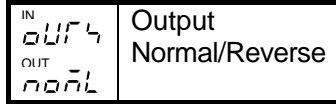

Press the key.

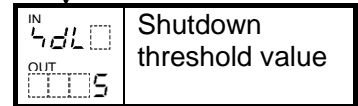

Press the key.

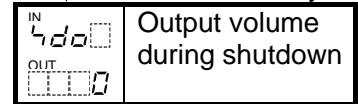

Press the key.



Press the key.

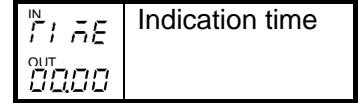

Press the key.

6. Setup

Setup should occur before using this unit, to set the Frequency high limit value, Output 0% value, Output 100% value, Output type etc. according to the users' specifications.

If the users' specifications are the same as the default value of the instrument, or if setup has already been completed, it is not necessary to set up the instrument. Proceed to Section "7. Adjustment".

(Table 6-1)

Setting item	Default value
Set value lock	Unlock
Frequency high limit value	SAFU-1□-□ (Ultra low frequency transmitter): 9999mHz SAFU-2□-□ (Low frequency transmitter, 100Hz max.): 100Hz SAFU-3□-□ (Low frequency transmitter, 50Hz min.): 9999Hz SAFU-4□-□ (Frequency transmitter): 100kHz
Output 0% value	0
Output 100% value	9999
Decimal point place	No decimal point
Output type	4 to 20mA DC
Output Normal/Reverse	Normal
Shutdown threshold value	5%
Output volume during shutdown	0%
Display selection	Input/Output indication
Indication time	00.00 (Continuous)

6.1 Indication after power-on

After power-on, warm-up status below (Fig. 6.1-1) is indicated for approx. 2sec.

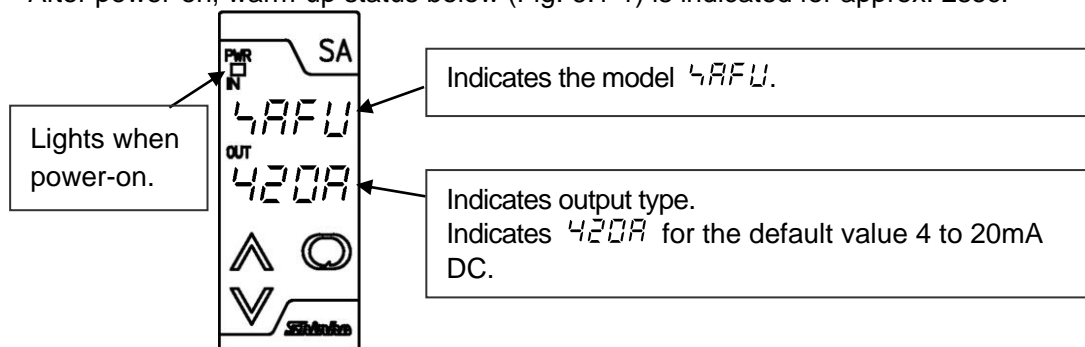

(Fig. 6.1-1)

After that, the unit switches to the Run mode as shown below (Fig. 6.1-2).

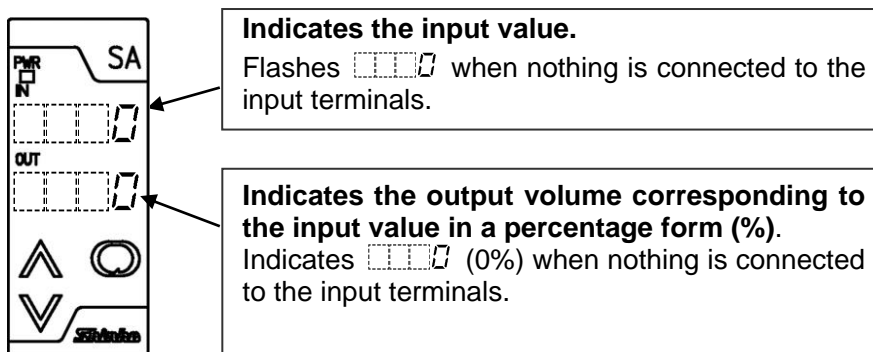

(Fig. 6.1-2)

6.2 Basic setup operation

Setup is conducted in the Setup mode.

To enter the Setup mode, press the  key while holding down the Sub-mode key in the Run mode. (Fig. 6.2-1)

To set (select) each item, use the  or  key, and register the value with the  key. (Fig. 6.2-2)

(1) Run mode

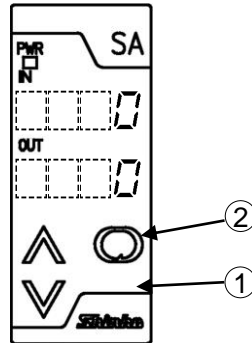

(Fig. 6.2-1)

To enter the Setup mode, press the  key **②** while holding down the Sub-mode key **①** in the Run mode.

(2) Setup mode

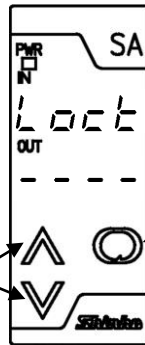

(Fig. 6.2-2)

To set (or select) each item, use these keys.

To proceed to each setting item and to register the set (selected) value, use this key.

6.3 Setup of the unit

The following shows all setup items. Set up the unit referring to the explanation of each item.

Display	Name, Function, Setting range	Default value
IN L o c k OUT - - - -	Set value lock Locks the set values to prevent setting errors. - - - - : Unlock L o c k : Lock (None of the set values and adjusted values can be changed.)	Unlock
IN H E L P OUT 100	Frequency high limit value Sets input frequency high limit value. (Frequency low limit value is fixed.) SAFU-1□-□ (Ultra low frequency transmitter) : 10 to 9999mHz SAFU-2□-□ (Low frequency transmitter, 100Hz max.): 1 to 100Hz SAFU-3□-□ (Low frequency transmitter, 50Hz min.) : 50 to 9999Hz SAFU-4□-□ (Frequency transmitter) : 1 to 100kHz	SAFU-1□-□: 9999mHz SAFU-2□-□(100Hz max): 100Hz SAFU-3□-□(50Hz min): 9999Hz SAFU-4□-□: 100kHz

Display	Name, Function, Setting range	Default value
4FLL OUT 0000	Output 0% value	0
	Sets the value (indicated on the Input display) at 0% output. Setting range: -1999 to Output 100% value	
IN 4FLH OUT 9999	Output 100% value	9999
	Sets the value (indicated on the Input display) at 100% output. Setting range: Output 0% value to 9999	
IN dP00 OUT 0000	Decimal point place	No decimal point
	Selects the decimal point place. 0000: No decimal point 0000: 1 digit after decimal point 0000: 2 digits after decimal point 0000: 3 digits after decimal point	
IN oWFP OUT 420A	Output type	4 to 20mA DC
	Selects the output type. 420A: 4 to 20mA DC 020A: 0 to 20mA DC 012A: 0 to 12mA DC 010A: 0 to 10mA DC 05A: 1 to 5mA DC 01V: 0 to 1V DC 05V: 0 to 5V DC 05V: 1 to 5V DC 010V: 0 to 10V DC	
IN oWF4 OUT noFL	Output Normal/Reverse	Normal
	Selects either Normal mode (0.0 to 100.0%) or Reverse mode (100.0 to 0.0%) for output status. (Fig. 6.3-1) noFL: Normal rEB4: Reverse	
IN 4dL0 OUT 0005	Shutdown threshold value	5%
	Sets the threshold value to determine shutdown. Setting range: 0 to 10% of frequency span	
IN 4da0 OUT 0000	Output volume during shutdown	0%
	Sets output volume when shutting down. Setting range: -5 to 105%	
IN dI 4P OUT dUAL	Display selection	Input/Output indication
	Selects an indication type on the display. dUAL: Input/Output indication I n00: Input indication oWF0: Output indication nonE: No indication (Only the power indicator is lit.)	

Display	Name, Function, Setting range	Default value
IN 71.7E OUT 00.00	Indication time Sets the indication time of the display after the final key operation. Not available if No indication (Only the power indicator is lit) is selected during Display selection After the indication time has elapsed, the displays go off (Only the power indicator is lit.). If power is turned on again, or if any of the Δ , ∇ , \odot or Sub-mode keys are pressed while displays are unlit, the displays will light again. Setting range: 00.00: Continuous 00.01 (1 second) to 60.00 (60 minutes) [Minutes.Seconds]	00.00 (Continuous)

6.3.1 When using this unit as a standard frequency transmitter

Set the Output Normal/Reverse selection to "Normal". (Fig. 6.3-1)

6.3.2 When using the Reverse function

This function reverses the output (100 to 0%) that corresponds to the input (0 to 100%).

Set the Output Normal/Reverse selection to "Reverse". (Fig. 6.3-1)

- For SAFU-1□-□ (Ultra low frequency transmitter),
SAFU-2□-□ [Low frequency transmitter (100Hz max)]

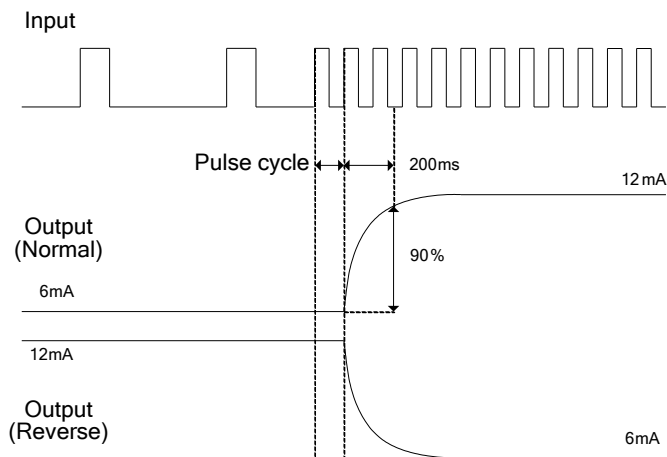

- For SAFU-3□-□ (Low frequency transmitter, 50Hz min),
SAFU-4□-□ (Frequency transmitter)

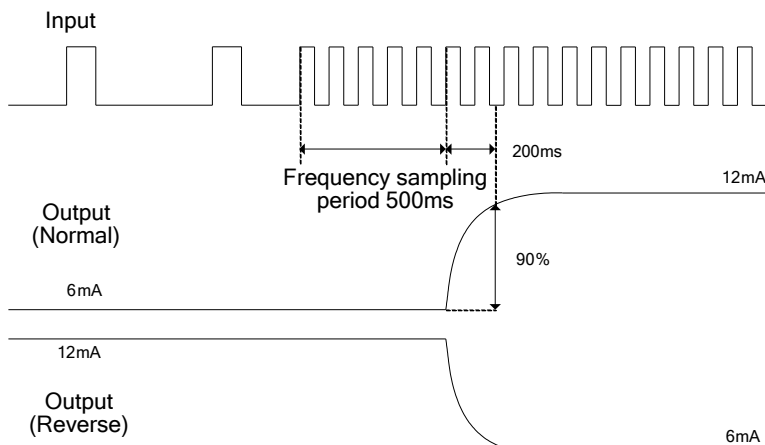

(Fig. 6.3-1)

7. Adjustment

Performs the output zero and span adjustments.



Connect a pulse generator to the input terminals of this instrument.

Connect a digital multimeter to output terminals.

7.1 Basic operation of adjustment

Perform adjustment in the Adjustment mode.

To enter Adjustment mode, hold down the  key for approx. 3 seconds in the Run mode. (Fig. 7.1-1)

For output adjustment, use the  or  key, and register the value with the  key. (Fig. 7.1-2)

To revert to the Run mode, press the  key again for approximately 3 seconds.

(1) Run mode

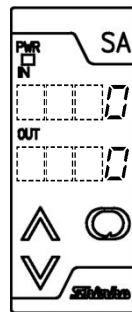

To enter Adjustment mode, please hold down the  key for approx. 3 seconds.

(Fig. 7.1-1)

(2) Adjustment mode

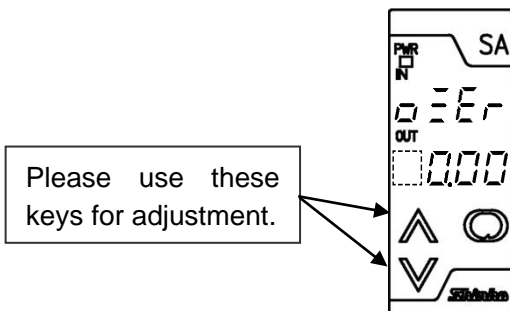

Please use these keys for adjustment.



To proceed to each adjustment item in the Adjustment mode and to register the adjusted value, please use this key.

(Fig. 7.1-2)

7.2 Adjustment

The following shows all adjustment items.

Adjust values referring to the explanation of each item below.

Display	Name, Function, Setting range	Default value
	Output zero adjustment Adjusts output zero. Input the value corresponding to 0% output, then adjust the value with the \blacktriangle or \blacktriangledown key while viewing the output value (on the digital multimeter). When the output range lower limit is zero, (even if zero adjustment results in a negative value), the output value will not be negative. Setting range: -5.00 to 5.00% Effective range of adjustment differs depending on the output types. 4 to 20mA DC: -5 to 5% 0 to 20mA DC: 0 to 5% 0 to 12mA DC: 0 to 5% 0 to 10mA DC: 0 to 5% 1 to 5mA DC : -5 to 5% 0 to 1V DC : 0 to 5% 0 to 5V DC : 0 to 5% 1 to 5V DC : -5 to 5% 0 to 10V DC : 0 to 5%	0.00%
	Output span adjustment Adjusts output span. Input the value corresponding to 100% output, then adjust the value with the \blacktriangle or \blacktriangledown key while viewing the output value (on the digital multimeter). Setting range: -5.00 to 5.00% Effective range of adjustment: 95 to 105%	0.00%

8. Unit operation

8.1 Indication after power-on

After power-on, the following warm-up status is indicated for 2 seconds (Fig. 8.1-1).

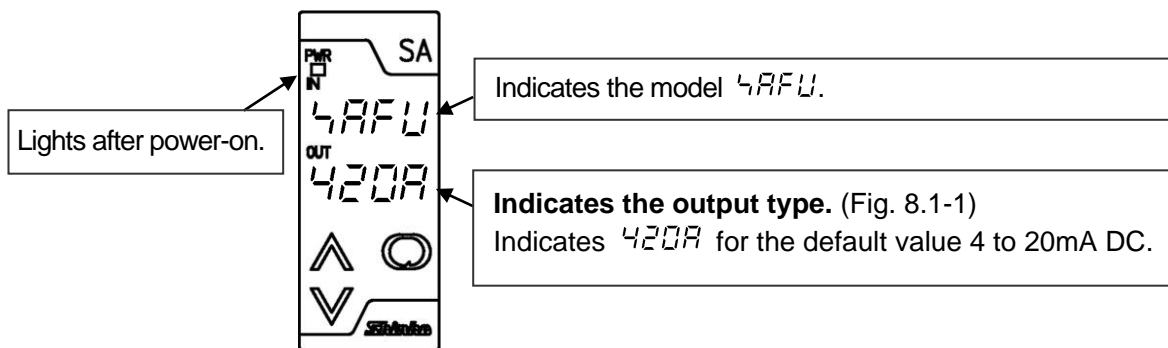

(Fig. 8.1-1)

(Table 8.1-1)

Output	Output display	Output	Output display
4 to 20mA DC	420A	0 to 1V DC	0.1V
0 to 20mA DC	020A	0 to 5V DC	0.5V
0 to 12mA DC	012A	1 to 5V DC	1.5V
0 to 10mA DC	010A	0 to 10V DC	0.10V
1 to 5mA DC	1.5A		

8.2 Unit operation

The unit enters the Run mode after approx. 2-second warm-up as shown in (Fig. 8.2-1). The input selected during Input selection is converted to the output selected during Output type selection.

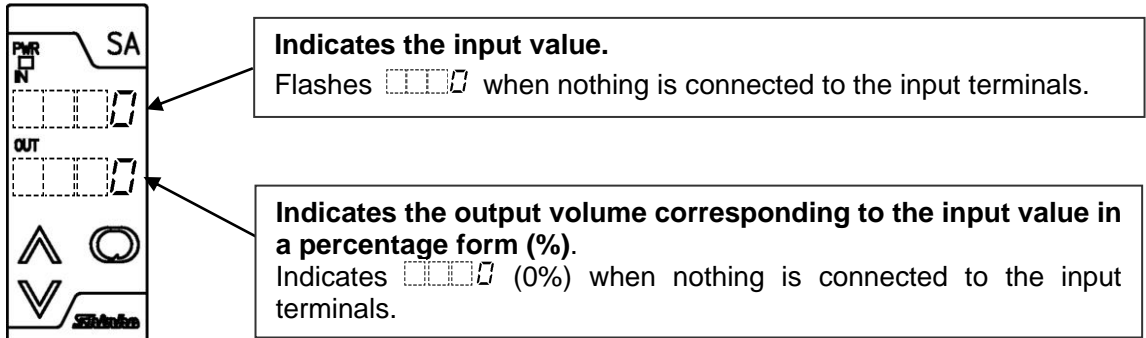

(Fig. 8.2-1)

- **Indication when input value is 10000 or more**

For the indication of 10000 or more, the lower 4 digits of input value are flashing.

(e.g.) Indication of 10020

IN
0020 ← Flashes.

- **Indication when pulse is absent or when shutting down**

When pulse is absent, 0 (zero) flashes.

When input frequency is lower than shutdown threshold value, the input value flashes.

- **Overrange indication**

In case of overrange (1.1 times frequency high limit value), "----" flashes on the Input display.

- **Indication time setting**

If indication time is set, the displays will go off after the indication time has elapsed.

(Only the power indicator is lit.)

If power is turned on again, or if any of the ▲, ▼, ○ or Sub-mode keys are pressed while displays are unlit, the displays will light again.

9. Specifications

Input specifications

Frequency measurement via input signals

Open collector

Frequency range : SAFU-1□-□ (Ultra low frequency transmitter)

0.001 to 9.999Hz (Minimum range: 0.001 to 0.01Hz)

SAFU-2□-□ (Low frequency transmitter, 100Hz Max.)

0.001 to 100Hz (Minimum range: 0.001 to 1Hz)

SAFU-3□-□ (Low frequency transmitter, 50Hz Min.)

0.001 to 9999Hz (Minimum range: 0.001 to 50Hz)

SAFU-4□-□ (Frequency transmitter)

0.001Hz to 100kHz (Minimum range: 0.001Hz to 1kHz)

Minimum pulse width: 4μs or more (for ON and OFF)

Input detection voltage/current: ON: Max. 30mA (30V or less)

OFF: Residual voltage, 0.5V or less

Action input conditions: ON: 200Ω or less

OFF: 100kΩ or more

Voltage pulse

Frequency range	: SAFU-1□-□ (Ultra low frequency transmitter) 0.001 to 9.999Hz (Minimum range: 0.001 to 0.01Hz)
	SAFU-2□-□ (Low frequency transmitter, 100Hz Max.) 0.001 to 100Hz (Minimum range: 0.001 to 1Hz)
	SAFU-3□-□ (Low frequency transmitter, 50Hz Min.) 0.001 to 9999Hz (Minimum range: 0.001 to 50Hz)
	SAFU-4□-□ (Frequency transmitter) 0.001Hz to 100kHz (Minimum range: 0.001Hz to 1kHz)
Minimum pulse width:	4 μ s or more (for High and Low)
Waveform	: Rectangular, sine waveform or similar
Detection level	: Low: 1V DC or less High: 2V DC or more
Input impedance	: 100k Ω or more
Input amplitude	: 2 to 50V _{p-p}

Line driver

AM26LS31 or equivalent	
Receiver	: AM26LS32 or equivalent
Terminator	: 120 Ω

Contact switch for only SAFU-1□-□ (Ultra low frequency transmitter)

Frequency range	: 0.001 to 5Hz
Minimum pulse width:	10ms or more (for ON and OFF)
Action input conditions:	ON: 200 Ω or less OFF: 100k Ω or more

Output specifications

DC current

Output	Allowable load resistance	Zero adjustment range	Span adjustment range
4 to 20mA DC	700 Ω or less	-5 to 5%	95 to 105%
0 to 20mA DC	700 Ω or less	0 to 5%	95 to 105%
0 to 12mA DC	1.2k Ω or less	0 to 5%	95 to 105%
0 to 10mA DC	1.2k Ω or less	0 to 5%	95 to 105%
1 to 5mA DC	2.4k Ω or less	-5 to 5%	95 to 105%

DC voltage

Output	Allowable load resistance	Zero adjustment range	Span adjustment range
0 to 1V DC	100 Ω or more	0 to 5%	95 to 105%
0 to 5V DC	500 Ω or more	0 to 5%	95 to 105%
1 to 5V DC	500 Ω or more	-5 to 5%	95 to 105%
0 to 10V DC	1k Ω or more	0 to 5%	95 to 105%

When the output range lower limit is zero, (even if zero adjustment results in a negative value), the output value will not be negative.

Performance

Reference accuracy	: Within $\pm 0.1\%$ (At 23 $^{\circ}$ C of ambient temperature)
Output accuracy	: Within $\pm 0.1\%$
Display accuracy	: Within Reference accuracy ± 1 digit
Frequency sampling period:	500ms (SAFU-3□-□, SAFU-4□-□)

Response time : 200ms+Pulse cycle for
 SAFU-1□-□ (Ultra low frequency transmitter) and
 SAFU-2□-□ (Low frequency transmitter, 100Hz Max.)
 : 700ms+Frequency sampling period or less for
 SAFU-3□-□ (Low frequency transmitter, 50Hz Min.) and
 SAFU-4□-□ (Frequency transmitter)

Temperature coefficient : ±0.015%/°C

Insulation resistance : Input – Output – Power: 10MΩ or more, at 500V DC

Dielectric strength : Input – Output – Power: 2.0kV AC for 1 minute

General structure

Case : Flame-resistant resin, Color: Light gray

Front panel : Membrane sheet

Setting : By the front keypad

Displays, indicator : Input display : 7 segments Red LED display 4 digits
 Character size: 7.4 x 4.0mm (H x W)
 Output display : 7 segments Green LED display 4 digits
 Character size: 7.4 x 4.0mm (H x W)
 Power indicator: Green LED

Installation specifications

Power supply : 100 to 240V AC 50/60Hz, 24V AC/DC 50/60Hz

Allowable voltage range : 85 to 264V AC, 20 to 28V AC/DC

Power consumption : Approx. 9VA

Power supply for sensor : 12V DC±5%, 25mA

Ambient temperature : -5 to 55°C (23 to 131°F)

Ambient humidity : 35 to 85%RH (Non-condensing)

Altitude : 2,000 m or less

Weight : Approx. 120g

Mounting : DIN rail mounting

External dimensions : W22.5 x H75 x D100mm

Attached functions

- Power failure countermeasure: The setting data is backed up in the non-volatile IC memory.
- Self-diagnosis:
 The CPU is monitored by a watchdog timer, and when an abnormal status is found on the CPU, the unit is switched to warm-up status after turning all outputs off.
- Detecting unconnected sensor:
 If pulse is not detected for a constant period, the unit will revert to the initial status (0Hz).
 SAFU-1□-□ (Ultra low frequency transmitter) : 1000sec
 SAFU-2□-□ (Low frequency transmitter, 100Hz Max.): 100sec
 SAFU-3□-□ (Low frequency transmitter, 50Hz Min.) : 1sec
 SAFU-4□-□ (Frequency transmitter) : 1sec

10. Troubleshooting

10.1 Indication

Problem	Presumed cause and solution
The input display is flashing "----".	<ul style="list-style-type: none"> • Check whether the input exceeds 1.1 times frequency high limit value. Confirm the input signal source. • Check whether the sensor is securely connected to the input terminals of this instrument. Connect the sensor terminals to the input terminals of this unit. • Check whether the signal source is correct. Check the input signal source.
Input value 0 (zero) is flashing.	<ul style="list-style-type: none"> • Check if pulse is absent. Confirm the input signal source.
Input value is flashing.	<ul style="list-style-type: none"> • Check if the input value is lower than the shutdown threshold value. Confirm the input signal source.

The indication of the Input display is irregular or unstable.	<ul style="list-style-type: none"> • AC leaks into the sensor circuit. Use an ungrounded type sensor. • There may be equipment that interferes with or makes noise near the unit. Keep equipment that interferes with or makes noise away from the unit.
---	--

10.2 Key operation

Problem	Presumed cause and solution
Setting or adjustment is not possible.	<ul style="list-style-type: none"> • “Lock” is selected during Set value lock selection. Select “Unlock”.

10.3 Running

Problem	Presumed cause and solution
Input value does not change.	<ul style="list-style-type: none"> • The sensor may be out of order. Change the sensor. • Check whether input and output wires are securely connected to the I/O terminals of the instrument. Ensure that input and output wires are securely connected to the I/O terminals. • Check whether the wiring of input and output is correct.
No output	<ul style="list-style-type: none"> • Check whether Output 100% and Output 0% value have been set to suitable values. • Check whether Output and Output Normal/Reverse have been selected correctly during Output selection and Output Normal/Reverse selection.

11. Character table

Refer to the following default values.

Setup mode

Display	Setting item	Default value	Data
LoCk	Set value lock	Unlock	
H _z 4P	Frequency high limit value	SAFU-1□-□(Ultra low frequency transmitter): 9999mHz SAFU-2□-□(Low frequency transmitter, 100Hz Max.): 100Hz SAFU-3□-□(Low frequency transmitter, 50Hz Min): 9999Hz SAFU-4□-□(Frequency transmitter): 100kHz	
4FL	Output 0% value	0	
4FH	Output 100% value	9999	
dP□□	Decimal point place	No decimal point	
oUFP	Output type	4 to 20mA DC	
oUF4	Output Normal/Reverse	Normal	
4dL□	Shutdown threshold value	5%	
4do□	Output volume during shutdown	0%	
dI 4P	Display selection	Input/Output indication	
TI nE	Indication time	00.00 (Continuous)	

Adjustment mode

Display	Setting item	Default value	Data
oZE r	Output zero adjustment	0.00%	
o4PR	Output span adjustment	0.00%	

***** Inquiries *****

For any inquiry about this unit, please contact the vendor where you purchased the unit or our agency after checking the following.
(e.g.)

- Model SAFU-□□-□
- Serial number No. xxxxxx

In addition to the above, please let us know the details of malfunction, if any, and the operating conditions.

SHINKO TECHNOS CO., LTD.
OVERSEAS DIVISION

Head Office: 2-5-1, Senbahigashi, Minoo, Osaka, 562-0035, Japan

[URL] <https://shinko-technos.co.jp/e/>

Tel: +81-72-727-6100

[E-mail] overseas@shinko-technos.co.jp

Fax: +81-72-727-7006