

DIGITAL INDICATING CONTROLLER

ACS-13A

INSTRUCTION MANUAL

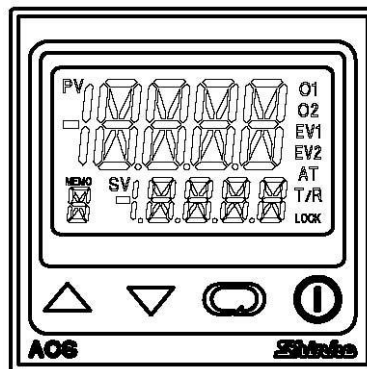

Shinko

Preface

Thank you for purchasing our digital indicating controller ACS-13A. This manual contains instructions for the mounting, functions, operations and notes when operating the ACS-13A. To prevent accidents arising from the misuse of this controller, please ensure the operator receives this manual.

Characters used in this manual:

Indication	1	0	1	2	3	4	5	6	7	8	9	℃	℉
Number, °C/°F	-1	0	1	2	3	4	5	6	7	8	9	℃	℉
Indication	A	b	c	d	E	F	G	H	I	J	K	L	M
Alphabet	A	B	C	D	E	F	G	H	I	J	K	L	M
Indication	N	o	P	Q	R	S	T	U	V	W	X	Y	Z
Alphabet	N	O	P	Q	R	S	T	U	V	W	X	Y	Z

Notes

- This instrument should be used in accordance with the specifications described in the manual. If it is not used according to the specifications, it may malfunction or cause a fire.
- Be sure to follow the warnings, cautions and notices. If they are not observed, serious injury or malfunction may occur.
- The contents of this instruction manual are subject to change without notice.
- Care has been taken to ensure that the contents of this instruction manual are correct, but if there are any doubts, mistakes or questions, please inform our sales department.
- This instrument is designed to be installed through a control panel indoors. If it is not, measures must be taken to ensure that the operator cannot touch power terminals or other high voltage sections.
- Any unauthorized transfer or copying of this document, in part or in whole, is prohibited.
- Shinko Technos Co., Ltd. is not liable for any damage or secondary damage(s) incurred as a result of using this product, including any indirect damage.

Safety Precautions (Be sure to read these precautions before using our products.)

The safety precautions are classified into categories: "Warning" and "Caution". Depending on circumstances, procedures indicated by  Caution may result in serious consequences, so be sure to follow the directions for usage.

Warning

Procedures which may lead to dangerous conditions and cause death or serious injury, if not carried out properly.

Caution

Procedures which may lead to dangerous conditions and cause superficial to medium injury or physical damage or may degrade or damage the product, if not carried out properly.

Warning

- To prevent an electrical shock or fire, only Shinko or other qualified service personnel may handle the inner assembly.
- To prevent an electrical shock, fire or damage to the instrument, parts replacement may only be undertaken by Shinko or other qualified service personnel.

Safety Precautions

- To ensure safe and correct use, thoroughly read and understand this manual before using this instrument.
- This instrument is intended to be used for industrial machinery, machine tools and measuring equipment. Verify correct usage after purpose-of-use consultation with our agency or main office. (Never use this instrument for medical purposes with which human lives are involved.)
- External protection devices such as protective equipment against excessive temperature rise, etc. must be installed, as malfunction of this product could result in serious damage to the system or injury to personnel. Proper periodic maintenance is also required.
- This instrument must be used under the conditions and environment described in this manual. Shinko Technos Co., Ltd. does not accept liability for any injury, loss of life or damage occurring due to the instrument being used under conditions not otherwise stated in this manual.

Warning on Model Label



Caution

Failure to handle this instrument properly may result in minor or moderate injury or property damage due to fire, malfunction, malfunction, or electric shock. Please read this manual before using the product to ensure that you fully understand the product.



Caution with Respect to Export Trade Control Ordinance

To avoid this instrument from being used as a component in, or as being utilized in the manufacture of weapons of mass destruction (i.e. military applications, military equipment, etc.), please investigate the end users and the final use of this instrument. In the case of resale, ensure that this instrument is not illegally exported.

1. Installation Precautions



Caution

This instrument is intended to be used under the following environmental conditions (IEC61010-1): Overvoltage category II, Pollution degree 2

Ensure the mounting location corresponds to the following conditions:

- A minimum of dust, and an absence of corrosive gases
- No flammable, explosive gases
- No mechanical vibrations or shocks
- No exposure to direct sunlight, an ambient temperature of 0 to 50°C (32 to 122°F) that does not change rapidly, and no icing
- An ambient non-condensing humidity of 35 to 85 %RH
- No large capacity electromagnetic switches or cables through which large current is flowing
- No water, oil or chemicals or where the vapors of these substances can come into direct contact with the unit
- Please note that the ambient temperature of this unit – not the ambient temperature of the control panel – must not exceed 50°C (122°F) if mounted through the face of a control panel. Otherwise the life of electronic components (especially electrolytic capacitors) may be shortened.

Note: Avoid setting this instrument directly on or near flammable material even though the case of this instrument is made of flame-resistant resin.

2. Wiring Precautions

Caution

- Do not leave wire remnants in the instrument, as they could cause a fire or malfunction.
- Use the solderless terminal with an insulation sleeve in which the M3 screw fits when wiring the ACS-13A.
- The terminal block of this instrument is designed to be wired from the left side. The lead wire must be inserted from the left side of the terminal, and fastened with the terminal screw.
- Tighten the terminal screw using the specified torque. If excessive force is applied to the screw when tightening, the terminal screw or case may be damaged.
- When using a terminal cover, pass terminal wires numbered 7 to 12 into the holes of the terminal cover.
- This instrument does not have a built-in power switch, circuit breaker and fuse.
It is necessary to install a power switch, circuit breaker and fuse near the controller.
(Recommended fuse: Time-lag fuse, rated voltage 250 V AC, rated current 2 A)
- For a 24 V AC/DC power source, do not confuse polarity when using direct current (DC).
- Do not apply a commercial power source to the sensor which is connected to the input terminal nor allow the power source to come into contact with the sensor.
- Use a thermocouple and compensating lead wire according to the sensor input specifications of this controller.
- Use the 3-wire RTD according to the sensor input specifications of this controller.
- (+) side input terminal number of 0 to 5 V DC, 1 to 5 V DC, 0 to 10 V DC differs from that of 0 to 1 V DC.
(+) side input terminal number of 0 to 5 V DC, 1 to 5 V DC, 0 to 10 V DC: 9
(+) side input terminal number of 0 to 1 V DC: 10
- When using a relay contact output type, externally use a relay according to the capacity of the load to protect the built-in relay contact.
- When wiring, keep input wires (thermocouple, RTD, etc.) away from AC sources or load wires.

3. Operation and Maintenance Precautions

Caution

- It is recommended that auto-tuning (AT) be performed on the trial run.
- Do not touch live terminals. This may cause electrical shock or problems in operation.
- Turn the power supply to the instrument OFF when retightening the terminal or cleaning.
Working on or touching the terminal with the power switched ON may result in severe injury or death due to electrical shock.
- Use a soft, dry cloth when cleaning the instrument.
(Alcohol based substances may tarnish or deface the unit.)
- As the display section is vulnerable, be careful not to put pressure on, scratch or strike it with a hard object.

4. Compliance with Safety Standards

Caution

- Always install the recommended fuse described in this manual externally.
- If the instrument is used in a manner not specified by the manufacturer, the protection provided by the instrument may be impaired.
- Use a device with reinforced insulation or double insulation for the external circuit connected to this product.
- When using this product as a UL certified product, use a power supply conforming to Class 2 or LIM for the external circuit connected to the product.

Abbreviations used in this manual

Symbol	Term	Symbol	Term
PV	Process variable	OUT1	Control output 1
SV	Desired value	OUT2	Control output 2
MV	Output manipulated variable	AT	Auto-tuning

Contents

	Page
1. Model.....	6
1.1 Model.....	6
1.2 How to Read the Model Label.....	6
2. Names and Functions of Controller.....	7
3. Mounting to the Control Panel.....	8
3.1 External Dimensions (Scale: mm).....	8
3.2 Panel Cutout (scale: mm).....	8
3.3 CT (Current Transformer) External Dimensions (scale: mm).....	8
3.4 Mounting to and Removal from the Control Panel.....	9
4. Wiring.....	10
4.1 Terminal Arrangement.....	10
4.2 Lead Wire Solderless Terminal.....	10
4.3 Terminal Cover.....	11
4.4 Heater Burnout Alarm Output (W, W3 Option) Wiring.....	11
5. Operation Flowchart.....	12
6. Setup.....	13
6.1 Turn the Power Supply to the ACS-13A ON.....	13
6.2 Basic Key Operations.....	13
6.3 Setup Mode.....	14
7. Settings.....	21
7.1 Main Setting Mode.....	21
7.2 Sub Setting Mode.....	22
7.3 Auxiliary Function Setting Mode.....	24
8. Operation.....	26
8.1 Starting Operation.....	26
8.2 Control Output OFF Function.....	27
8.3 Auto/Manual Control Switching.....	27
8.4 Indicating the Output MV.....	28
8.5 AT/Auto-reset Perform, AT Cancel.....	28
9. Auto-reset.....	29
10. AT (Auto-tuning).....	30
11. Action Explanation.....	31
11.1 OUT1 Action.....	31
11.2 OUT1 ON/OFF Control Action.....	31
11.3 Heater Burnout Alarm Action.....	32
11.4 Alarm Action.....	32
11.5 OUT2 (Heating/Cooling Control) Action.....	33
11.6 OUT2 (Heating/Cooling Control) Action (When Setting Dead Band).....	34
11.7 OUT2 (Heating/Cooling Control) Action (When Setting Overlap Band).....	35
12. Specifications.....	36
12.1 Standard Specifications.....	36
12.2 Optional Specifications.....	39
13. Troubleshooting.....	41
13.1 Indication.....	41
13.2 Key Operation.....	42
13.3 Control.....	42
14. Character Table.....	43

1. Model

1.1 Model

ACS - 1 3 □-□/□ □, □ □ □				Series name: ACS-13A (W48 x H48 x D62mm)	
Control action	3				PID
A1	A				Alarm type can be selected by keypad. *1
Control output OUT1	R				Relay contact: 1a
	S				Non-contact voltage (for SSR drive): 12 V DC±15%
	A				Direct current: 4 to 20 mA DC *6
Input		M			Multi-range *2
Power supply voltage					100 to 240 V AC (standard)
		1			24 V AC/DC *3
Option	A2				Alarm 2 output (A2) *1, *4: *5: *8
	W(20A)	Heater			CT rated current: 20 A (Single phase)
	W(50A)	burnout			CT rated current: 50 A (Single phase)
	W3(20A)	alarm			CT rated current: 20 A (3-phase)
	W3(50A)	*5 *6 *7:*8			CT rated current: 50 A (3-phase)
	DR	Control output OUT2			Relay contact: 1a
	DS	*4: *7: *8			Non-contact voltage: 12 V DC±15%
	C5	Serial communication (RS-485) *9			
	SM	Set value memory external selection *9			

*1 Alarm types (9 types and No alarm action) and Energized/De-energized can be selected by keypad.

*2 Thermocouple, RTD, DC voltage and current can be selected by keypad.

*3 Power supply voltage 100 to 240 V AC is standard.

When ordering 24 V AC/DC, enter '1' in Power supply voltage, after 'M'.

*4 If A2 option is ordered, D□ option cannot be ordered.

*5 A2 and W, W3 option utilize common output terminals.

*6 W, W3 option cannot be ordered to Direct current output type.

*7 If W, W3 option is ordered, D□ option cannot be ordered.

*8 If D□ option is ordered, A2 and W,W3 option cannot be ordered.

*9 C5 and SM option cannot be ordered together,

1.2 How to Read the Model Label



(1) The model label is attached to the left side of the case.
For Heater burnout alarm output, CT rated current is written in the bracket.

(2) (1) Model, Power supply (For 24 V AC/DC, "1" is entered), Options
(2) Serial number

(e.g.) Relay contact output / Multi-range input

(Fig.1.2-1)

2. Names and Functions of Controller

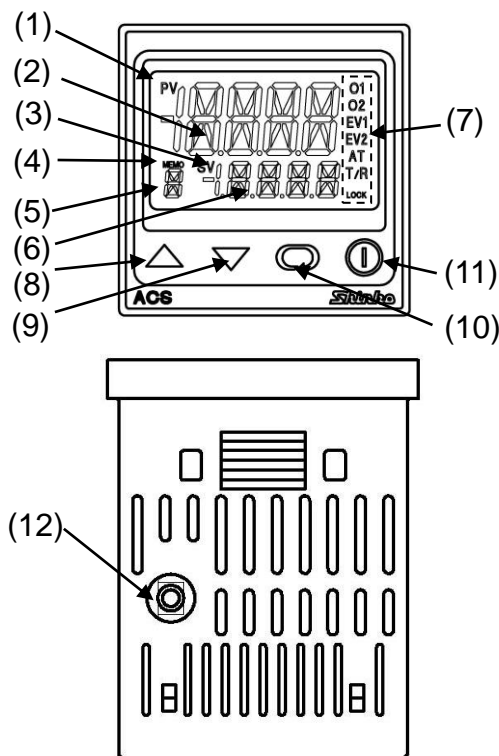

(Fig. 2-1)

Display

- (1) **PV indicator:** Lights when PV is indicated in PV/SV Display Mode.
- (2) **PV Display:** Indicates the PV (process variable) or setting characters in each setting mode.
- (3) **SV indicator:** Lights when SV is indicated in PV/SV Display Mode.
- (4) **MEMO indicator:** Lights when Set value memory external selection (SM option) is ordered.
- (5) **MEMO Display:** Indicates the set value memory number.
- (6) **SV Display:** Indicates the SV (desired value), MV or set values in each setting mode.
- (7) **Action indicators**
- O1 (OUT1):** Lights when control output OUT1 is ON.
For Direct current output type, flashes corresponding to the MV in 250 ms cycles.
 - O2 (OUT2):** Lights when control output OUT2 (D□ option) is ON.
 - EV1:** Lights when Alarm 1 output is ON.
 - EV2:** Lights when Alarm 2 output (A2 option) is ON or when Heater burnout alarm (W, W3 option) is ON.
 - AT:** Flashes while AT (auto-tuning) or auto-reset is performing.
 - T/R:** Lights during Serial communication (C5 option) TX (transmitting) output.
 - LOCK:** Lights when Lock 1, Lock 2 or Lock 3 is selected.

Key Operations

- (8) **△ UP key:** Increases the numerical value.
- (9) **▽ DOWN key:** Decreases the numerical value.
- (10) **⊞ MODE key:** Selects the setting mode, or registers the set value.
To register the set (selected) value, press this key.
- (11) **Ⓜ OUT/OFF key:** Switches the control output ON/OFF or Auto/Manual control.
To cancel the Control output OFF function, press this key for approx. 1 second.
- (12) **Console connector:**

By connecting to the USB communication cable (CMA, sold separately), the following operations can be conducted from an external computer using the Console software SWS-ACS01M.

- Reading and setting of SV, PID and various set values
- Reading of PV and action status
- Function change

3. Mounting to the Control Panel

3.1 External Dimensions (Scale: mm)

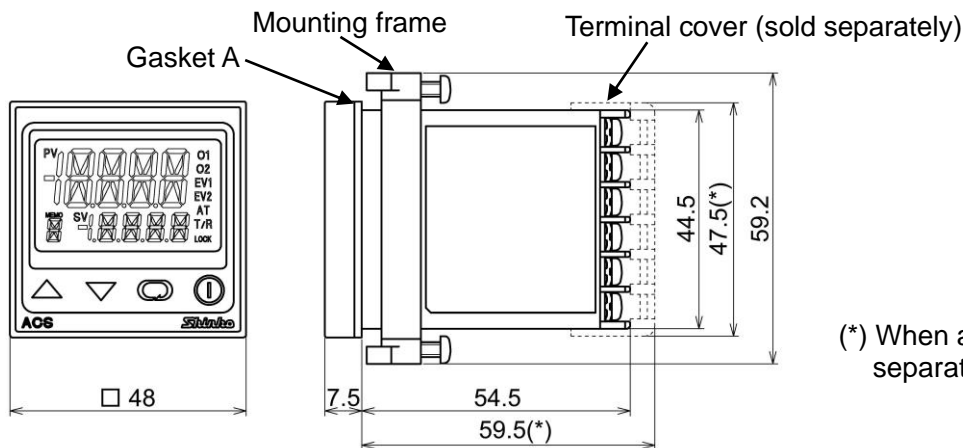

(*) When a terminal cover (sold separately) is used.

(Fig. 3.1-1)

3.2 Panel Cutout (scale: mm)

⚠ Caution

If horizontal close mounting is used for the controller, IP66 specification (Drip-proof/Dust-proof) may be compromised, and all warranties will be invalidated.

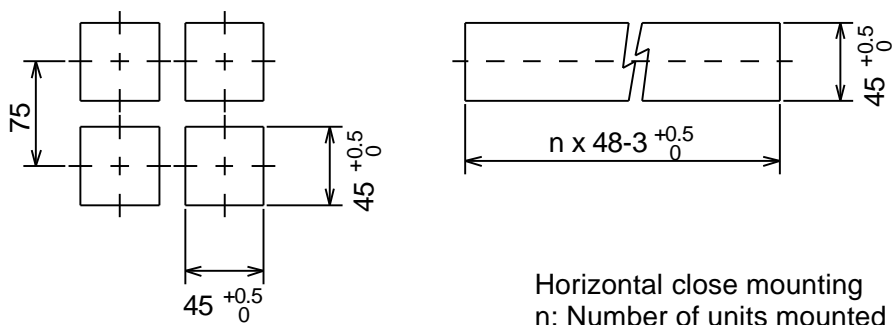

Horizontal close mounting
n: Number of units mounted

(Fig. 3.2-1)

3.3 CT (Current Transformer) External Dimensions (scale: mm)

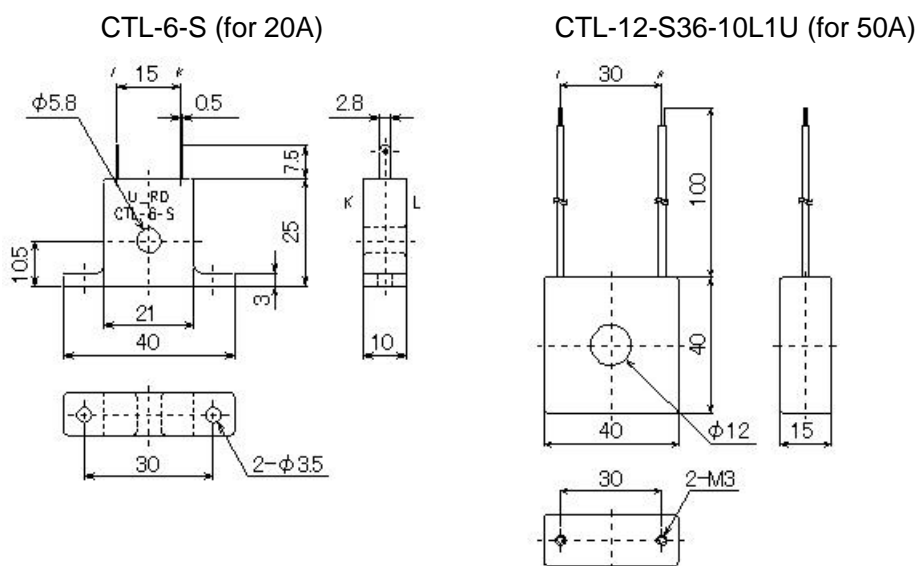

(Fig. 3.3-1)

3.4 Mounting to and Removal from the Control Panel



Caution

As the mounting frame is made of resin, do not use excessive force while tightening screws, or the mounting frame could be damaged.

Tighten screws with one rotation upon the screw tips touching the panel.

The torque is 0.05 to 0.06 N•m.

How to mount the ACS-13A

Mount the controller vertically to the flat, rigid panel to ensure it adheres to the Drip-proof/Dust-proof specification (IP66).

Mountable panel thickness: 1 to 5 mm

(1) Insert the controller from the front side of the panel. (Fig.3.4-1)

(2) Insert the mounting frame until it comes into contact with the panel, and fasten with the screw.

Tighten screws with one rotation upon the screw tips touching the panel. (Fig.3.4-2)

The torque is approximately 0.05 to 0.06 N•m.

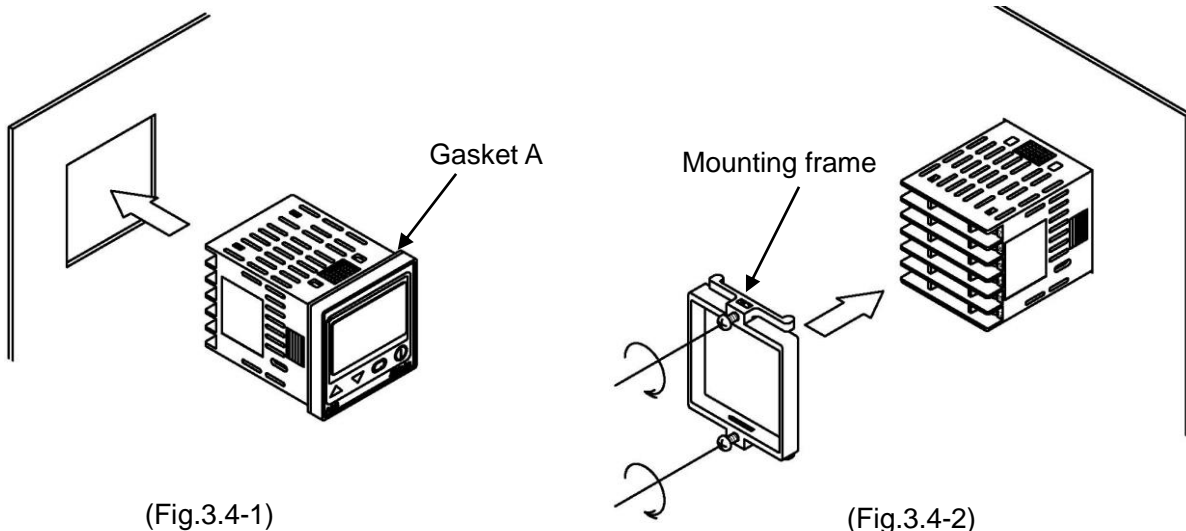

How to remove the mounting frame and unit (Fig. 3.4-3)

(1) Turn the power to the unit OFF, and disconnect all wires before removing the mounting frame.

(2) Insert a flat blade screwdriver between the mounting frame and unit ①.

(3) Slowly push the frame upward using the screwdriver ②, while pushing the unit toward the panel ③.

(4) Repeat Step (2) and slowly push the frame downward using the screwdriver for the other side.

The frame can be removed little by little by repeating these steps.

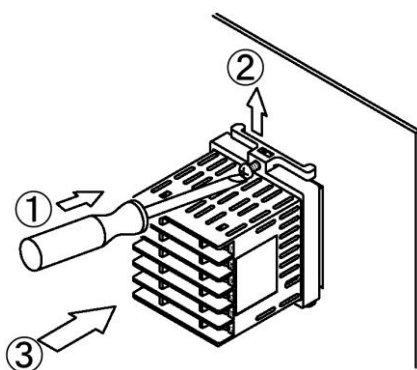

(Fig.3.4-3)

4. Wiring

⚠ Warning

Turn the power supply to the instrument off before wiring or checking.
Working on or touching the terminal with the power switched on may result in severe injury or death due to electrical shock.

4.1 Terminal Arrangement

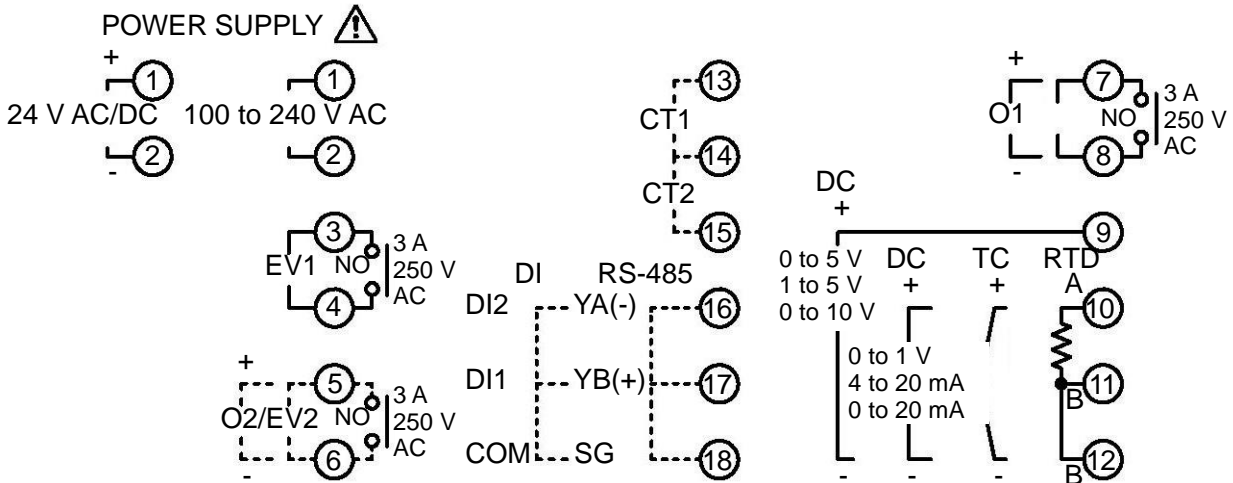

(Fig. 4.1-1)

- **POWER SUPPLY: For a 24 V AC/DC power source, do not confuse polarity when using direct current (DC).**
- EV1: Alarm 1 output
- O2/EV2: Control output OUT2 (D□ option), Alarm 2 output (A2 option) or Heater burnout alarm output (W, W3 option)
- O1: Control output OUT1
- DC: DC voltage, current inputs
(For DC voltage input, + side terminal number differs depending on the voltage input.)
(+ side input terminal number of 0 to 5 V DC, 1 to 5 V DC, 0 to 10 V DC: 9
(+ side input terminal number of 0 to 1 V DC: 10
- TC: Thermocouple input
- RTD: Resistance temperature detector input
- CT1: CT input 1 (W, W3 option)
- CT2: CT input 2 (W3 option)
- DI: Contact input (SM option)
- RS-485: Serial communication RS-485 (C5 option)

4.2 Lead Wire Solderless Terminal

Use a solderless terminal with an insulation sleeve in which an M3 screw fits as shown below. The torque should be 0.63 N•m.

Solderless terminal	Manufacturer	Model	Tightening torque
Y-type	NICHIFU TERMINAL INDUSTRIES CO., LTD.	TMEX1.25Y-3	0.63 N•m
	J.S.T.MFG.CO.,LTD.	VD1.25-B3A	
Ring-type	NICHIFU TERMINAL INDUSTRIES CO., LTD.	TMEX1.25-3	
	J.S.T.MFG.CO.,LTD.	V1.25-3	

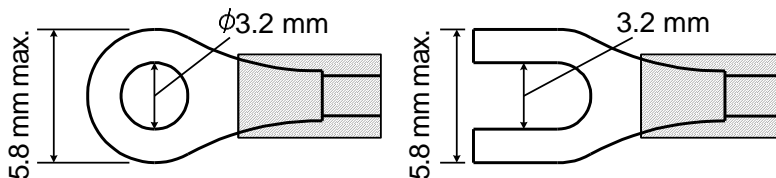

(Fig. 4.2-1)

4.3 Terminal Cover

When using a terminal cover (sold separately), pass terminal wires numbered 7 to 12 into the holes of the terminal cover.

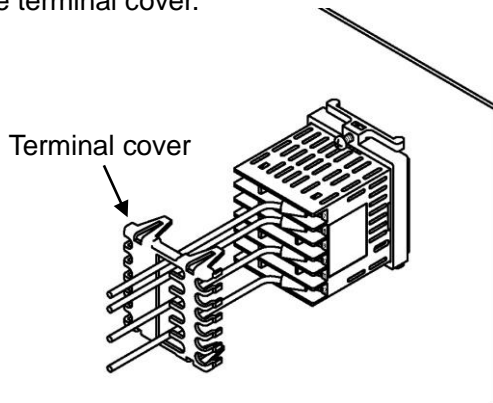

(Fig. 4.3-1)

4.4 Heater Burnout Alarm Output (W, W3 Option) Wiring

This alarm is not usable for detecting heater current under phase control.

Use the CT (current transformer) provided, and pass one lead wire of the heater circuit into the hole of the CT. (Fig. 4.4-1).

When wiring, keep the CT wire away from AC sources or load wires to avoid the external interference.

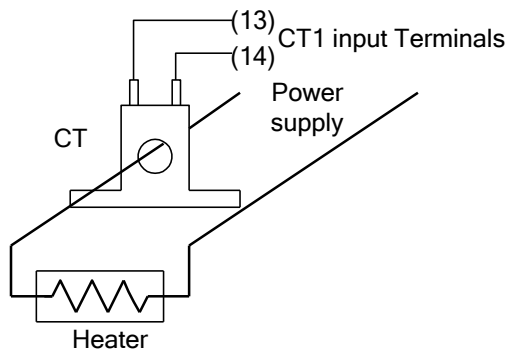

(Fig. 4.4-1)

In the case of 3-phase (W3 option), pass any 2 lead wires of R, S, T into the CT, and connect them to CT1 (13, 14) and CT2 terminals (14, 15). (Fig. 4.4-2)

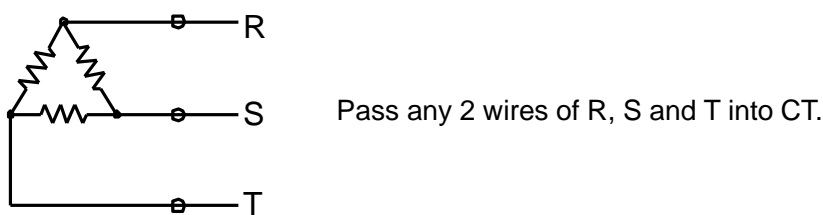

(Fig. 4.4-2)

6. Setup

Setup (setting the Input type, Alarm type, Control action, etc.) should be done before using this controller, according to the user's conditions.

Factory default:

Input: K, -200 to 1370°C, Alarm 1: No alarm action, Reverse (Heating) action

If the user's specification is the same as the factory default value of the instrument, or if user's instrument has already been installed in a system, it is not necessary to set up the controller. Proceed to Section "7. Settings".

6.1 Turn the Power Supply to the ACS-13A ON.

After the power is turned on, the PV Display indicates the input type, and the SV Display indicates the input range high limit value (thermocouple, RTD inputs) or scaling high limit value (DC voltage, current inputs) for approximately 3 seconds. (Table 6.1-1)

During this time, all outputs and the indicators are in OFF status.

Control will then start, indicating the PV (process variable) on the PV Display and SV (desired value) on the SV Display.

While the Control output OFF function is working, the PV Display indicates $\square FF \square$.

(Indication depends on the selection in [Output status when input errors occur]).

(Table 6.1-1)

Sensor Input	°C		°F	
	PV Display	SV Display	PV Display	SV Display
K	K□□□	1370	K□□□	2500
	K□□□	4000	K□□□	7500
J	J□□□	1000	J□□□	1800
R	R□□□	1760	R□□□	3200
S	S□□□	1760	S□□□	3200
B	b□□□	1820	b□□□	3300
E	E□□□	□800	E□□□	1500
T	T□□□	4000	T□□□	7500
N	N□□□	1300	N□□□	2300
PL-II	PL2□	1390	PL2□	2500
C (W/Re5-26)	c□□□	2315	c□□□	4200
Pt100	P□□□	8500	P□□□	15000
	P□□□	□850	P□□□	1500
JPt100	JP□□	5000	JP□□	9000
	JP□□	□500	JP□□	□900
4 to 20 mA DC	420R	Scaling high limit value		
0 to 20 mA DC	020R			
0 to 1 V DC	0□1V			
0 to 5 V DC	0□5V			
1 to 5 V DC	1□5V			
0 to 10 V DC	0□10V			

6.2 Basic Key Operations









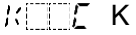
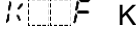
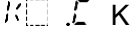
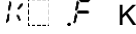
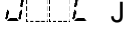
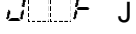
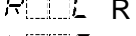
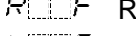
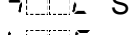
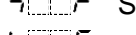
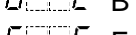
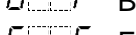
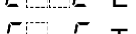
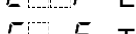
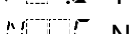
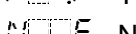
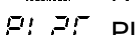
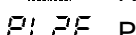
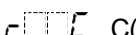
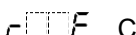
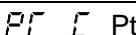
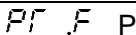
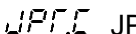
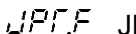
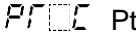
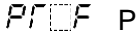
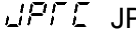
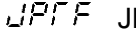
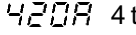

To enter each setting mode, refer to respective setting modes.

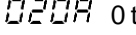
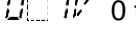
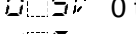
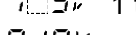
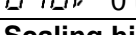







To set or select each setting item, use the \triangle or ∇ key, then register the value with the ↻ key.





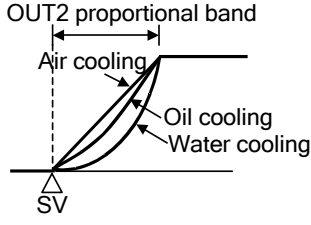



- If the ↻ key is pressed for 3 seconds in any setting mode, the unit will return to PV/SV Display Mode.





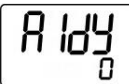

6.3 Setup Mode





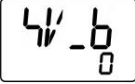
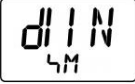

To enter Setup Mode, press and hold the \triangle and ∇ keys (in that order) together for approx. 3 seconds in PV/SV Display Mode.

Character	Name, Function, Setting Range	Factory Default
	Input type <ul style="list-style-type: none"> The input type can be selected from thermocouple (10 types), RTD (2 types), DC current (2 types) and DC voltage (4 types), and the unit °C/°F can be selected as well. When changing the input from DC voltage to other inputs, remove the sensor connected to this controller first, then change the input. If the input is changed with the sensor connected, the input circuit may break. (+) side input terminal number of 0 to 5 V DC, 1 to 5 V DC, 0 to 10 V DC differs from that of 0 to 1 V DC. (+) side input terminal number of 0 to 5 V DC, 1 to 5 V DC, 0 to 10 V DC: 9 (+) side input terminal number of 0 to 1 V DC: 10 	K (-200 to 1370°C)
	K -200 to 1370 °C	 K -320 to 2500 °F
	K -200.0 to 400.0 °C	 K -320.0 to 750.0 °F
	J -200 to 1000 °C	 J -320 to 1800 °F
	R 0 to 1760 °C	 R 0 to 3200 °F
	S 0 to 1760 °C	 S 0 to 3200 °F
	B 0 to 1820 °C	 B 0 to 3300 °F
	E -200 to 800 °C	 E -320 to 1500 °F
	T -200.0 to 400.0 °C	 T -320.0 to 750.0 °F
	N -200 to 1300 °C	 N -320 to 2300 °F
	PL-II 0 to 1390 °C	 PL-II 0 to 2500 °F
	C(W/Re5-26) 0 to 2315 °C	 C(W/Re5-26) 0 to 4200 °F
	Pt100 -200.0 to 850.0 °C	 Pt100 -320.0 to 1500.0 °F
	JPt100 -200.0 to 500.0 °C	 JPt100 -320.0 to 900.0 °F
	Pt100 -200 to 850 °C	 Pt100 -320 to 1500 °F
	JPt100 -200 to 500 °C	 JPt100 -320 to 900 °F
	4 to 20 mA DC -2000 to 10000	
	0 to 20 mA DC -2000 to 10000	
	0 to 1 V DC -2000 to 10000	
	0 to 5 V DC -2000 to 10000	
	1 to 5 V DC -2000 to 10000	
	0 to 10 V DC -2000 to 10000	
	Scaling high limit <ul style="list-style-type: none"> Sets scaling high limit value. Setting range: Scaling low limit value to input range high limit value DC voltage, current inputs: -2000 to 10000 (The placement of the decimal point follows the selection.) 	1370°C
	Scaling low limit <ul style="list-style-type: none"> Sets scaling low limit value. Setting range: Input range low limit value to scaling high limit value DC voltage, current inputs: -2000 to 10000 (The placement of the decimal point follows the selection.) 	-200°C
	Decimal point place <ul style="list-style-type: none"> Selects decimal point place. Available only for DC voltage, current inputs : No decimal point : 1 digit after decimal point : 2 digits after decimal point : 3 digits after decimal point 	No decimal point

Character	Name, Function, Setting Range	Factory Default
	PV filter time constant <ul style="list-style-type: none"> Sets PV filter time constant. If the value is set too high, it affects control results due to the delay of response. Setting range: 0.0 to 10.0 seconds 	0.0 seconds
	OUT1 high limit <ul style="list-style-type: none"> Sets the high limit value of OUT1. Not available if OUT1 is in ON/OFF control Setting range: OUT1 low limit value to 100% (Direct current output type: OUT1 low limit value to 105%) 	100%
	OUT1 low limit <ul style="list-style-type: none"> Sets the low limit value of OUT1. Not available if OUT1 is in ON/OFF control. Setting range: 0% to OUT1 high limit value (Direct current output type: -5% to OUT1 high limit value) 	0%
	OUT1 ON/OFF hysteresis <ul style="list-style-type: none"> Sets ON/OFF hysteresis for OUT1. Available only when OUT1 is in ON/OFF control Setting range: 0.1 to 100.0°C (°F), DC voltage, current inputs: 1 to 1000 (The placement of the decimal point follows the selection.) 	1.0°C
	OUT2 cooling method <ul style="list-style-type: none"> Selects OUT2 action from air, oil and water cooling. Available if the D□ option is ordered. Not available if OUT2 is in ON/OFF control. AIR□: Air cooling (Linear characteristics) oIL□: Oil cooling (1.5th power of the linear characteristics) WAT□: Water cooling (2nd power of the linear characteristics) 	Air cooling  <p>(Fig. 6.3-1)</p>
	OUT2 high limit <ul style="list-style-type: none"> Sets OUT2 high limit value. Available if the D□ option is ordered. Not available if OUT2 is in ON/OFF control. Setting range: OUT2 low limit value to 100% 	100%
	OUT2 low limit <ul style="list-style-type: none"> Sets OUT2 low limit value. Available if the D□ option is ordered. Not available if OUT2 is in ON/OFF control. Setting range: 0% to OUT2 high limit value 	0%
	Overlap band/Dead band <ul style="list-style-type: none"> Sets the overlap band or dead band for OUT1 and OUT2. + Set value: Dead band, -Set value: Overlap band Available when the D□ option is ordered. Setting range: -100.0 to 100.0°C (°F), DC voltage, current inputs: -1000 to 1000 (The placement of the decimal point follows the selection.) 	0.0°C
	OUT2 ON/OFF hysteresis <ul style="list-style-type: none"> Sets ON/OFF hysteresis for OUT2. Available when the D□ option is ordered and when OUT2 is in ON/OFF control. Setting range: 0.1 to 100.0°C (°F), DC voltage, current inputs: 1 to 1000 (The placement of the decimal point follows the selection.) 	1.0°C

Character	Name, Function, Setting Range	Factory Default
	Alarm 1 type <ul style="list-style-type: none"> • Selects an Alarm 1 type. (Refer to '11.4 Alarm Action' on p.31.) • If an alarm type is changed, the alarm value becomes 0 (0.0). <p>---- : No alarm action</p> <p>H--- : High limit alarm</p> <p>L--- : Low limit alarm</p> <p>HL-- : High/Low limits alarm</p> <p>HL d : High/Low limit range alarm</p> <p>RA-- : Process high alarm</p> <p>RL-- : Process low alarm</p> <p>H---M : High limit with standby alarm</p> <p>L---M : Low limit with standby alarm</p> <p>HL---M : High/Low limits with standby alarm</p>	No alarm action
	Alarm 2 (A2) type <ul style="list-style-type: none"> • Selects an Alarm 2 type. (Refer to "11.4 Alarm Action" on p.31.) • If an alarm type is changed, the alarm value becomes 0 (0.0). <p>Available only when Alarm 2 (A2) option is ordered.</p> <ul style="list-style-type: none"> • Selection items are the same as those of Alarm 1. 	No alarm action
	Alarm 1 Energized/De-energized <ul style="list-style-type: none"> • Selects Energized/De-energized status for Alarm 1. (See p.18.) <p>Not available if No alarm action is selected in [Alarm 1 type].</p> <ul style="list-style-type: none"> • NoML : Energized • REVL : De-energized 	Energized
	Alarm 2 Energized/De-energized <ul style="list-style-type: none"> • Selects Energized/De-energized status for Alarm 2. (See p.18.) <p>Available when Alarm 2 (A2) option is ordered.</p> <p>Not available if No alarm action is selected in [Alarm 2 type].</p> <ul style="list-style-type: none"> • Selection items are the same as those of Alarm 1 Energized/De-energized selection. 	Energized
	Alarm 1 hysteresis <ul style="list-style-type: none"> • Sets hysteresis for Alarm 1. <p>Not available if No alarm action is selected in [Alarm 1 type].</p> <ul style="list-style-type: none"> • Setting range: 0.1 to 100.0°C (°F), DC voltage, current inputs: 1 to 1000 (The placement of the decimal point follows the selection.) 	1.0°C
	Alarm 2 hysteresis <ul style="list-style-type: none"> • Sets hysteresis for Alarm 2. <p>Available when Alarm 2 (A2) option is ordered.</p> <p>Not available if No alarm action is selected in [Alarm 2 type].</p> <ul style="list-style-type: none"> • Setting range: 0.1 to 100.0°C (°F), DC voltage, current inputs: 1 to 1000 (The placement of the decimal point follows the selection.) 	1.0°C
	Alarm 1 delay time <ul style="list-style-type: none"> • Sets Alarm 1 action delay time. <p>When setting time has elapsed after the input enters the alarm output range, the alarm is activated.</p> <p>Not available if No alarm action is selected in [Alarm 1 type].</p> <ul style="list-style-type: none"> • Setting range: 0 to 10000 seconds 	0 seconds
	Alarm 2 delay time <ul style="list-style-type: none"> • Sets Alarm 2 action delay time. <p>When setting time has elapsed after the input enters the alarm output range, the alarm is activated.</p> <p>Available when Alarm 2 (A2) option is ordered.</p> <p>Not available if No alarm action is selected in [Alarm 2 type].</p> <ul style="list-style-type: none"> • Setting range: 0 to 10000 seconds 	0 seconds

Character	Name, Function, Setting Range	Factory Default
	SV rise rate <ul style="list-style-type: none"> Sets SV rise rate (rising value for 1 minute). Setting to 0 disables the function. Setting range: 0 to 10000 °C/minute (°F/minute) Thermocouple, RTD inputs with a decimal point: 0.0 to 1000.0 °C/minute (°F/minute) DC voltage, current inputs: 0 to 10000/minute (The placement of the decimal point follows the selection.) 	0 °C/minute
	SV fall rate <ul style="list-style-type: none"> Sets SV fall rate (falling value for 1 minute). Setting to 0 disables the function. Setting range: 0 to 10000 °C/minute (°F/minute) Thermocouple, RTD inputs with a decimal point: 0.0 to 1000.0 °C/minute (°F/minute) DC voltage, current inputs: 0 to 10000/minute (The placement of the decimal point follows the selection.) 	0 °C/minute
	Direct/Reverse control action <ul style="list-style-type: none"> Selects either Reverse (Heating) or Direct (Cooling) control action. HEAR: Reverse (Heating) control action COOL: Direct (Cooling) control action 	Reverse (Heating) action
	AT bias <ul style="list-style-type: none"> Sets bias value for AT(auto-tuning). (Refer to Section "10. AT(Auto-tuning)" on p.29.) Not available for DC voltage or current input. Setting range: 0 to 50°C (0 to 100°F) (Thermocouple, RTD inputs with decimal point: 0.0 to 50.0°C(0.0 to 100.0°F)) 	20°C
	SVTC bias <ul style="list-style-type: none"> SV adds SVTC bias value to the value received by the SVTC command. Available only when the C5 option is ordered Setting range: Converted value of ±20% of the input span DC voltage, current inputs: ±20% of the scaling span (The placement of the decimal point follows the selection.) 	0°C
	Contact input function <ul style="list-style-type: none"> Contact input terminals DI2 can be used for 'Set value memory external selection' or for 'Control output OFF external selection'. See 'Contact input function selection' on p.18. If 'Auto/Manual control function' is selected in [OUT/OFF key function], externally Auto/Manual control can be switched. Available only when the SM option is ordered. 4M: Set value memory external selection OFF1: Control output OFF external selection 1 (SV and SV2 can be switched) OFF2: Control output OFF external selection 2 	Set value memory external selection
	Output status when input errors occur <ul style="list-style-type: none"> Selects the output status for OUT1 and OUT2 when DC voltage or current input is overscale or underscale. Available for Direct current and voltage inputs, and Direct current output. OFF: Outputs OFF (4 mA) or OUT1 (OUT2) low limit. ON: Outputs a value between OFF (4 mA) and ON (20 mA), or between OUT1 (OUT2) low limit value and OUT1 (OUT2) high limit value, depending on a deviation. 	Outputs OFF (4 mA) or OUT1 (OUT2) low limit.
	OUT/OFF key function <ul style="list-style-type: none"> Selects whether OUT/OFF key is used for 'Control output OFF function' or for 'Auto/Manual control function'. OFF: Control output OFF function MANU: Auto/Manual control function 	Control output OFF function

Character	Name, Function, Setting range	Factory Default
	Backlight selection <ul style="list-style-type: none"> • Selects the display to backlight. • <i>ALL</i>: All (displays and indicators) are backlit. • <i>PV</i>: PV Display is backlit. • <i>SV</i>: SV Display is backlit. • <i>Ac</i>: Action indicators are backlit. • <i>PV SV</i>: PV and SV displays are backlit. • <i>PV Ac</i>: PV Display and Action indicators are backlit. • <i>SV Ac</i>: SV Display and Action indicators are backlit. 	All are backlit
	PV color <ul style="list-style-type: none"> • Selects PV Display color. See 'PV Display color selection' on p.19. • <i>GRN</i>: Green • <i>REd</i>: Red • <i>ORC</i>: Orange • <i>ALCR</i>: When Alarm 1 or Alarm 2 is ON, PV color turns from green to red. • <i>ALOR</i>: When Alarm 1 or Alarm 2 is ON, PV color turns from orange to red. • <i>PVCR</i>: PV color changes continuously (Orange → Green → Red). • <i>APCR</i>: PV color changes continuously (Orange → Green → Red), and at the same time Alarm 1 or Alarm 2 is ON (Red). 	Red
	PV color range <ul style="list-style-type: none"> • When <i>PVCR</i> (PV color changes continuously) or <i>APCR</i> (PV color changes continuously + Alarm 1 or Alarm 2 is ON) is selected in [PV color], the value of green PV color range can be set. See 'PV Display color selection' on p.19. • Setting range: 0.1 to 100.0°C (°F), DC voltage, current inputs: 1 to 1000 (The placement of the decimal point follows the selection.) 	5.0°C
	Backlight time <ul style="list-style-type: none"> • Sets time to backlight from no operation status until backlight is switched off. When set to 0, the backlight remains ON. Backlight relights by pressing any key while backlight is OFF. • Setting range: 0 to 99 minutes 	0 minutes
	Indication when output OFF <ul style="list-style-type: none"> • Selects the indication when control output is OFF. • <i>oFF</i>: OFF indication • <i>RoFF</i>: No indication • <i>PV</i>: PV indication • <i>PV AL</i>: PV indication+ Alarm output (Alarm 1, Alarm 2, Heater burnout alarm) active 	OFF indication
	OUT1 rate-of-change <ul style="list-style-type: none"> • Sets changing value of OUT1 MV for 1 second. • Not available when set to 0, or if OUT1 is in ON/OFF control. See 'OUT1 rate-of-change' on p.19. • Setting range: 0 to 100 %/second 	0 %/second

[Alarm action Energized/De-energized]

When [Alarm Energized (NORM)] is selected, the alarm output (terminals 3 and 4, or 5 and 6) is conductive (ON) while the alarm output indicator is lit.

The alarm output is not conductive (OFF) while the alarm output indicator is not lit.

When [Alarm De-energized (REV)] is selected, the alarm output (terminals 3 and 4, or 5 and 6) is not conductive (OFF) while the alarm output indicator is lit.

The alarm output is conductive (ON) while the alarm output indicator is not lit.

High limit alarm (when Energized is set) High limit alarm (when De-energized is set)

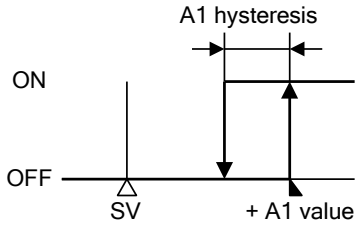

(Fig. 6.3-2)

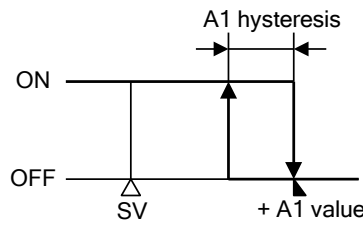

(Fig. 6.3-3)

A1: Alarm 1
For Alarm 2(A2), read "A2" for "A1".

[Contact input function selection]

Actions differ depending on the selection in [OUT/OFF key function] in Setup Mode.

- When **Control output OFF function (OFF)** is selected in [OUT/OFF key function]

(Table 6.3-1)

Connecting terminal No.		Contact input function		
17 and 18 (DI1-COM)	16 and 18 (DI2-COM)	Set value memory external selection (LM)	Control output OFF external selection 1 (OFF)	Control output OFF external selection 2 (OFF2)
Open	Open	SV	SV	SV
Closed	Open	SV2	SV2	
Open	Closed	SV3	Control output OFF	Control output OFF
Closed	Closed	SV4		

- When **Auto/Manual control (MANU)** is selected in [OUT/OFF key function]

(Table 6.3-2)

Connecting terminal No.		Contact input function		
17 and 18 (DI1-COM)	16 and 18 (DI2-COM)	Set value memory external selection (LM)	Control output OFF external selection 1 (OFF)	Control output OFF external selection 2 (OFF2)
Open	Open	SV	SV (Automatic control)	SV (Automatic control)
Closed	Open	SV2	SV2 (Automatic control)	
Open	Closed	SV3	Manual control	Manual control
Closed	Closed	SV4		

[PV Display color selection]

(Table 6.3-3)

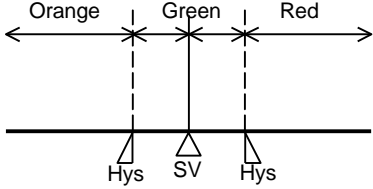
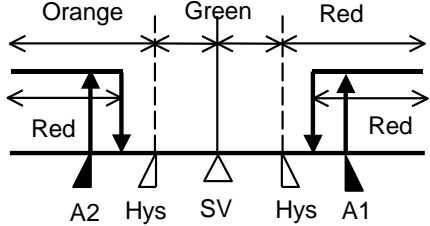
PV color selection		PV color
<i>GRN</i>	Green	Constantly green
<i>RED</i>	Red	Constantly red
<i>ORNG</i>	Orange	Constantly orange
<i>ALOR</i>	When Alarm 1 or Alarm 2 is ON: Green → Red	When alarm is OFF: Green When Alarm 1 or Alarm 2 is ON, the PV color turns from green to red.
<i>ALOR</i>	When Alarm 1 or Alarm 2 is ON: Orange → Red	When alarm is OFF: Orange When Alarm 1 or Alarm 2 is ON, the PV color turns from orange to red.
<i>PVCR</i>	PV color changes continuously (Orange → Green → Red)	PV color changes depending on the color range setting. <ul style="list-style-type: none"> • PV is lower than [SV-PV color range]: Orange • PV is within [SV±PV color range]: Green • PV is higher than [SV+PV color range]: Red  <p style="text-align: right;">(Fig. 6.3-4)</p> <p style="text-align: center;">Hys: Set point of PV color range</p>
<i>APCR</i>	PV color changes continuously (Orange → Green → Red), and at the same time Alarm 1 or Alarm 2 is ON (Red).	PV color changes depending on the color range setting. When Alarm 1 or Alarm 2 is ON, PV Display turns red. <ul style="list-style-type: none"> • PV is lower than [SV-PV color range]: Orange • PV is within [SV±PV color range]: Green • PV is higher than [SV+PV color range]: Red • Alarm 1 or Alarm 2 is ON: Red  <p style="text-align: right;">(Fig. 6.3-5)</p> <p style="text-align: center;"> Hys: Set point of PV color range A1: Alarm 1 value (High limit alarm) A2: Alarm 2 value (Low limit alarm) </p>

[OUT1 rate-of-change]

For Heating control, if PV is lower than SV, output is generally turned from OFF to ON as shown in (Fig.6.3-6). If OUT1 rate-of-change is set, the output can be changed by the rate-of-change (Fig.6.3-7).

This control is suitable for high temperature heaters (which are made from molybdenum, tungsten or platinum, etc., and used at approx. 1500 to 1800°C) which are easily burnt out from turning on electricity rapidly.

● Usual output

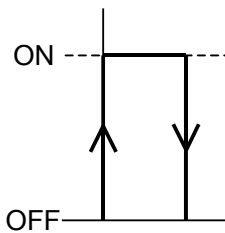

(Fig.6.3-6)

● Output when Output rate-of-change is set

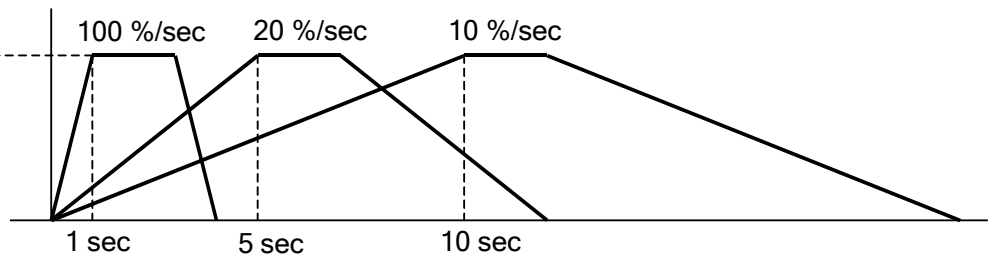



(Fig.6.3-7)

7. Settings



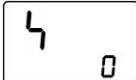

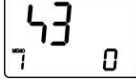
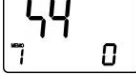

7.1 Main Setting Mode

To enter Main Setting Mode, press the  key in PV/SV Display Mode.

Character	Name, Function, Setting Range	Factory Default
	SV • Sets SV. • Setting range: Scaling low limit to Scaling high limit	0°C
	SV2 • Sets SV2. Available when the SM option is ordered. Not available if the C5 option is ordered, or if 'Control output OFF external selection 2' is selected in [Contact input function]. • Setting range: Scaling low limit to Scaling high limit	0°C
	SV3 • Sets SV3. Available when the SM option is ordered. Not available if the C5 option is ordered, or if 'Control output OFF external selection 1 or 2' is selected in [Contact input function]. • Setting range: Scaling low limit to Scaling high limit	0°C
	SV4 • Sets SV4. Available when the SM option is ordered. Not available if the C5 option is ordered, or if 'Control output OFF external selection 1 or 2' is selected in [Contact input function]. • Setting range: Scaling low limit to Scaling high limit	0°C

7.2 Sub Setting Mode

To enter Sub Setting Mode, press and hold the \triangle and \odot keys (in that order) together in PV/SV Display Mode.

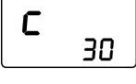
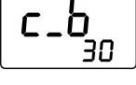
Character	Name, Function, Setting Range	Factory Default
	AT/Auto-reset <ul style="list-style-type: none"> • Selects AT (auto-tuning) Perform/Cancel (PID control) or Auto-reset Perform/Cancel (P, PD control). Not available for ON/OFF or PI control action. • If the AT is cancelled during the process, P, I and D values revert to the values before AT was performed. • AT will be forced to stop if it has not been completed within 4 hours. • Auto-reset is cancelled in approximately 4 minutes. It cannot be released while performing this function. • -----: AT/Auto-reset Cancel AT \square / RSET: AT/Auto-reset Perform 	-----
	OUT1 proportional band <ul style="list-style-type: none"> • Sets the proportional band for OUT1. OUT1 becomes ON/OFF control when set to 0 or 0.0. • Setting range: 0 to 1000°C (2000°F) Thermocouple, RTD inputs with decimal point: 0.0 to 1000.0°C (1999.9°F) (DC voltage, current inputs: 0.0 to 100.0%) 	10°C
	OUT2 proportional band <ul style="list-style-type: none"> • Sets the proportional band for OUT2. OUT2 becomes ON/OFF control when set to 0.0. Available if the D \square option is ordered. Not available if OUT1 is in ON/OFF control. • Setting range: 0.0 to 10.0 times (Multiplied value of OUT1 proportional band) 	1.0 times
	Integral time <ul style="list-style-type: none"> • Sets integral time for OUT1. Setting the value to 0 disables the function. Not available if OUT1 is in ON/OFF control. Auto-reset can be performed when PD is control action (I=0). • Setting range: 0 to 1000 seconds 	200 seconds
	Derivative time <ul style="list-style-type: none"> • Sets derivative time for OUT1. Setting the value to 0 disables the function. Not available if OUT1 is in ON/OFF control. • Setting range: 0 to 300 seconds 	50 seconds
	ARW <ul style="list-style-type: none"> • Sets anti-reset windup (ARW) for OUT1. Available only when PID is control action. • Setting range: 0 to 100% 	50%
	OUT1 proportional cycle <ul style="list-style-type: none"> • Sets proportional cycle for OUT1. For relay contact output, if the proportional cycle time is decreased, the frequency of the relay action increases, and the life of the relay contact is shortened. Not available for Direct current output type, or if OUT1 is in ON/OFF control. • Setting range: 1 to 120 seconds 	Relay contact: 30 seconds Non-contact voltage: 3 seconds
	OUT2 proportional cycle <ul style="list-style-type: none"> • Sets proportional cycle for OUT2. For relay contact output, if the proportional cycle time is decreased, the frequency of the relay action increases, and the life of the relay contact is shortened. Available if the D \square option is ordered. Not available if OUT2 is in ON/OFF control. • Setting range: 1 to 120 seconds 	Relay contact: 30 seconds Non-contact voltage: 3 seconds

Character	Name, Function, Setting Range	Factory Default
	Alarm 1 value <ul style="list-style-type: none"> Sets action point for Alarm 1 output. Setting the value to 0 or 0.0 disables the function (except Process high alarm and Process low alarm). Not available if No alarm action is selected in [Alarm 1 type]. Refer to (Table 7.2-1). 	0°C
	Alarm 2 value <ul style="list-style-type: none"> Sets action point for Alarm 2 output. Setting the value to 0 or 0.0 disables the function (except Process high alarm and Process low alarm). Available if Alarm 2 (A2) option is ordered. Not available if No alarm action is selected in [Alarm 2 type]. Refer to (Table 7.2-1). 	0°C
 CT1 current value are alternately indicated on the PV Display.	Heater burnout alarm value <ul style="list-style-type: none"> Sets the heater current value for Heater burnout alarm. Setting to 0.0 disables the alarm. CT1 current value and character <i>H</i> are indicated alternately on the PV Display. When OUT1 is ON, the CT1 current value is updated. When OUT1 is OFF, the ACS-13A memorizes the previous value when OUT1 was ON. Upon returning to set limits, the alarm will stop. Available only when the W or W3 option is ordered. Rated current: 20 A (0.0 to 20.0 A), 50 A (0.0 to 50.0 A) 	0.0 A
 CT2 current value are alternately indicated on the PV Display.	Heater burnout alarm 2 value <ul style="list-style-type: none"> Sets the heater current value for Heater burnout alarm 2. Setting to 0.0 disables the alarm. CT2 current value and characters <i>H2</i> are indicated alternately on the PV Display. When OUT1 is ON, the CT2 current value is updated. When OUT1 is OFF, the ACS-13A memorizes the previous value when OUT1 was ON. Upon returning to set limits, the alarm will stop. Available only when the W3 option is ordered. Rated current: 20 A (0.0 to 20.0 A), 50 A (0.0 to 50.0 A) 	0.0 A

(Table 7.2-1)





Alarm Type	Setting Range	
High limit alarm	-(Input span) to input span°C (°F)	*1
Low limit alarm	-(Input span) to input span°C (°F)	*1
High/Low limits alarm	0 to input span°C (°F)	*1
High/Low limit range alarm	0 to input span°C (°F)	*1
Process high alarm	Input range low limit value to input range high limit value	*2
Process low alarm	Input range low limit value to input range high limit value	*2
High limit with standby alarm	-(Input span) to input span°C (°F)	*1
Low limit with standby alarm	-(Input span) to input span°C (°F)	*1
High/Low limits with standby alarm	0 to input span°C (°F)	*1



*1: For DC voltage, current inputs, the input span is the same as the scaling span.

*2: For DC voltage, current inputs, input range low (or high) limit value is the same as scaling low (or high) limit value.

7.3 Auxiliary Function Setting Mode

To enter Auxiliary Function Setting Mode, press and hold the ∇ and \odot keys (in that order) together for 3 seconds in PV/SV Display Mode.

Character	Name, Function, Setting Range	Factory Default
	Set value lock <ul style="list-style-type: none"> Locks the set values to prevent setting errors. The setting item to be locked depends on the selection. When Lock 1 or Lock 2 is selected, AT and Auto-reset cannot be carried out. ---- (Unlock): All set values can be changed. Loc 1 (Lock 1): None of the set values can be changed. Loc 2 (Lock 2): Only Main Setting Mode can be changed. Loc 3 (Lock 3): All set values except input type can be changed. However, changed values revert to their previous value after power is turned off because they are not saved in the non-volatile IC memory. Do not change any setting item in Setup Mode. If any item in Setup Mode is changed, it will affect other setting items such as the SV and Alarm value. 	Unlock
	Sensor correction <ul style="list-style-type: none"> Sets the correction value for the sensor. This corrects the input value from the sensor. When a sensor cannot be set at the exact location where control is desired, the sensor-measured temperature may deviate from the temperature in the controlled location. When using plural controllers, sometimes the measured temperatures (PV) do not concur due to differences in sensor accuracy or dispersion of load capacities. In such a case, the control can be set at the desired temperature by adjusting the input value of sensors. However, it is effective within the input rated range regardless of the sensor correction value. PV after sensor correction = Current PV + (Sensor correction value) Setting range: -100.0 to 100.0°C (°F) DC voltage, current inputs: -1000 to 1000 (The placement of the decimal point follows the selection.) 	0.0°C
	Communication protocol <ul style="list-style-type: none"> Selects communication protocol. Available when C5 option is ordered. Not available if the SM option is ordered. NoML: Shinko protocol ModA: MODBUS ASCII mode ModR: MODBUS RTU mode 	Shinko protocol
	Instrument number <ul style="list-style-type: none"> Sets the instrument number. The instrument numbers should be set one by one when multiple instruments are connected in Serial communication, otherwise communication is impossible. Available when C5 option is ordered. Not available if the SM option is ordered. Setting range: 0 to 95 	0
	Communication speed <ul style="list-style-type: none"> Selects a communication speed equal to that of the host computer. Available when C5 option is ordered. Not available if the SM option is ordered. 24: 2400 bps 48: 4800 bps 96: 9600 bps 192: 19200 bps 	9600 bps

Character	Name, Function, Setting Range	Factory Default
	<p>Data bit/Parity</p> <ul style="list-style-type: none"> • Selects data bit and parity. • Available when C5 option is ordered. Not available if the SM option is ordered. • <i>8NoN</i> : 8 bits/No parity <i>7NoN</i> : 7 bits/No parity <i>8EVN</i> : 8 bits/Even parity <i>7EVN</i> : 7 bits/Even parity <i>8odd</i> : 8 bits/Odd parity <i>7odd</i> : 7 bits/Odd parity 	7 bits/Even parity
	<p>Stop bit</p> <ul style="list-style-type: none"> • Selects the stop bit. • Available when C5 option is ordered. Not available if the SM option is ordered. • <input type="checkbox"/> <i>1</i>: 1 bit <input type="checkbox"/> <i>2</i>: 2 bits 	1 bit

8. Operation

8.1 Starting Operation

After the unit is mounted to the control panel and wiring is completed, operate the unit following the procedure below.

(1) Turn the power supply to the ACS-13A ON.

After the power is turned on, the PV Display indicates the input type, and the SV Display indicates the input range high limit value (for thermocouple, RTD inputs) or scaling high limit value (for DC voltage, current inputs) for approximately 3 seconds. See (Table 8.1-1).

During this time, all outputs and the indicators are in OFF status.

Control will then start, indicating the PV (process variable) on the PV Display and SV (desired value) on the SV Display.

While the Control output OFF function is working, PV Display indicates $\square FF \square$. (Indication of the PV Display depends on the selection in [Indication when output OFF].)

(Table 8.1-1)

Sensor input	°C		°F	
	PV Display	SV Display	PV Display	SV Display
K	K□□□	1370	K□□□	2500
J	K□□□	4000	K□□□	7500
R	J□□□	1000	J□□□	1800
S	R□□□	1760	R□□□	3200
B	S□□□	1760	S□□□	3200
E	b□□□	1820	b□□□	3300
T	E□□□	□800	E□□□	1500
N	T□□□	4000	T□□□	7500
PL-II	N□□□	1300	N□□□	2300
C (W/Re5-26)	PL2□	1390	PL2□	2500
	□□□□	23 15	□□□□	4200
Pt100	P□□□	8500	P□□□	15000
JPt100	P□□□	□850	P□□□	1500
	J□□□	5000	J□□□	9000
	J□□□	□500	J□□□	□900
4 to 20 mA DC	420A	Scaling high limit value		
0 to 20 mA DC	020A			
0 to 1 V DC	0□V			
0 to 5 V DC	0□SV			
1 to 5 V DC	1□SV			
0 to 10 V DC	0 10V			

(2) Input each set value. Enter each set value. Refer to “7. Settings”.

(3) Turn the load circuit power ON.

Control action starts so as to keep the control target at the SV.

Main Setting Mode (When setting the SV to 100°C):

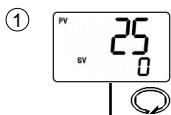

Proceed to Main Setting Mode.

Press the key in PV/SV Display Mode. The unit proceeds to Main Setting Mode.

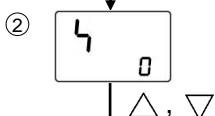

Set SV.

Set SV with the \triangle or ∇ key.

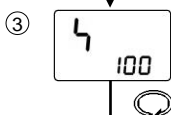

Register the SV.

Register the SV by pressing the key. The unit reverts to PV/SV Display Mode.



Control starts.

Control starts so as to keep the measuring temperature at 100°C.

8.2 Control Output OFF Function

The control action and output of an instrument (or instruments) can be turned OFF without turning OFF their power supplies using this function.

To turn the control output OFF, press the ① key for approximately 1 second.

[OFF] is indicated on the PV Display while the function is working.

(However, indication of the PV Display depends on the selection in [Indication when output OFF].)

Once the Control output OFF function is enabled, the function cannot be cancelled even if the power to the instrument is turned OFF and ON again.

To cancel the function, press the ① key again for approx. 1 second.

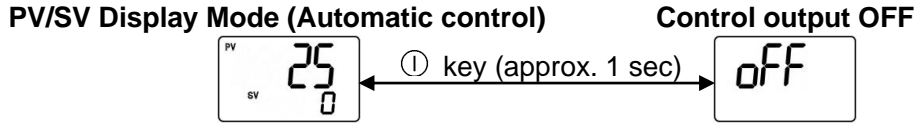

8.3 Auto/Manual Control Switching

Select 'Auto/Manual control function' in [OUT/OFF key function] in Setup Mode.

By pressing the ① key in PV/SV Display Mode, Auto/Manual control function can be switched.

If control action is switched from automatic to manual and vice versa, the balanceless-bumpless function works to prevent a sudden change in the output MV.

When automatic control is switched to manual control, the MEMO Display indicates [M].

The output MV on the SV Display can be increased or decreased by pressing the Δ or ∇ key to perform the control.

By pressing the ① key again, the unit reverts to PV/SV Display Mode (automatic control).

Whenever the power to the controller is turned on, automatic control starts.

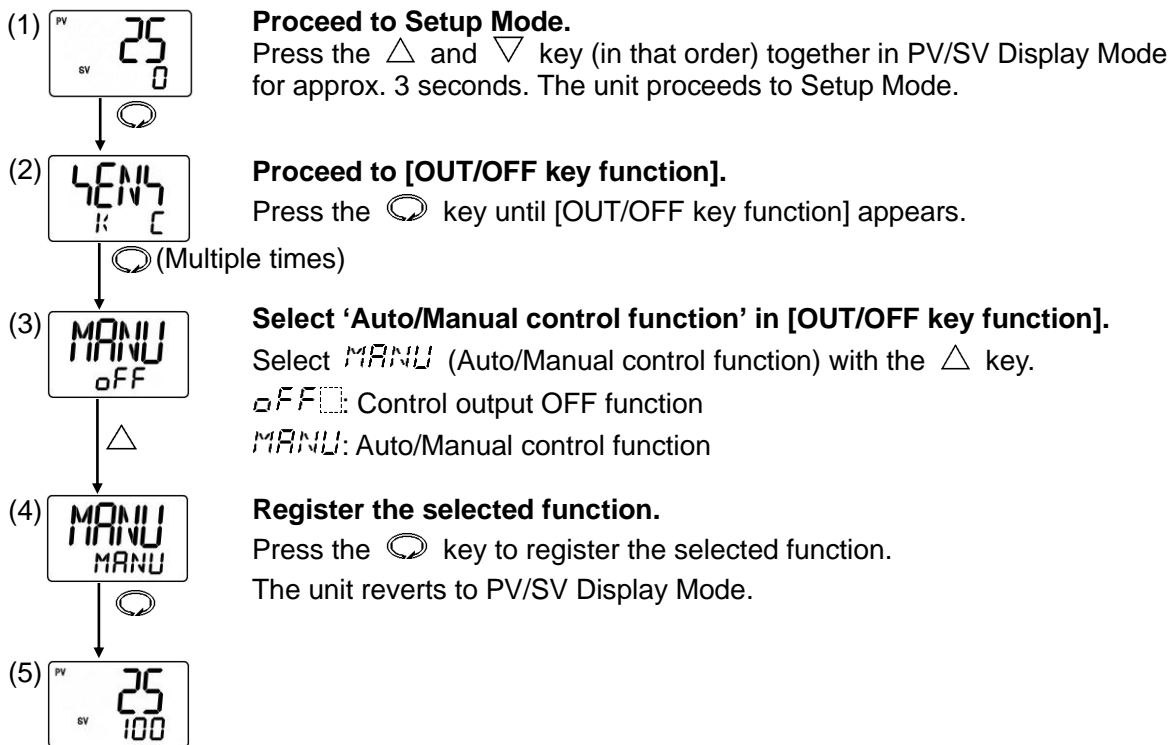

● Selecting 'Auto/Manual control function' in [OUT/OFF key function]:

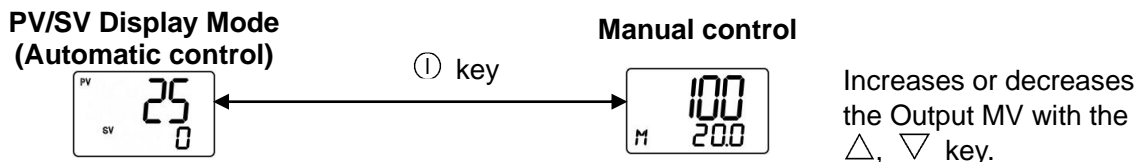

● Switching from Automatic to Manual control, and vice versa:



8.4 Indicating the Output MV

To indicate the output MV, press the  key for approximately 3 seconds in PV/SV Display Mode. The MEMO Display indicates [P^M]. By pressing the  key again, the unit reverts to PV/SV Display Mode.

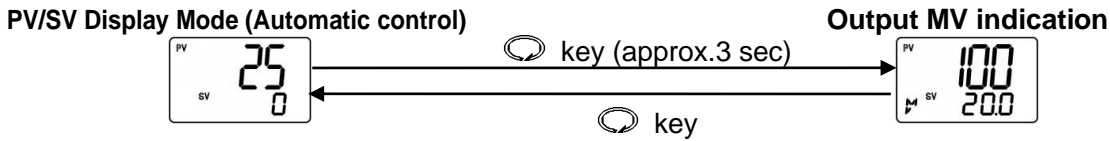

8.5 AT/Auto-reset Perform, AT Cancel



In order to set each value of P, I, D and ARW automatically, the AT process should be made to fluctuate to obtain an optimal value.

AT/Auto-reset can be performed or cancelled in [AT/Auto-reset] in Sub Setting Mode.



Auto-reset can be performed when P or PD is control action. Auto-reset ends 4 minutes after starting.

It cannot be released while performing this function.







How to perform AT/Auto-reset

- (1) Enter Sub Setting Mode by pressing the Δ and  keys (in that order) together in PV/SV Display Mode. [AT/Auto-reset] selection item appears.
- (2) Select AT/Auto-reset Perform [AT ] with the Δ key, and press the  key. AT/Auto-reset will initiate. While performing AT/Auto-reset, the AT indicator is flashing. AT will be forced to stop if it has not been completed within 4 hours. Auto-reset is finished in approximately 4 minutes. It cannot be cancelled while performing this function.

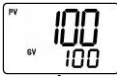
How to cancel AT (Auto-tuning)

- (1) Enter Sub Setting Mode by pressing the Δ and  keys (in that order) together in PV/SV Display Mode. [AT/Auto-reset] selection item appears.
- (2) Select AT/Auto-reset Cancel [$- - - -$] with the ∇ key, and press the  key. AT will stop. If AT is cancelled during this process, each value of P, I, D and ARW reverts to the values before the AT was performed.

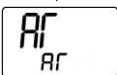
AT Perform/Cancel (in PID control):

- (1)  **Proceed to Sub Setting Mode.**
Press the Δ and  keys (in that order) together in PV/SV Display Mode. The unit proceeds to Sub Setting Mode.
- (2)  **Select AT Perform/Cancel.**
Select AT  (Perform) with the Δ , or select $- - - -$ (Cancel) with the ∇ .
 $- - - -$: AT Cancel
 AT : AT Perform
- (3)  **Confirm AT Perform/Cancel.**
Press the  key. The unit reverts to PV/SV Display Mode.
- (4)  **AT Perform/Cancel**
While AT is performing, the AT indicator flashes, and it turns off if AT is cancelled.

9. Auto-reset

Auto-reset is performed to correct the offset at the point at which PV indication is stabilized within the proportional band during the PD control. Since the corrected value is internally memorized, it is not necessary to perform the auto-reset again as long as the process is the same. However, when OUT1 proportional band (P) is set to 0 or 0.0, the corrected value is cleared.

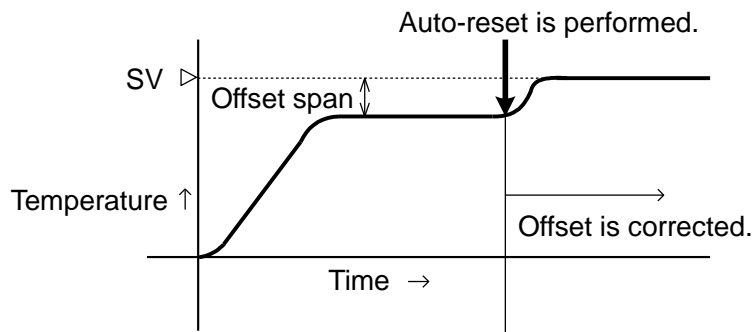

(Fig. 9-1)

10. AT (Auto-tuning)

In order to set each value of P, I, D and ARW automatically, the AT process should be made to fluctuate to obtain an optimal value. One of 3 types of fluctuation below is automatically selected. For DC voltage, current inputs, the AT process will fluctuate around the SV for conditions of [1], [2] and [3] below.

⚠ Notice

- Perform the AT during the trial run.
- During the AT, none of the setting items can be set.
- If power failure occurs during the AT, the AT stops.
- Sometimes the AT process will not fluctuate if AT is performed at or near room temperature. Therefore, AT might not finish normally.

[1] If there is a large difference between the SV and PV as the temperature is rising

When AT bias is set to 20°C, the AT process will fluctuate at the temperature 20°C lower than the SV.

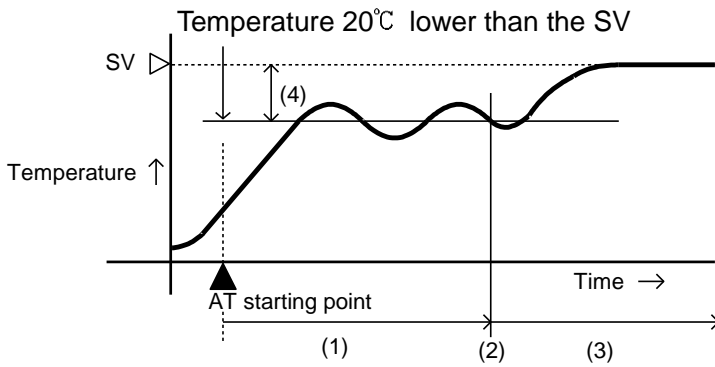

(Fig. 10-1)

- (1) Calculates PID constant.
- (2) PID constant calculated
- (3) Controlled by the PID constant set by AT.
- (4) AT bias value

[2] When the control is stable

The AT process will fluctuate around the SV.

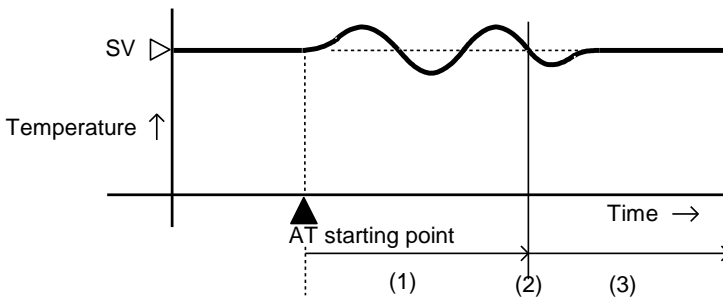

(Fig. 10-2)

- (1) Calculates PID constant.
- (2) PID constant calculated
- (3) Controlled by the PID constant set by AT.

[3] If there is a large difference between the SV and PV as the temperature is falling

When AT bias is set to 20°C, the AT process will fluctuate at the temperature 20°C higher than the SV.

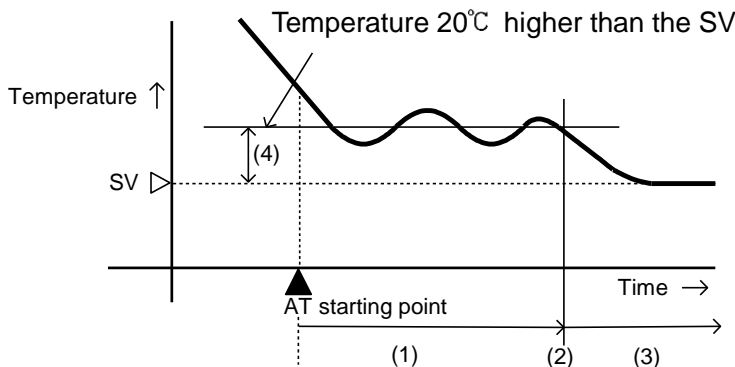

(Fig. 10-3)

- (1) Calculates PID constant.
- (2) PID constant calculated
- (3) Controlled by the PID constant set by AT.
- (4) AT bias value

11. Action Explanation

11.1 OUT1 Action

	Reverse (Heating) action	Direct (Cooling) action
Control action		
Relay contact output	<p>Cycle action is performed according to deviation.</p>	<p>Cycle action is performed according to deviation.</p>
Non-contact voltage output	<p>Cycle action is performed according to deviation.</p>	<p>Cycle action is performed according to deviation.</p>
Direct current output	<p>Changes continuously according to deviation.</p>	<p>Changes continuously according to deviation.</p>
Indicator (O1) Green		

: Turns ON or OFF.

11.2 OUT1 ON/OFF Control Action

	Reverse (Heating) action	Direct (Cooling) action
Control action		
Relay contact output		
Non-contact voltage output		
Direct current output		
Indicator (O1) Green		

: Turns ON or OFF.

11.3 Heater Burnout Alarm Action

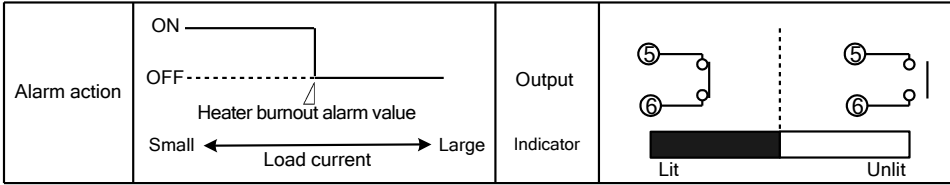

If Heater burnout alarm and Alarm 2 (A2) option are equipped together, they utilize common output (EV2) terminals.

11.4 Alarm Action

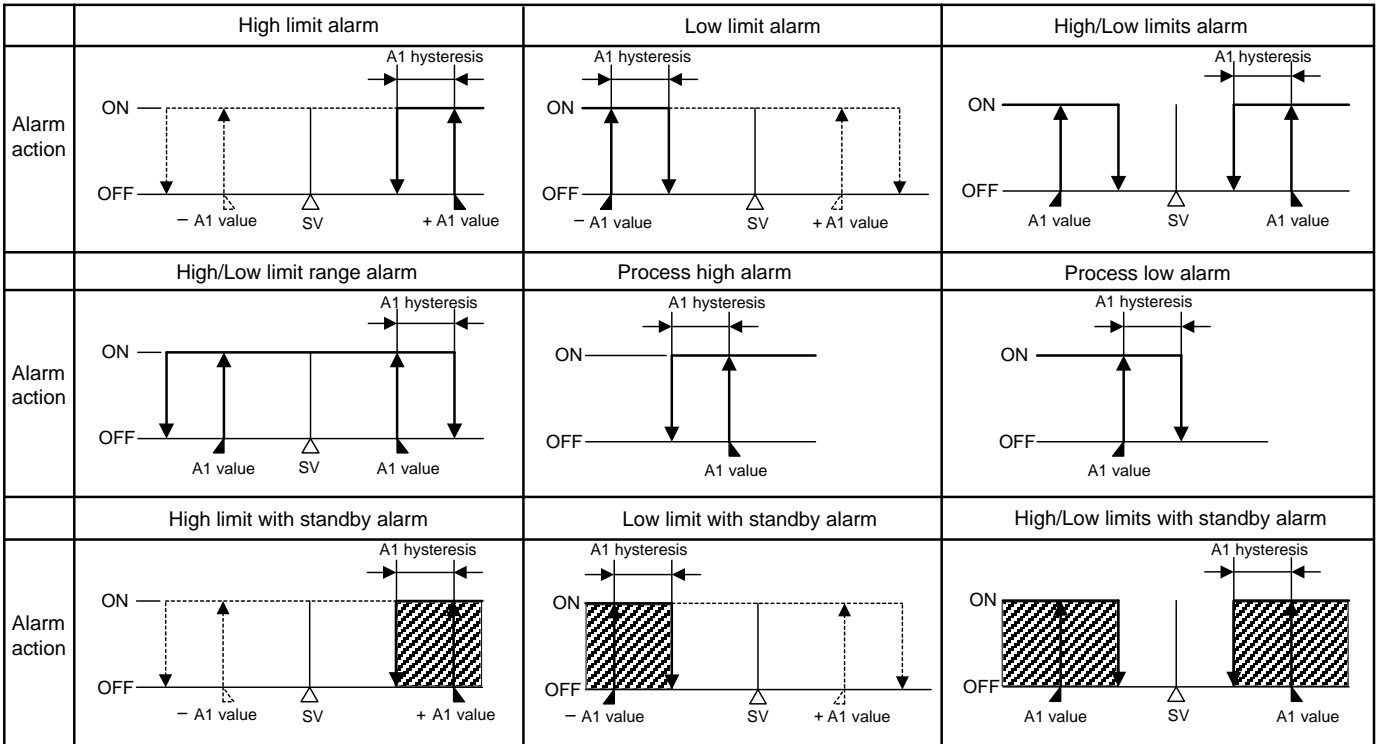

: Alarm output is in standby.

“A1” means Alarm 1. For Alarm 2 (A2), read “A2” for “A1”.

EV1 indicator is for Alarm 1, and EV2 indicator is for Alarm 2.

EV1 indicator lights when output terminals 3 and 4 are closed (ON), and turns off when they are open (OFF).

EV2 indicator lights when output terminals 5 and 6 are closed (ON), and turns off when they are open (OFF).

11.5 OUT2 (Heating/Cooling Control) Action

Control action	<p>ON ——— Heating action ——— ON OFF - - - - - (Cooling action) - - - - - OFF</p> <p>Heating P-band (Cooling P-band)</p> <p>SV</p>		
Relay contact output (OUT1)	<p>Cycle action is performed according to deviation.</p>		
Non-contact voltage output (OUT1)	<p>+ (7) 12 V DC - (8)</p> <p>+ (7) 12/0 V DC - (8)</p> <p>+ (7) 0 V DC - (8)</p> <p>Cycle action is performed according to deviation.</p>		
Direct current output (OUT1)	<p>+ (7) 20 mA DC - (8)</p> <p>+ (7) 20 to 4 mA DC - (8)</p> <p>+ (7) 4 mA DC - (8)</p> <p>Changes continuously according to deviation.</p>		
Relay contact output (OUT2)	<p>Cycle action is performed according to deviation.</p>		
Non-contact voltage output (OUT2)	<p>+ (5) 0 V DC - (6)</p> <p>+ (5) 12/0 V DC - (6)</p> <p>+ (5) 12 V DC - (6)</p> <p>Cycle action is performed according to deviation.</p>		
Indicator (O1)	<p>Lit Unlit</p>		
Indicator (O2)	<p>Unlit Lit</p>		

: Alternates between ON (lit) and OFF (unlit).

————: Represents Heating control action.

- - - - -: Represents Cooling control action.

11.6 OUT2 (Heating/Cooling Control) Action (When Setting Dead Band)

Control action			
Relay contact output (OUT1)	<p>Cycle action is performed according to deviation.</p>		
Non-contact voltage output (OUT1)	<p>Cycle action is performed according to deviation.</p>		
Direct current output (OUT1)	<p>Changes continuously according to deviation.</p>		
Relay contact output (OUT2)	<p>Cycle action is performed according to deviation.</p>		
Non-contact voltage output (OUT2)	<p>Cycle action is performed according to deviation.</p>		
Indicator (O1)			
Indicator (O2)			

: Alternates between ON (lit) and OFF (unlit).

————: Represents Heating control action.

- - - - : Represents Cooling control action.

12. Specifications

12.1 Standard Specifications

Mounting method:	Flush
Setting method:	Input system using membrane sheet key
Display	PV Display: 11-segment backlight LCD Red/Green/Orange, character size 12.0 x 5.4 mm (H x W)
	SV Display: 11-segment backlight LCD Green, character size 6.0 x 3.5 mm (H x W)
	MEMO Display: 11-segment backlight LCD Green, character size 4.8 x 2.8 mm (H x W)
	Indicators: Backlight Orange

Accuracy (Setting and Indication):

Thermocouple:	Within $\pm 0.2\%$ of each input span ± 1 digit, or within $\pm 2^\circ\text{C}$ (4°F), whichever is greater
	However, R, S inputs, 0 to 200°C (32 to 392°F): Within $\pm 6^\circ\text{C}$ (12°F)
	B input, 0 to 300°C (32 to 572°F): Accuracy is not guaranteed.
	K, J, E, T, N inputs, less than 0°C (32°F): Within $\pm 0.4\%$ of input span ± 1 digit
RTD:	Within $\pm 0.1\%$ of each input span ± 1 digit, or within $\pm 1^\circ\text{C}$ (2°F), whichever is greater
Direct current:	Within $\pm 0.2\%$ of each input span ± 1 digit
DC voltage:	Within $\pm 0.2\%$ of each input span ± 1 digit

Input sampling period: 250 ms

Input	Thermocouple: K, J, R, S, B, E, T, N, PL-II, C (W/Re5-26)
	External resistance, 100 Ω max.
	(However, B input: External resistance, 40 Ω max.)
	RTD: Pt100, JPt100, 3-wire system
	Allowable input lead wire resistance (10 Ω max. per wire)
	Direct current: 0 to 20 mA DC, 4 to 20 mA DC
	Input impedance: 50 Ω
	Allowable input current: 50 mA max.
	DC voltage: 0 to 1 V DC Input impedance (1 M Ω minimum)
	Allowable input voltage (5 V DC max.)
	Allowable signal source resistance (2 k Ω max.)
	0 to 5 V DC, 1 to 5 V DC, 0 to 10 V DC Input impedance (100 k Ω minimum)
	Allowable input voltage (15 V DC max.)
	Allowable signal source resistance (100 Ω max.)

Control output OUT1

Relay contact:	1a, Control capacity: 3 A 250 V AC (resistive load)
	1 A 250 V AC (inductive load $\cos\phi=0.4$)
	Electrical life: 100,000 cycles
Non-contact voltage (For SSR drive):	12 V DC $\pm 15\%$, Max. 40 mA (short circuit protected)
Direct current:	4 to 20 mA DC, Load resistance, Max. 550 Ω

Alarm 1 output

Action:	ON/OFF action
Hysteresis:	0.1 to 100.0°C ($^\circ\text{F}$) (Factory default: 1.0°C)
	DC voltage, current inputs: 1 to 1000 (The placement of the decimal point follows the selection.)
Output:	Relay contact 1a
	Control capacity: 3 A 250 V AC (resistive load)
	Electrical life: 100,000 cycles

Control action

PID control (with AT function)

PI control: When derivative time is set to 0

PD control (with auto-reset function): When integral time is set to 0

P control (with auto-reset function): When derivative and integral time are set to 0.

ON/OFF control: When proportional band is set to 0 or 0.0

OUT1 proportional band: 0 to 1000°C (2000°F), 0.0 to 1000.0°C (1999.9°F) or 0.0 to 100.0% (ON/OFF control when set to 0 or 0.0) (Factory default: 10°C)

Integral time: 0 to 1000 seconds (OFF when set to 0) (Factory default: 200 seconds)

Derivative time: 0 to 300 seconds (OFF when set to 0) (Factory default: 50 seconds)

OUT1 proportional cycle: 1 to 120 seconds (Factory default: 30 seconds for Relay contact, 3 seconds for Non-contact voltage, Not available for Direct current)

ARW: 0 to 100% (Factory default: 50%)

OUT1 ON/OFF hysteresis: 0.1 to 100.0°C (°F) (Factory default: 1.0°C)

DC voltage, current inputs: 1 to 1000 (The placement of the decimal point follows the selection.)

OUT1 high limit: 0 to 100% (Direct current: -5 to 105%) (Factory default: 100%)

OUT1 low limit: 0 to 100% (Direct current: -5 to 105%) (Factory default: 0%)

Circuit insulation configuration

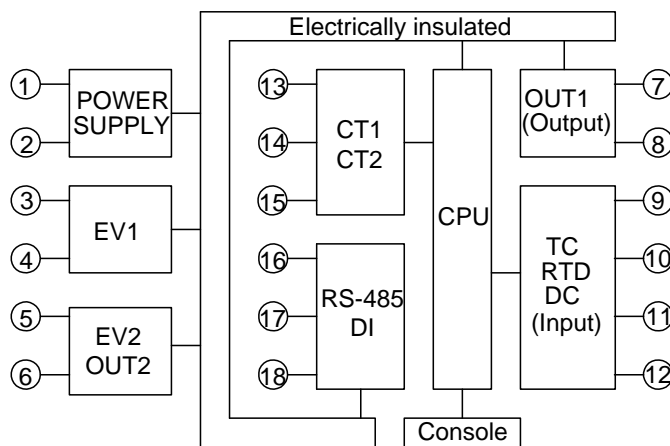

When OUT1 is a non-contact voltage or Direct current and OUT2 is a non-contact voltage, OUT1 is not electrically insulated from OUT2.

When OUT1 is a non-contact voltage or Direct current, OUT1 is not electrically insulated from RS-485, DI.

When OUT2 is a non-contact voltage, OUT2 is not electrically insulated from RS-485, DI.

Insulation resistance: 10 MΩ minimum, at 500 V DC

Dielectric strength: 1.5 kV AC for 1 minute between input terminal and power terminal
1.5 kV AC for 1 minute between output terminal and power terminal

Supply voltage: 100 to 240 V AC 50/60 Hz, 24 V AC/DC 50/60 Hz
Allowable voltage fluctuation: 100 to 240 V AC: 85 to 264 V AC,
24 V AC/DC: 20 to 28 V AC/DC

Power consumption: Approx. 8 VA

Ambient temperature: 0 to 50°C (32 to 122°F) (No icing and non-condensing)

Ambient humidity: 35 to 85 %RH (Non-condensing)

Altitude: 2,000 m or less

Weight: Approx. 120 g

External dimensions: 48 x 48 x 62 mm (W x H x D)

(Depth of control panel interior when gasket A is used: 54.5 mm)

(Depth of control panel interior when gasket A is not used: 56.0 mm)

Material: Flame-resistant resin (Case)

Color: Black (Case)

Drip-proof/Dust-proof: IP66 (for front panel only)

Attached functions:

[Power failure countermeasure]

The setting data is backed up in the non-volatile IC memory.

[Self-diagnosis]

The CPU is monitored by a watchdog timer, and if an abnormal status occurs, the controller is switched to warm-up status, turning all outputs OFF.

[Automatic cold junction temperature compensation] (Only thermocouple input type)

This detects the temperature at the connecting terminal between the thermocouple and the instrument, and always maintains it at the same status as if the reference junction location temperature were at 0°C (32°F).

[Warm-up indication]

After the power supply to the instrument is turned on, the PV Display indicates the sensor input type, and SV Display indicates input range high limit value (for thermocouple, RTD) or Scaling high limit value (for DC voltage, current inputs) for approximately 3 seconds.

[Indication range and Control range]

Thermocouple input: [Input range low limit value – 50°C(100°F)] to [Input range high limit value + 50°C(100°F)]

RTD input: [Input range low limit value – Input span x 1%] to [Input range high limit value + 50°C(100°F)]

DC voltage, current inputs:

[Scaling low limit value – Scaling span x 1%] to [Scaling high limit value + Scaling span x 10%]

[Burnout]

When the thermocouple or RTD input is burnt out, OUT1 and OUT2 are turned OFF (for Direct current output type, OUT1 low limit value), and the PV Display flashes [- - - -].

However, for the manual control, the preset MV is output.

When the DC voltage or current input is disconnected, PV Display flashes [- - - -] for 4 to 20 mA DC and 1 to 5 V DC inputs, and [- - - -] for 0 to 1 V DC input. For 0 to 20 mA DC, 0 to 5 V DC and 0 to 10 V DC inputs, the PV Display indicates the value corresponding with 0 mA or 0 V input.

[Input error indication]

Output status when input errors occur	Contents and Indication	Output status			
		OUT1		OUT2	
		Direct(Cooling) action	Reverse(Heating) action	Direct(Cooling) action	Reverse(Heating) action
ON	Overscale Measured value has exceeded Indication range high limit value. [- - - -] flashes.	ON (20 mA) or OUT1 high limit value (*)	OFF (4 mA) or OUT1 low limit value	OFF or OUT2 low limit value	ON or OUT2 high limit value (*)
OFF		OFF (4 mA) or OUT1 low limit value			OFF or OUT2 low limit value
ON	Underscale Measured value has dropped below Indication range low limit value. [- - - -] flashes.	OFF (4 mA) or OUT1 low limit value	ON (20 mA) or OUT1 high limit value (*)	ON or OUT2 high limit value (*)	OFF or OUT2 low limit value
OFF			OFF (4 mA) or OUT1 low limit value	OFF or OUT2 low limit value	

[Output status when input errors occur] can be used only for controllers using Direct current and voltage inputs, and Direct current output.

For manual control, the preset MV is output.

(*) Outputs a value between OFF (4 mA) and ON (20 mA), or between OUT1 (or OUT2) low limit value and OUT1 (or OUT2) high limit value, depending on deviation.

[Auto/Manual control switching]

Select "Auto/Manual control" in [OUT/OFF key function] in Setup Mode, then press the $\text{\textcircled{1}}$ key in PV/SV Display Mode. Auto/manual control can be switched.

[Console communication]

By connecting the USB communication cable (Model CMA) to the Console connector of the ACS-13A, the following operations can be conducted from an external computer using the Console software SWS-ACS01M.

- (1) Reading and setting of SV, PID and various set values,
- (2) Reading of PV and action status,
- (3) Function change

Console communication and Serial communication (C5 option) cannot be used together.

Communication interface: C-MOS level

Accessories included:

Mounting frame 1 piece, Gasket A (Front mounted to the ACS-13A) 1 piece

Instruction manual (A3 unfolded, English/Japanese) 1 copy

CT (Current transformer):

CTL-6-S: 1 piece [W (20A) option] CTL-12-S36-10L1U: 1 piece [W (50A) option]

CTL-6-S: 2 pieces [W3 (20A) option] CTL-12-S36-10L1U: 2 pieces [W3 (50A) option]

Accessories sold separately: Terminal cover,

USB communication cable (CMA)

12.2 Optional Specifications

Alarm 2 output (Option code: A2)

If this option is ordered, Heating/Cooling control (D□ option) cannot be ordered.

Alarm 2 and Heater burnout alarm (W, W3 option) utilize common output terminals.

Action: ON/OFF action

Hysteresis: 0.1 to 100.0°C (°F) (Factory default: 1.0°C)

DC voltage, current inputs: 1 to 1000 (The placement of the decimal point follows the selection.)

Output: Relay contact 1a, Control capacity: 3 A 250 V AC (Resistive load), Electrical life: 100,000 cycles

Heater burnout alarm (including sensor burnout alarm) [Option code: W(20A), W(50A), W3(20A), W3(50A)]

Monitors heater current with CT (current transformer), and detects burnout.

This alarm is also activated when indication is overscale and underscale.

This option cannot be ordered to Direct current output type.

If this alarm is ordered, Heating/Cooling control (D□ option) cannot be ordered.

Heater burnout alarm and Alarm 2 (A2) option utilize common output terminals.

Rating: Single phase 20 A [W(20A)], Single phase 50 A [W(50A)],
3-phase 20 A [W3(20A)], 3-phase 50 A [W3(50A)] (Must be specified.)

Detects burnout with CT1 input for single phase, with CT1 and CT2 input for 3-phase.

Setting range: 20 A [W(20A)], [W3(20A)]: 0.0 to 20.0 A (OFF when set to 0.0)

50 A [W(50A)], [W3(50A)]: 0.0 to 50.0 A (OFF when set to 0.0)

Setting accuracy: Within ±5% of the rated value

Action: ON/OFF action

Output: Relay contact 1a, Control capacity: 3 A 250 V AC (resistive load), Electrical life: 100,000 cycles

Heating/Cooling control (Option code: D□)

If this option is ordered, Alarm 2 (A2) option and Heater burnout alarm [W(20A), W(50A), W3(20A), W3(50A) option] cannot be ordered.

The specifications of Heating side are the same as those of OUT1.

OUT2 proportional band: 0.0 to 10.0 times (Multiplied value of OUT1 proportional band)
(ON/OFF control when set to 0.0)

OUT2 integral time: Same as that of OUT1.

OUT2 derivative time: Same as that of OUT1.

OUT2 proportional cycle: 1 to 120 sec [Default: Relay contact (DR): 30 sec, Non-contact voltage (DS): 3 sec]

Overlap/Dead band setting range:

Thermocouple, RTD inputs: -100.0 to 100.0°C (°F)

DC voltage, current inputs: -1000 to 1000 (The placement of the decimal point follows the selection.)

OUT2 ON/OFF hysteresis

Thermocouple, RTD inputs : 0.1 to 100.0°C (°F) (Factory default: 1.0°C)

DC voltage, current inputs: 1 to 1000 (The placement of the decimal point follows the selection.)

OUT2 high limit: 0 to 100% (Factory default: 100%)

OUT2 low limit : 0 to 100% (Factory default: 0%)

OUT2 cooling method:

One cooling action can be selected from Air cooling (Linear characteristics), Oil cooling (1.5th power of the linear characteristics) and Water cooling (2nd power of the linear characteristics) by keypad operation.

Control output OUT2: DR: Relay contact 1a, Control capacity: 3 A 250 V AC (resistive load),
Electrical life: 100,000 cycles

DS: Non-contact voltage (for SSR) 12 V DC ± 15%, Max. 40 mA (short circuit protected)

Serial communication (Option code: C5)

If this option is ordered, the Set value memory external selection (SM option) cannot be ordered.

This option and Console communication cannot be used together.

The following operations can be carried out from an external computer.

- (1) Reading and setting of the SV, PID values and various set values
- (2) Reading of the PV and action status
- (3) Function change

Cable length: Max. 1.2 km
Cable resistance: Within 50 Ω
(Terminators are not necessary, but if used, use 120 Ω minimum on both sides)

Communication line: EIA RS-485

Communication method: Half-duplex communication

Communication speed: 2400/4800/9600/19200 bps (Selectable by keypad)
(Factory default: 9600 bps)

Synchronization method: Start-stop synchronization

Data bit/Parity: Data bit: 7 bits, 8 bits Parity: Even, Odd, No parity (Selectable by keypad)
(Factory default: 7 bits/Even)

Stop bit: 1 bit, 2 bits (Selectable by keypad) (Factory default: 1)

Communication protocol: Shinko protocol/MODBUS ASCII/MODBUS RTU (Selectable by keypad)
(Factory default: Shinko protocol)

Data format:

Communication protocol	Shinko Protocol	MODBUS ASCII	MODBUS RTU
Start bit	1	1	1
Data bit	7	7 (8) Selectable	8
Parity	Even	Even (No parity, Odd) Selectable	No parity (Even, Odd) Selectable
Stop bit	1	1 (2) Selectable	1 (2) Selectable

Number of connectable units: Maximum 31 units to 1 host computer

Communication error detection: Parity, checksum (Shinko protocol), LRC (MODBUS ASCII),
CRC-16 (MODBUS RTU)

Digital external setting: Step SV can be received from Shinko programmable controllers
PCA1 or PCB1. ('SV digital transmission' should be selected
in [Communication protocol] on the PCA1 or PCB1.)

Set value memory external selection (Option code: SM)

If this option is ordered, Serial communication (C5 option) cannot be ordered.

SV, SV2, SV3 or SV4 can be selected by the external contact.

The MEMO Display indicates the selected memory number.

In [Contact input function] of Setup Mode, Contact input terminal DI2 can be used for the 'Set value memory external selection' or for 'Control output OFF external selection 1 or 2'.

(Refer to 'Contact input function selection' on p.18.)

If 'Auto/Manual control function' is selected in [OUT/OFF key function] in Setup Mode, externally Auto/Manual control can be switched.

Circuit current when closed: Approx. 12 mA

13. Troubleshooting

If any malfunctions occur, refer to the following items after checking that power is being supplied to the controller.

13.1 Indication

Problem	Possible Cause and Solution
[FF], nothing or PV is indicated on the PV Display.	<ul style="list-style-type: none"> Control output OFF function is working. Press the  key for approx. 1 second to release the function.
[----] is flashing on the PV Display.	<ul style="list-style-type: none"> Burnout of thermocouple, RTD or disconnection of DC voltage (0 to 1 V DC) input. Change each sensor. How to check whether the sensor is burnt out [Thermocouple] If the input terminals of the instrument are shorted, and if a value around room temperature is indicated, the instrument is likely to be operating normally, however, the sensor may be burnt out. [RTD] If approx. 100 Ω of resistance is connected to the input terminals between A-B of the instrument and between B-B is shorted, and if a value around 0°C (32°F) is indicated, the instrument is likely to be operating normally, however, the sensor may be burnt out. [DC voltage (0 to 1 V DC)] If the input terminals of the instrument are shorted, and if a scaling low limit value is indicated, the instrument is likely to be operating normally, however, the signal wire may be disconnected. Check whether the input terminals of thermocouple, RTD or DC voltage (0 to 1 V DC) are securely mounted to the instrument input terminal. Connect the sensor terminals to the instrument input terminals securely.
[----] is flashing on the PV Display.	<ul style="list-style-type: none"> Check whether input signal wire for DC voltage (1 to 5 V DC) or Direct current (4 to 20 mA DC) is disconnected. How to check whether the input signal wire is disconnected [DC voltage (1 to 5 V DC)] If the input to the input terminals of the instrument is 1 V DC and if a scaling low limit value is indicated, the instrument is likely to be operating normally, however, the signal wire may be disconnected. [Direct current (4 to 20 mA DC)] If the input to the input terminals of the instrument is 4 mA DC and if a scaling low limit value is indicated, the instrument is likely to be operating normally, however, the signal wire may be disconnected. Check whether input signal wire for DC voltage (1 to 5 V DC) or current (4 to 20 mA DC) is securely connected to the instrument input terminals. Check if polarity of thermocouple or compensating lead wire is correct. Check that codes (A, B, B) of RTD agree with the instrument terminals.
The PV Display keeps indicating the value which was set in [Scaling low limit].	<ul style="list-style-type: none"> Check whether the input signal wire for DC voltage (0 to 5 V DC, 0 to 10 V DC) and Direct current (0 to 20 mA DC) is disconnected. How to check whether the input signal wire is disconnected [DC voltage (0 to 5 V DC, 0 to 10 V DC)] If the input to the input terminals of the instrument is 1 V DC and if a value (converted value from scaling high, low limit setting) corresponding to 1 V DC is indicated, the instrument is likely to be operating normally, however, the signal wire may be disconnected. [Direct current (0 to 20 mA DC)] If the input to the input terminals of the instrument is 4 mA DC and if a value (converted value from scaling high, low limit setting) corresponding to 4 mA DC is indicated, the instrument is likely to be operating normally, however, the signal wire may be disconnected. Check whether the input terminals for DC voltage (0 to 5 V DC, 0 to 10 V DC) or Direct current (0 to 20 mA DC) are securely connected to the instrument input terminals.

Problem	Possible Cause and Solution
The indication of PV Display is irregular or unstable.	<ul style="list-style-type: none"> • Check whether sensor input or temperature unit (°C or °F) is correct. Select the sensor input and temperature unit (°C or °F) correctly. • Sensor correcting value is unsuitable. Set it to a suitable value. • Check whether the specification of the sensor is correct. • AC leaks into the sensor circuit. Use an ungrounded type sensor. • There may be equipment that interferes with or makes noise near the controller. Keep the instrument clear of any potentially disruptive equipment.
[ERR 1] is indicated on the PV Display.	<ul style="list-style-type: none"> • Internal memory is defective. Contact our agency or us.

13.2 Key Operation

Problem	Possible Cause and Solution
<ul style="list-style-type: none"> • Unable to set the SV, P, I, D, proportional cycle or alarm value. • The values do not change by Δ, ∇ keys. 	<ul style="list-style-type: none"> • Set value lock (Lock 1 or Lock 2) is selected. Release the lock in [Set value lock]. • AT or auto-reset is performing. In the case of AT, cancel the AT. It takes approximately 4 minutes until auto-reset is finished.
The setting indication does not change in the input range even if the Δ , ∇ keys are pressed, and new values are unable to be set.	<ul style="list-style-type: none"> • Scaling high or low limit value in Setup Mode may be set at the point where the value does not change. Set it to a suitable value while in Setup Mode.

13.3 Control

Problem	Possible Cause and Solution
Temperature does not rise.	<ul style="list-style-type: none"> • Sensor is out of order. Replace the sensor. • Check whether the Sensor or control output terminals are securely mounted to the instrument input terminals. Ensure that the sensor or control output terminals are mounted to the instrument input terminals securely. • Check whether the wiring of sensor or control output terminals is correct.
The control output remains in an ON status.	<ul style="list-style-type: none"> • OUT1 or OUT2 low limit value is set to 100% or higher in Setup Mode. Set it to a suitable value.
The control output remains in an OFF status.	<ul style="list-style-type: none"> • OUT1 or OUT2 high limit value is set to 0% or less in Setup Mode. Set it to a suitable value.

For all other malfunctions, please contact our main office or dealers.

14. Character Table

The PV Display indicates setting (selection) characters, and the SV Display indicates factory default value.







[Main Setting Mode]

Character	Setting (Selection) Item, Setting Range	Data
4 0	SV Setting range: Scaling low limit to Scaling high limit	
42 7 0	SV2 Setting range: Scaling low limit to Scaling high limit	
43 7 0	SV3 Setting range: Scaling low limit to Scaling high limit	
44 7 0	SV4 Setting range: Scaling low limit to Scaling high limit	

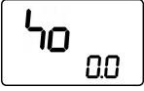







[Sub Setting Mode]

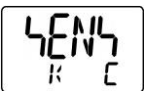

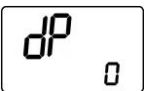

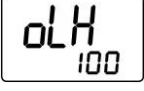





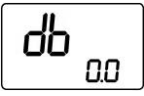

Character	Setting (Selection) Item, Setting Range	Data																				
	AT/Auto-reset -----: AT/Auto-reset Cancel AF□□ / REF: AT/Auto-reset Perform																					
	OUT1 proportional band Setting range: 0 to 1000°C (2000°F) Thermocouple, RTD inputs with decimal point: 0.0 to 1000.0°C(1999.9°F) DC voltage, current inputs: 0.0 to 100.0%																					
	OUT2 proportional band Setting range: 0.0 to 10.0 times (Multiplied value of OUT1 proportional band)																					
	Integral time Setting range: 0 to 1000 seconds																					
	Derivative time Setting range: 0 to 300 seconds																					
	ARW Setting range: 0 to 100%																					
	OUT1 proportional cycle Setting range: 1 to 120 seconds																					
	OUT2 proportional cycle Setting range: 1 to 120 seconds																					
	Alarm 1 value <table border="1" style="width: 100%; border-collapse: collapse;"> <thead> <tr> <th>Alarm Type</th> <th>Setting Range</th> </tr> </thead> <tbody> <tr> <td>High limit alarm</td> <td>-(Input span) to Input span°C (°F) *1</td> </tr> <tr> <td>Low limit alarm</td> <td>-(Input span) to Input span°C (°F) *1</td> </tr> <tr> <td>High/Low limits alarm</td> <td>0 to Input span°C (°F) *1</td> </tr> <tr> <td>H/L limit range alarm</td> <td>0 to Input span°C (°F) *1</td> </tr> <tr> <td>Process high alarm</td> <td>Input range low limit to Input range high limit *2</td> </tr> <tr> <td>Process low alarm</td> <td>Input range low limit to Input range high limit *2</td> </tr> <tr> <td>High limit with standby</td> <td>-(Input span) to Input span°C (°F) *1</td> </tr> <tr> <td>Low limit with standby</td> <td>-(Input span) to Input span°C (°F) *1</td> </tr> <tr> <td>H/L limits with standby</td> <td>0 to Input span°C (°F) *1</td> </tr> </tbody> </table> <p>*1:For DC voltage, current inputs, the input span is the same as the scaling span. *2: For DC voltage, current inputs, input range low (or high) limit value is the same as scaling low (or high) limit value.</p>	Alarm Type	Setting Range	High limit alarm	-(Input span) to Input span°C (°F) *1	Low limit alarm	-(Input span) to Input span°C (°F) *1	High/Low limits alarm	0 to Input span°C (°F) *1	H/L limit range alarm	0 to Input span°C (°F) *1	Process high alarm	Input range low limit to Input range high limit *2	Process low alarm	Input range low limit to Input range high limit *2	High limit with standby	-(Input span) to Input span°C (°F) *1	Low limit with standby	-(Input span) to Input span°C (°F) *1	H/L limits with standby	0 to Input span°C (°F) *1	
Alarm Type	Setting Range																					
High limit alarm	-(Input span) to Input span°C (°F) *1																					
Low limit alarm	-(Input span) to Input span°C (°F) *1																					
High/Low limits alarm	0 to Input span°C (°F) *1																					
H/L limit range alarm	0 to Input span°C (°F) *1																					
Process high alarm	Input range low limit to Input range high limit *2																					
Process low alarm	Input range low limit to Input range high limit *2																					
High limit with standby	-(Input span) to Input span°C (°F) *1																					
Low limit with standby	-(Input span) to Input span°C (°F) *1																					
H/L limits with standby	0 to Input span°C (°F) *1																					
	Alarm 2 value The setting range is the same as that of Alarm 1 value.																					
	Heater burnout alarm value Rated current: 20 A (0.0 to 20.0 A), 50 A (0.0 to 50.0 A)																					
	Heater burnout alarm 2 value Rated current: 20 A (0.0 to 20.0 A), 50 A (0.0 to 50.0 A)																					







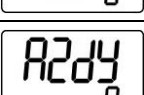

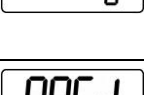

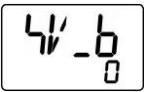

[Auxiliary Function Setting Mode]

Character	Setting (Selection) Item, Setting Range	Data
	Set value lock <ul style="list-style-type: none"> • ---- (Unlock): All set values can be changed. Loc 1 (Lock 1): None of the set values can be changed. Loc 2 (Lock 2): Only Main Setting Mode can be changed. Loc 3 (Lock 3): All set values except Input type can be changed. <p>However, changed values revert to their previous value after power is turned off because they are not saved in the non-volatile IC memory. Do not change any setting item in Setup Mode. If any item in Setup Mode is changed, it will affect other setting items such as the SV and Alarm value.</p>	
	Sensor correction Setting range: -100.0 to 100.0°C (°F) DC voltage, current inputs: -1000 to 1000	
	Communication protocol NoML: Shinko protocol ModA: MODBUS ASCII mode ModR: MODBUS RTU mode	
	Instrument number Setting range: 0 to 95	
	Communication speed <input type="checkbox"/> 24: 2400 bps <input type="checkbox"/> 48: 4800 bps <input type="checkbox"/> 96: 9600 bps <input type="checkbox"/> 192: 19200 bps	
	Data bit/Parity 8NoN: 8 bits/No parity 7NoN: 7 bits/No parity 8EVN: 8 bits/Even parity 7EVN: 7 bits/Even parity 8odd: 8 bits/Odd parity 7odd: 7 bits/Odd parity	
	Stop bit <input type="checkbox"/> 1: 1 bit <input type="checkbox"/> 2: 2 bits	

[Setup Mode]

Character	Setting (Selection) Item, Setting Range	Data
	Input type K□□C: K -200 to 1370°C K□□F: K -320 to 2500°F K□.C: K -200.0 to 400.0°C K□.F: K -320.0 to 750.0°F J□□C: J -200 to 1000°C J□□F: J -320 to 1800°F R□□C: R 0 to 1760°C R□□F: R 0 to 3200°F S□□C: S 0 to 1760°C S□□F: S 0 to 3200°F B□□C: B 0 to 1820°C B□□F: B 0 to 3300°F E□□C: E -200 to 800°C E□□F: E -320 to 1500°F T□□C: T -200.0 to 400.0°C T□□F: T -320.0 to 750.0°F N□□C: N -200 to 1300°C N□□F: N -320 to 2300°F PL2C: PL-II 0 to 1390°C PL2F: PL-II 0 to 2500°F C□□C: C(W/Re5-26) 0 to 2315°C C□□F: C(W/Re5-26) 0 to 4200°F Pt1C: Pt100 -200.0 to 850.0°C Pt1F: Pt100 -320.0 to 1500.0°F JPt1C: JPt100 -200.0 to 500.0°C JPt1F: JPt100 -320.0 to 900.0°F Pt1C: Pt100 -200 to 850°C Pt1F: Pt100 -320 to 1500°F JPt1C: JPt100 -200 to 500°C JPt1F: JPt100 -320 to 900°F 420A: 4 to 20 mA DC -2000 to 10000 020A: 0 to 20 mA DC -2000 to 10000 0□1V: 0 to 1 V DC -2000 to 10000 0□5V: 0 to 5 V DC -2000 to 10000 1□5V: 1 to 5 V DC -2000 to 10000 0□10V: 0 to 10 V DC -2000 to 10000	
	Scaling high limit Setting range: Scaling low limit to Input range high limit DC voltage, current inputs: -2000 to 10000	
	Scaling low limit Setting range: Input range low limit to Scaling high limit DC voltage, current inputs: -2000 to 10000	
	Decimal point place □□□□: No decimal point □□□□: 1 digit after decimal point □□□□: 2 digits after decimal point □□□□: 3 digits after decimal point	
	PV filter time constant Setting range: 0.0 to 10.0 seconds	
	OUT1 high limit Setting range: OUT1 low limit to 100% Direct current output: OUT1 low limit to 105%	
	OUT1 low limit Setting range: 0% to OUT1 high limit value Direct current output: -5% to OUT1 high limit value	
	OUT1 ON/OFF hysteresis 0.1 to 100.0°C (°F) DC voltage, current inputs: 1 to 1000	
	OUT2 cooling method AI R□: Air cooling (Linear characteristics) oI L□: Oil cooling (1.5 th power of the linear characteristics) WAF□: Water cooling (2 nd power of the linear characteristics)	

Character	Setting (Selection) Item, Setting Range	Data
	OUT2 high limit Setting range: OUT2 low limit to 100%	
	OUT2 low limit Setting range: 0% to OUT2 high limit value	
	Overlap band/Dead band Setting range: -100.0 to 100.0°C(°F) DC voltage, current inputs: -1000 to 1000	
	OUT2 ON/OFF hysteresis Setting range: 0.1 to 100.0°C(°F) DC voltage, current inputs: 1 to 1000	
	Alarm 1 type ----: No alarm action H---: High limit alarm L---: Low limit alarm HL---: High/Low limits alarm HL d0: High Low limit range alarm R4---: Process high alarm RR4---: Process low alarm H---W: High limit with standby alarm L---W: Low limit with standby alarm HL---W: High/Low limits with standby alarm	
	Alarm 2 type Alarm types are the same as those of Alarm 1 type.	
	Alarm 1 Energized/De-energized NoML: Energized REV4: De-energized	
	Alarm 2 Energized/De-energized Selection items are the same as those of Alarm 1 Energized/De-energized.	
	Alarm 1 hysteresis Setting range: 0.1 to 100.0°C(°F) DC voltage, current inputs: 1 to 1000	
	Alarm 2 hysteresis Setting range: 0.1 to 100.0°C(°F) DC voltage, current inputs: 1 to 1000	
	Alarm 1 delay time Setting range: 0 to 10000 seconds	
	Alarm 2 delay time Setting range: 0 to 10000 seconds	
	SV rise rate Setting range: 0 to 10000 °C/minute (°F/minute) Thermocouple, RTD input with decimal point: 0.0 to 1000.0 °C/minute(°F/minute) DC voltage, current inputs: 0 to 10000/minute	
	SV fall rate Setting range: 0 to 10000°C/minute (°F/minute) Thermocouple, RTD input with decimal point: 0.0 to 1000.0 °C/minute (°F/minute) DC voltage, current inputs: 0 to 10000/minute	

Character	Setting (Selection) Item, Setting Range	Data
	Direct/Reverse control action HEAT: Reverse (Heating) control action COOL: Direct (Cooling) control action	
	AT bias Setting range: 0 to 50°C (0 to 100°F) Thermocouple, RTD inputs with decimal point: 0.0 to 50.0°C (0.0 to 100.0°F)	
	SVTC bias Setting range: Converted value of ±20% of the input span DC voltage, current inputs: ±20% of Scaling span	
	Contact input function 4M: Set value memory external selection OUT: Control output OFF external selection 1 (SV, SV2 switchable) OUT2: Control output OFF external selection 2	
	Output status when input errors occur OFF: Outputs OFF (4 mA) or OUT1 (OUT2) low limit value. ON: Outputs a value between OFF (4 mA) and ON (20 mA), or between OUT1 (OUT2) low limit value and OUT1 (OUT2) high limit value, depending on deviation.	
	OUT/OFF key function OFF: Control output OFF function MANU: Auto/Manual control function	
	Backlight selection ALL: All (displays and indicators) are backlit. PV: PV Display is backlit. 4V: SV Display is backlit. AC: Action indicators are backlit. PV4V: PV and SV Displays are backlit. PVAC: PV Display and Action indicators are backlit. 4VAC: SV Display and Action indicator are backlit.	
	PV color GRN: Green RED: Red ORC: Orange ALGR: When Alarm 1 or Alarm 2 is ON, PV color turns from green to red. ALOR: When Alarm 1 or Alarm 2 is ON, PV color turns from orange to red. PVGR: PV color changes continuously (Orange → Green → Red). APGR: PV color changes continuously (Orange → Green → Red) at the same time Alarm 1 or Alarm 2 is ON (Red).	
	PV color range Setting range: 0.1 to 100.0°C(°F) For DC voltage, current inputs: 1 to 1000	
	Backlight time Setting range: 0 to 99 minutes	
	Indication when output OFF OFF: OFF indication ROFF: No indication PV: PV indication PVAL: PV indication+ Alarm output (Alarm 1, Alarm 2, Heater burnout alarm) active	
	OUT1 rate-of-change Setting range: 0 to 100 %/second	

***** Inquiries *****

For any inquiries about this unit, please contact our agency or the vendor where you purchased the unit after checking the following.

(Example)

- Model ----- ACS-13A-R/M
- Option ----- A2, C5
- Serial number ----- No. 123456789

In addition to the above, please let us know the details of the malfunction, or discrepancy, and the operating conditions.

SHINKO TECHNOS CO., LTD.
OVERSEAS DIVISION

Head Office: 2-5-1, Senbahigashi, Minoo, Osaka, 562-0035, Japan

[URL] <https://shinko-technos.co.jp/e/>

Tel: +81-72-727-6100

[E-mail] overseas@shinko-technos.co.jp

Fax: +81-72-727-7006