

Preface

Thank you for purchasing our DSW-100-H, Indoor Humidity Sensor.

This manual contains instructions for installation and handling of the DSW-100-H. To ensure safe and correct use, thoroughly read and understand this manual before using this sensor. To prevent accidents arising from the misuse of this sensor, please ensure the operator receives this manual.

Notes

- This sensor should be used in accordance with the specifications described in the manual. If it is not used according to the specifications, it may malfunction or cause a fire.
- Be sure to follow all of the warnings, cautions and notices. If they are not observed, serious injury or malfunction may occur.
- The contents of this instruction manual are subject to change without notice.
- Care has been taken to ensure that the contents of this instruction manual are correct, but if there are any doubts, mistakes or questions, please inform our sales department.
- Any unauthorized transfer or copying of this document, in part or in whole, is prohibited.
- Shinko Technos Co., Ltd. is not liable for any damage or secondary damage(s) incurred as a result of using this product, including any indirect damage.

Safety Precautions (Be sure to read these precautions before using our products.)

The safety precautions are classified into 2 categories: "Warning" and "Caution".

Depending on the circumstances, procedures indicated by  Caution result in serious consequences, so be sure to follow the directions for usage.

Warning

Procedures which may lead to dangerous conditions and cause death or serious injury, if not carried out properly.

Caution

Procedures which may lead to dangerous conditions and cause superficial to medium injury or physical damage or may degrade or damage the product, if not carried out properly.

Warning

- To prevent an electrical shock or fire, only Shinko or other qualified service personnel may handle the inner assembly.
- To prevent an electrical shock, fire or damage to the instrument, parts replacement may only be undertaken by Shinko or other qualified service personnel.

SAFETY PRECAUTIONS

- To ensure safe and correct use, thoroughly read and understand this manual before using this instrument.
- This instrument is intended to be used for general equipment. Verify correct usage after purpose-of-use consultation with our agency or main office.
(Never use this instrument for medical purposes with which human lives are involved.)
- External protection devices must be installed, as malfunction of this product could result in serious damage to the system or injury to personnel. Proper periodic maintenance is also required.
- This instrument must be used under the conditions and environment described in this manual.
Shinko Technos Co., Ltd. does not accept liability for any injury, loss of life or damage occurring due to the instrument being used under conditions not otherwise stated in this manual.

Caution with Respect to Export Trade Control Ordinance

To avoid this instrument from being used as a component in, or as being utilized in the manufacture of weapons of mass destruction (i.e. military applications, military equipment, etc.), please investigate the end users and the final use of this instrument.

In the case of resale, ensure that this instrument is not illegally exported.

1. Model

1.1 Model

Model	Measurement Range	Output
DSW-100-H	5 to 90 %RH	4 to 20 mA DC 2-wire type
DSW-100-H W4		4 to 20 mA DC 4-wire type
DSW-100-HV W4		0 to 1 V DC 4-wire type

1.2 How to Read the Model Label

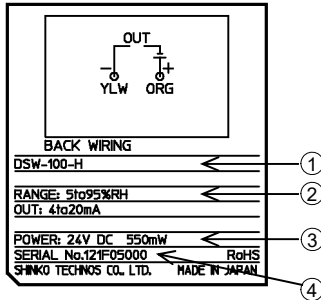

(Fig. 1.2-1)

Model label is attached to the inside of the case.

- ① Model
- ② Measurement range, Output
- ③ Power supply voltage, Power consumption
- ④ Serial number

2. Mounting

⚠ Caution

Installation site should be examined, giving careful consideration to the following conditions.

This sensor is designed for indoor use only. Do not install outside.

[This instrument is intended to be used under the following environmental conditions.]

- Free air flow
- A minimum of dust, and an absence of corrosive gases
- No flammable, explosive gases
- No mechanical vibrations or shocks
- No exposure to direct sunlight, an ambient temperature of 0 to 50°C (32 to 122°F) that does not change rapidly, and no icing
- An ambient non-condensing humidity of 5 to 90 %RH
- An absence of chlorinated and sulfidizing gases
- No large capacity electromagnetic switches or cables through which large current is flowing
- No water, oil, chemicals or the vapors of these substances can come into direct contact with the unit.

The 2-wire and 4-wire types of this sensor have internal heat generation due to their structure, and they are designed to minimize the effect. However, temperature errors may occur depending on the installation environment such as wind speed, power supply voltage, load resistance, temperature, and humidity. Please make corrections on the receiving instrument side according to the installation environment.

Inquiries

For any inquiries about this unit, please contact our agency or the vendor where you purchased the unit after checking the model and serial number. Please let us know the details of the malfunction, or discrepancy, and the operating conditions.

SHINKO TECHNOS CO., LTD. OVERSEAS DIVISION

Head Office: 2-5-1, Senbahigashi, Minoo, Osaka 562-0035, Japan

[URL] <https://shinko-technos.co.jp/e/>

Tel: +81-72-727-6100

[E-mail] overseas@shinko-technos.co.jp

Fax: +81-72-727-7006

(1) Fixing the Mounting Plate

Screw either (A) or (B), and fix the Mounting Plate to the outlet box, via outlet box cover located inside the wall.
For screws, use M4 screw (2 pieces) and spring washer provided.

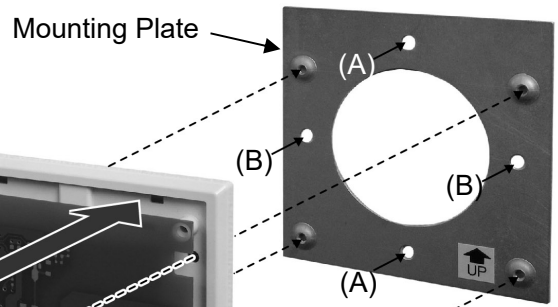

(2) Wiring

Connect the main unit lead wire to the wire from the wall side.

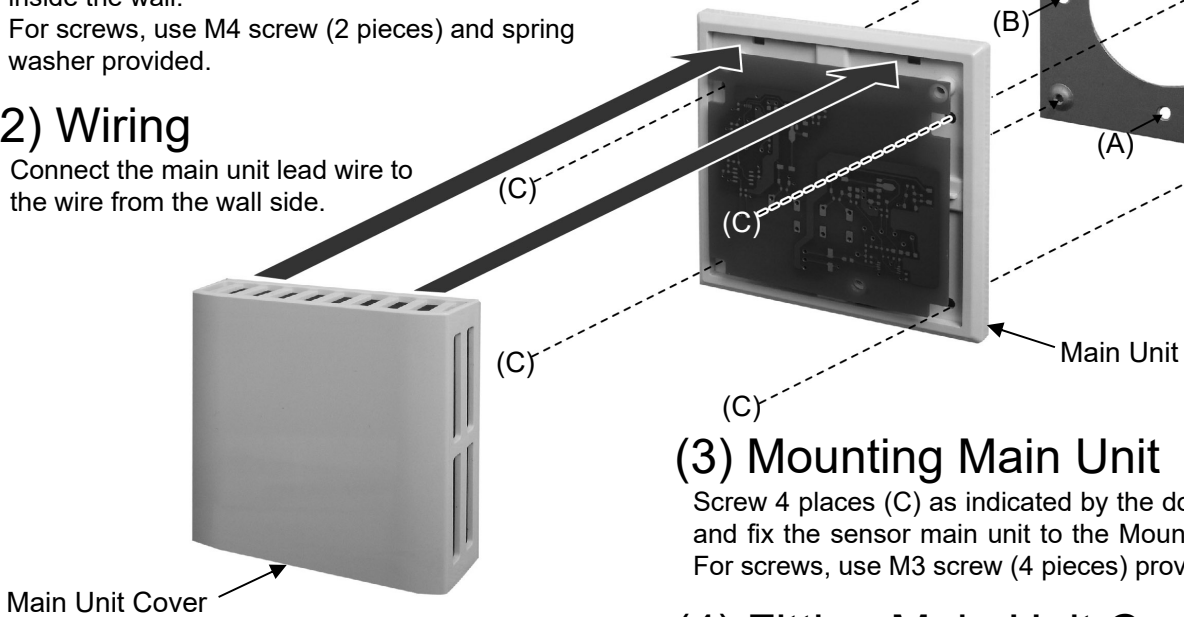

(3) Mounting Main Unit

Screw 4 places (C) as indicated by the dotted lines, and fix the sensor main unit to the Mounting Plate.
For screws, use M3 screw (4 pieces) provided.

(4) Fitting Main Unit Cover

Insert the main unit cover protrusion (2 places) into the cover mounting holes (2 places) located on the upper part of the sensor main unit, then fit the cover to the sensor main unit.

3. Wiring

DSW-100-H

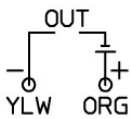

(Fig. 3-1)

DSW-100-H W4, DSW-100-HV W4

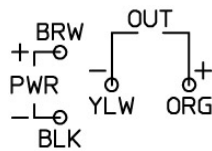

(Fig. 3-2)

Lead Wire Color	Lead Wire Type	
ORG: Orange	+	4 to 20 mA DC or
YLW: Yellow	-	0 to 1 V DC
BRW: Brown	+	Power supply
BLK: Black	-	

4. Replacing Humidity Sensor (HD-S2)

Follow the procedure below to replace the humidity sensor (HD-S2).

- Turn the power to the unit OFF, then remove the cover of the main unit.
- Pull the humidity sensor (HD-S2) out from the socket.
- Insert the new humidity sensor (HD-S2), with the model label facing downward.

[NOTE]

As the humidity sensor (HD-S2) is polarity sensitive, so be sure to insert the sensor correctly, otherwise the sensor will be broken, and measurement will be impossible.

Never disassemble the humidity sensor as it may lead to malfunction.

- Mount the main unit cover, then turn the power to the unit ON.

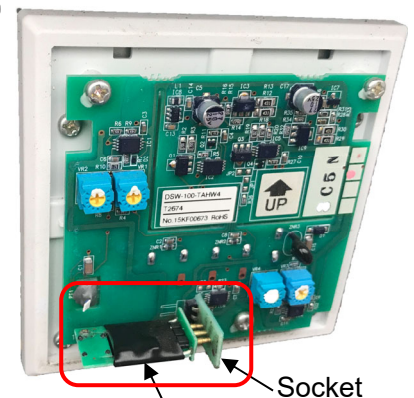

Humidity sensor (HD-S2)

5. Specifications

Measurement Range	5 to 90 %RH	
Output	4 to 20 mA DC (Linear conversion corresponding to 0 to 100 %RH) 2-wire or 4-wire type (Selectable) Maximum allowable load: 500 Ω max.	0 to 1 V DC (Linear conversion corresponding to 0 to 100 %RH) 4-wire type only Maximum allowable load: 500 Ω max.
Power Supply Voltage	24 V DC ± 10%	
Element Type	Electrostatic capacity change-type	
Mounting	To the outlet box (inside wall), via outlet box cover. Mounting dimension: 66.7 mm (JIS-C8340: 1999) (JIS: Japan Industrial Standards.)	
Material	Flame-resistant PC resin, Color: White	
Wiring	Lead wire: 300 mm Cross-section area: 0.5 mm ² See "3. Wiring" for details.	
External Dimensions	W90 x H90 x D32 mm (excluding lead wire) 	
Weight	Approx. 90 g	
Performance	Accuracy ± 5 %RH (at 5 to 45°C) Out of range 5 to 45°C: Max. ± 8 %RH Under the conditions of: Input power supply: 24 V, Load resistance: 250 Ω, Wind velocity: 0.15 m/s, Warm-up period: 60 minutes The output accuracy will be affected if the conditions above are changed. [Caution] The accuracy of this sensor is the value at the time of shipment. It is affected by wind speed, power supply voltage, load resistance, temperature, and humidity.	Response characteristics Approx. 20 seconds [Time to reach 90% of the RH value when the RH shifts between 30 ↔ 85 %RH. However, airflow 5 l/min (0.16 m/s)] (Waterproof filter attached) Hysteresis: Approx. 0 %RH (Stabilization time: 20 minutes)
Power Consumption	Approx. 550 mW (2-wire type) Approx. 3 W (4-wire type)	
Operating Environment	Temperature: 0 to 50°C Humidity: 5 to 90 %RH (non-condensing) [Caution] Do not use this sensor in an environment where dew condensation occurs. Do not use this sensor in an environment where chlorinated and sulfidizing gases are being generated.	
Storage Environment	Temperature: -20 to 60°C Humidity: 5 to 90 %RH (non-condensing)	
Insulation Resistance	Between Case - Output: 500 MΩ minimum, at 500 V DC	
Dielectric Strength	Between Case - Output: 1.5 kV for 1 minute, 3 mA max.	
Accessories	Mounting plate, Mounting plate screw: M4 x 8 (2 pieces), Spring washer (2 pieces) Sensor main unit mounting screw: M3 x 4 (4 pieces), Instruction manual: 1 copy	
Environmental Spec	RoHS directive compliant	